

STANLEY®



ONE TOOL COMPANY



PERFORMANCE IN ACTION™

**ACHIEVING
UNPARALLELED
PERFORMANCE
WITH STANLEY[®] TOOLS**

Since 1843

FULL RANGE OF PRODUCTS FOR ALL PROFESSIONALS

ONE TOOL COMPANY



POWER TOOLS



POWER TOOLS ACCESSORIES



HAND TOOLS



MECHANIC TOOLS



STORAGE



LASER MEASUREMENT

THE HISTORY OF STANLEY® TOOLS

1843

The Stanley Works was founded in New Britain, Connecticut by Frederick T. Stanley.



1863

Stanley introduced hammers to their line-up.



1870

Stanley began manufacturing screwdrivers and hand planes.

1900

Rule & Level is the largest manufacturer of planes and related tools in the world.

1911

Stanley began manufacturing chisels and vises.

1921

A new logo is introduced to symbolize the merger of the Stanley Rule & Level Company and the Stanley Works.



1936

Stanley manufactured its first utility knife.



1937

Henry Phillips, inventor of Phillips head screw, chose Stanley as the first company to begin making Phillips screwdrivers.

1844

Begin to manufacture ivory and boxwood rules.

1857

Stanley Rule & Level Company established by Henry Stanley. Stanley begins to manufacture levels and squares.

1876

Miter boxes were introduced.

1869

Purchased Bailey, Chaney and Company and acquired the right to manufacture tools under Bailey's patents.



1924

Stanley filed a patent for the ratcheting screwdriver.

1930

Stanley made the first steel tape rule.



1928

The Stanley Works broke into the electric hand tools market with an electric drill, screwdriver and bench grinder.



1954

Time Magazine published a cover story titled "Do-It-Yourself – The New Million Dollar Hobby". Stanley was ideally positioned to benefit from this trend and quickly developed products for this new market.



1970

Stanley began producing manual staplers.

1999

Stanley launched the FatMax Tape Rule and the FatMax AntiVibe Hammer.



2008

Stanley re-introduces Sweetheart planes.

2013

Stanley launches the next generation of hand tools.

170 Anniversary

2015

Stanley newly launches power tools range.



1963

Stanley opens the largest hand tool plant in the world in New Britain, CT. The same year, they introduce the PowerLock Tape Rule.



1998

Stanley acquires ZAG Industries Lt., an Israeli maker of plastic storage products, including tool boxes.



2012

Stanley launches new logo and power tools.

STANLEY.

2014

Stanley 19" Metal won a good design award



**GOOD DESIGN
AWARD 2014**

2016 & Beyond

STANLEY will continue to introduce new and innovative products that will change the way we work today

1980

The Stanley Works was presented the American Eagle Award from the American Supply & Machinery Manufacturers' Associ., Inc. for its "unusual across-the-board quality".

STANLEY®

STANLEY® is the longest established and largest hand tool manufacturer in the world.

Since 1843, STANLEY® has become a leading name in hand tool industry; we've set the standard for excellence in everything we do. No company on earth has a stronger or more compelling history of delivering the hardworking, powerful and innovational tools that help professionals, tradesmen and consumers around the world.

Whether you're a retailer looking for the best quality products to offer your customers, or a skilled user looking for the best tools, STANLEY® is here to serve you.

STANLEY® GLOBAL PRESENCE

- 20+ Global manufacturing sites and labs with similar process and quality controls for consistent quality.



More than **500**
World's
First SKUs

A dense grid of various hand tools such as wrenches, sockets, and screwdrivers.

More than **150**
Patents

Technical line drawings of a hand tool and a power tool.

More than **150**
Prestigious
Awards

A collage of award logos including Men's Journal Gear of the Year, What's New, PopMech, and others.

CDP
A LIST
2015
CLIMATE

FORTUNE
WORLD'S MOST
ADMIRED
COMPANIES 2015

MOST
SUSTAINABLE

Dow Jones
Sustainability Index

Newsweek
GREEN RANKINGS
2015

FORTUNE
WORLD'S MOST
ADMIRED
COMPANIES 2016

FROM CONCEPT TO YOUR HANDS



For 170 years, STANLEY® manufacturing expertise has allowed us to provide the quality, performance and value that our customers demand. With facilities located at more than 30 global sites and labs, we are dedicated to continually testing, designing and improving our products to ensure quality and maximum performance and function.

INNOVATIVE DESIGN WITH GREAT FUNCTIONALITY

STANLEY® designs tools based on end user research and user insights. We are the pioneers in many tool categories and have created over 150 patented features focused on solving problems of the users.

TESTING & QUALITY CONTROL

We test our products in state of the art facilities, doing performance and life tests to ensure high performance, getting the job done quickly, longer unit life, less repair and maintenance, and convenience and comfort for the users.

STANLEY® WRENCHES

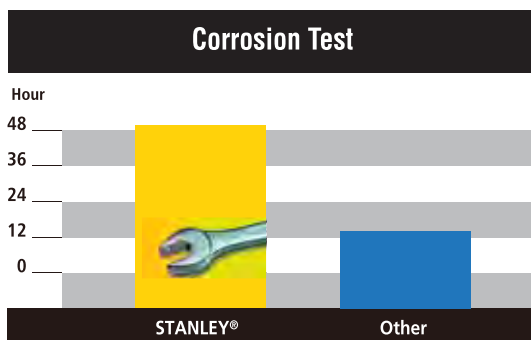

STANLEY® TOUGH CASE TAPE

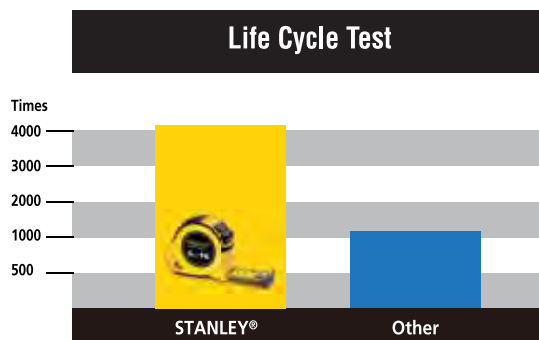

STANLEY® POWER TOOLS

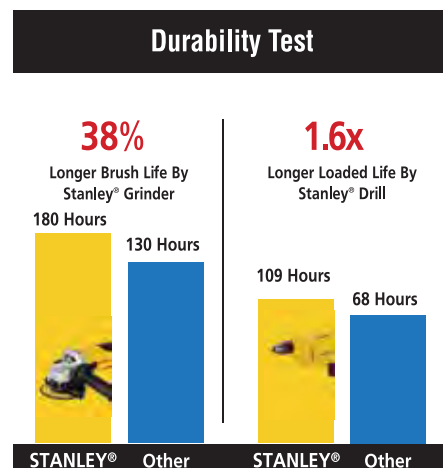
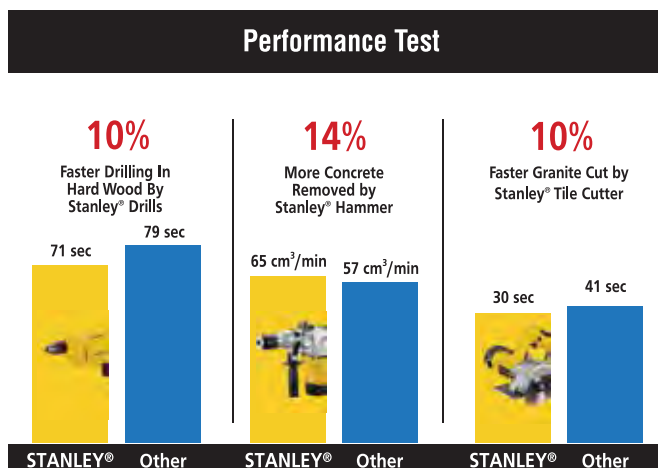



POWER TOOLS



DRILL

10



CORDLESS LITHIUM TOOLS

15



METALWORKING

22



CONCRETE

28



SAW&WOODWORKING

36

POWER TOOLS ACCESSORIES



BITS

14



ABRASIVE DISCS

26



DIAMOND BLADES&CHISELS

32



SAW BLADES

38

CONTENTS

HAND TOOLS & STORAGE



LASER MEASUREMENT 42



TRANSMODULE SYSTEM 214



MEASURING TOOLS 60



WRENCHES 220



LAYOUT TOOLS 72



**SOCKETS, WRENCHES,
MECHANIC TOOL SETS** 236



STORAGE SOLUTIONS 84



IMPACT SOCKETS 288



CUTTING TOOLS 108



TORQUE WRENCHES 306



CLAMPING TOOLS 132



AIR TOOLS 318



FASTENING TOOLS 156



SPECIALITY TOOLS&ACC 328



STRIKING TOOLS 190

PRODUCTS INDEX 334



FINISHING TOOLS 204

DISPLAY SELECTION 348

LEADING POWER TOOLS BRAND

Construction
Commercial and Industrial
Renovation
Facility Installation
Metal Fabrication



POWER TOOLS & ACCESSORIES



DRILL

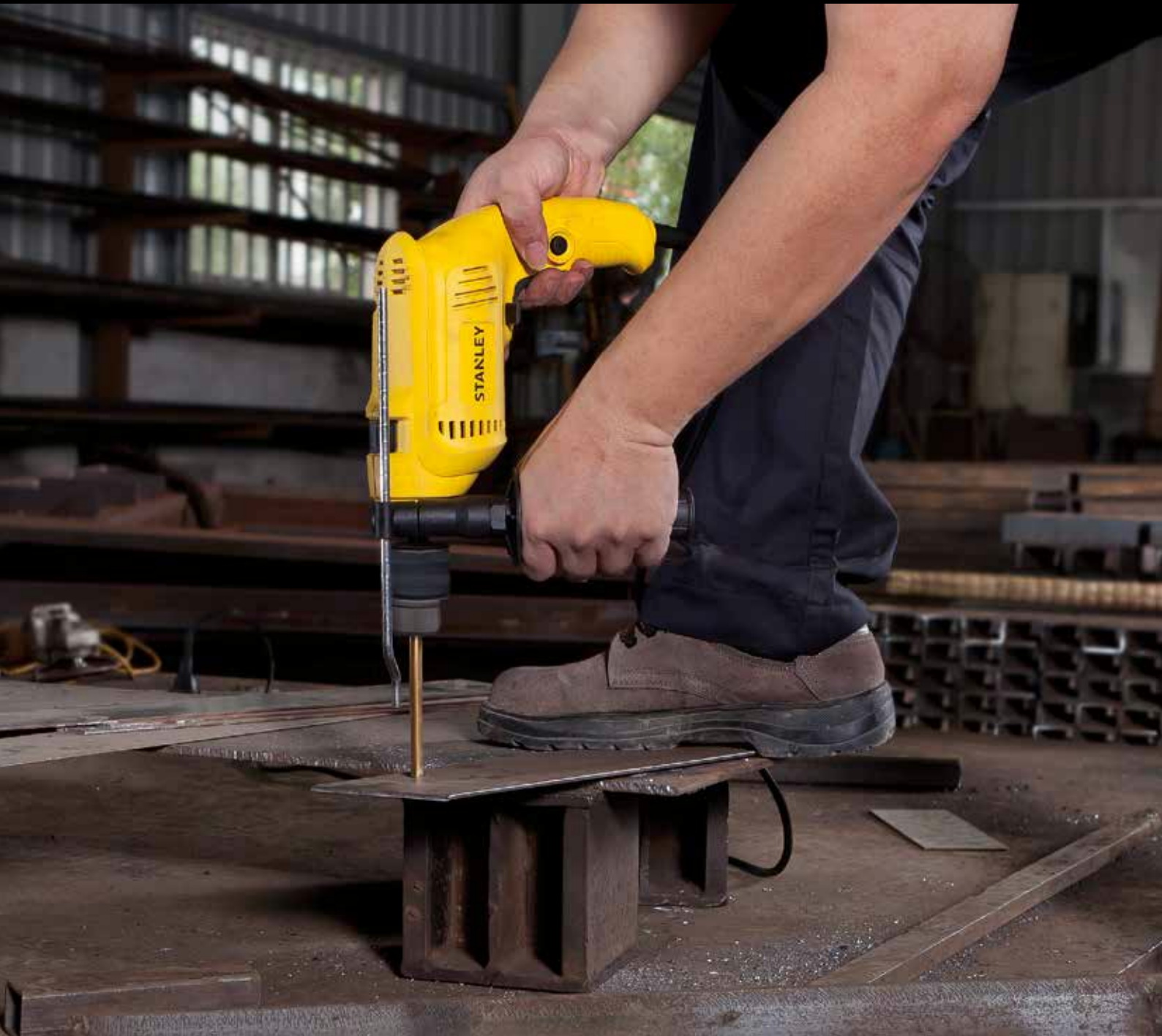

Tough jobs require durable and powerful tools. STANLEY®'s heavy duty keyed and keyless drills assist you with their high quality in every single situation. A metal gearcase and powerful square motor provide you with robustness and high performance. Well designed brushes lengthen the life-time of your tool dramatically.

PERFORMANCE IN ACTION™

ROTARY DRILL

SDR3006 6mm 300W Rotary Drill



- High performance motor delivering 0-4500RPM for faster work completion
- Best in class durability compared to tradesman competition
- Compact design & light weight for optimum handling in tight spaces

SPECIFICATIONS	
Rated Power	300W
Chuck size	6.5mm
No load speed	0-4,500 rpm
Variable Speed	yes
Lock on button	yes
Cable length	2m
Capacity on wood	15mm
Capacity on steel	6.5mm
Measured Weight (without cable)	0.95kg
Measured Size	200x165x60 mm

STEL101 10mm 400W Rotary Drill



- Heavy Duty Chuck Offers Great Durability And Safety
- Speed Dial Provides Quick And Consistent Torque Setting For Different Applications
- Lock-on Switch For User Convenience

SPECIFICATIONS	
Power	400W
Chuck	10mm Keyed
No Load Speed	0 -2700 rpm
Switch	2 Finger Variable speed
Reverse	Yes
Max. Drilling Capacity	
Steel	10mm
Wood	20mm
Cable Length	2m

STEL201 450W Impact Driver



- Powerful 450W Motor Delivers Max 146 Nm Torque
- Variable Speed Trigger Provides Control And Faster Application Speed
- One Touch Loading Chuck For Easy Accessory Changes

SPECIFICATIONS	
Power	450W
Chuck	6.35mm
No Load Speed	0 -2,900 rpm
Impact/Min	0-3,500 bpm
Max. Torque	146 Nm
Switch	2 Finger Variable speed
Reverse	Yes
Cable Length	2.2m

STDR5206 520W Screwdriver



- 520W Powerful Motor For Faster Screw Driving
- Easy Depth Adjustment For Quick And Consistent Driving
- Comfortable Handgrip Curve For One Hand Operation

SPECIFICATIONS	
Power	520W
Chuck	6.35mm
No Load Speed	0 -4,500 rpm
Switch	2 Finger Variable speed
Reverse	Yes
Steel	10mm
Cable Length	2m
Weight	1.4 Kg

STDR5510 10mm 550W Rotary Drill



- Ergonomically Shaped For Easy One Hand Operation
- 550W Powerful Motor Suitable For Aluminum Tapping And Hard Wood Drilling
- Long Durable Dust-Proof Ball Bearing And Support Bearing System Contribute Longer Durability
- Forward/Reverse Control Variable Speed Dial Offers Convenient And Accurate Speed And Torque Settings For Specified Application

SPECIFICATIONS

Power	550W
Chuck	1.5-10mm Keyed
No Load Speed	0 -2,800 rpm
Switch	2 Finger Variable speed
Reverse	Yes
Max. Drilling Capacity	
Steel	10mm
Wood	25mm
Cable Length	2.3m

HAMMER DRILL

SDH600 13mm 550W Hammer Drill



- Best in class Rotary & Impact Rate for most effective work output
- Light Weight and Compact & Ergonomic Design bring best control
- Speed Dial for consistent torque/speed
- Lock-on Switch for one hand control and user safety

SPECIFICATIONS

Input power (W)	550W
Chuck Size(mm)	1.5-13
No load Speed(RPM)	0-2900
Impact Rate(BPM)	0-49300
Forward And Reverse	Yes
Speed Dial	Yes
Chuck	Keyed & Keyless
Drilling Capacity(mm)	13(Metal), 13(Concrete), 25(Wood)
Weight (Kg)	1.75

SDH700 13mm 650W Hammer Drill



- Powerful Motor to get job done fast and easily
- Best in class Rotary & Impact Rate for most effective work output
- Light weight and Compact & Ergonomic Design bring best control
- Speed Dial for consistent torque/speed

SPECIFICATIONS

Input power (W)	650W
Chuck Size(mm)	1.5-13
No load Speed(RPM)	0-2900
Impact Rate(BPM)	0-49300
Forward And Reverse	Yes
Speed Dial	Yes
Chuck	Keyed & Keyless
Drilling Capacity(mm)	13(Metal), 13(Concrete), 30(Wood)
Weight (Kg)	1.87

STDH7213 13mm 720W Percussion Drill



- Robust 720 Watt Motor To Get Your Heavy Duty Job Done Easily
- High Working Efficiency Due To Excellent Rotary & Impact Speed
- Durable Metal Gear Housing For The Long Unit Life
- Speed Dial For All Different Applications

SPECIFICATIONS

Chuck Capacity	720W
No Load Speed	1.5-13mm
Max Capacity Wood/ Metal/ Concrete	32mm/13mm/16mm
Speed Dial	Yes
Chuck	Keyed
Reverse Mode	Yes
Weight	2.4 kg

STDH7213V 13mm 720W Percussion Drill Value Kit



Value Pack Including:

- 4pcs Wood Drill Bits: 4/5/6/8mm
- 5pcs Masonry Drill Bits: 4/5/6/8/10mm
- 4pcs Metal Drill Bits: 2/3/4/5/6mm
- 4pcs 25mm Phillips Screwdriver Bits: SL3/SL4/SL5/SL6
- 5pcs 25mm Slotted Screwdriver bits: PH0/PH1/PH3/PH2/PH2
- 7pcs 6.3mm Socket: 4/5/6/7/8/9/10mm
- 1pc 60mm Magnetic Nut Driver
- 1pc 25mm Socket Adapter
- 1pc Storage Rack,
- 1pc Multi-purpose Handle
- 1pc Knife
- 1pc Hammer
- 1pc Magnetic Torpedo Level
- 1pc Pliers
- 1pc Tape measure



MUD MIXER

SDR1400 1400W Mud Mixer



- Delivering 2 speed Variable speed with soft start for efficient mixing
- Power – Appropriate motor torque
- Multi-use for tradesman environment
- D-shape twin-handle design & light weight

SPECIFICATIONS

Power:	1400W
Speed Mode	2 Speed
No load speed	0-480rpm, 0-800rpm
Variable Speed	YES
Tool fitting / clamp thread	M14 X 2
Mixing paddle (Ø)	140mm
Mixture volume	120L
Cable	2m PVC cable
Soft start function	YES
Soft Grip on handle	YES
Accessories	1pc two-section paddle 2pcs 22# wrench
Packaging:	Color box
Weight(WORKING UNIT)	3.5Kg



Accessories - Bits



- Tungsten Carbide bit
- Elongated helix, quick evacuation
- Ideal for concrete and masonry



- Tungsten Carbide bit
- Elongated helix, quick evacuation
- Ideal for concrete and masonry

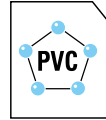

Concrete Drill Bits

Catalog Number	Measures mm	Measures in	Unit UPC	Master Pack Qty.	Master Pack UPC
STA53030C	3x60mm	1/8"x2 1/2"	7896525086727	100	17896525086724
STA53040C	4x75mm	5/32"x3"	7896525086734	100	17896525086731
STA53050C	5x85mm	3/16"x3 1/2"	7896525086741	100	17896525086748
STA53060C	6x100mm	15/64"x4"	7896525086758	100	17896525086755
STA53065C	6,5x100mm	1/4"x4"	7896525086765	100	17896525086762
STA53070C	7x100mm	9/32"x4"	7896525086772	100	17896525086779
STA53080C	8x120mm	5/16"x5"	7896525086789	50	17896525086786
STA53090C	9x120mm	11/32"x5"	7896525086796	50	17896525086793
STA53110C	10x120mm	3/8"x5"	7896525086802	50	17896525086809
STA53111C	11x150mm	7/16"x6"	7896525086819	50	17896525086816
STA53112C	12x150mm	15/32"x6"	7896525086826	50	17896525086823
STA53113C	13x150mm	1/2"x6"	7896525086833	50	17896525086830
STA53114C	14x150mm	9/16"x6"	7896525086840	50	17896525086847
STA53116C	16x150mm	5/8"x6"	7896525086857	50	17896525086854
STA53118C	18x160mm	11/16"x6 5/16"	7896525086864	50	17896525086861
STA53120C	20x160mm	3/4"x6 5/16"	7896525086871	50	17896525086878
STA54050C	5x150mm	3/16"x6"	7896525086888	50	17896525086885
STA54060C	6x150mm	15/64"x6"	7896525086895	50	17896525086892
STA54065C	6,5x150mm	1/4"x6"	7896525086901	50	17896525086908
STA54080C	8x150mm	5/16"x6"	7896525086918	50	17896525086915
STA54095C	10x150mm	3/8"x6"	7896525086925	50	17896525086922
STA56065C	6,5x200mm	1/4"x8"	7896525086932	20	17896525086939
STA56080C	8x300mm	5/16"x12"	7896525086949	20	17896525086946
STA56100C	10x300mm	3/8"x12"	7896525086956	20	17896525086953
STA56130C	13x300mm	1/2"x12"	7896525086963	15	17896525086960
STA56160C	16x300mm	5/8"x12"	7896525086970	15	17896525086977
STA56200C	20x300mm	3/4"x12"	7896525086987	15	17896525086984

HSS Metal Bit – Bulk Pack

PRODUCT FAMILY	SKU	DESCRIPTION	Qty Per Pack	Master pack qty	Bar codes
DRILLING	STA50004B10	HSS1mm Pack of (10)	10	280	5054905011536
DRILLING	STA50009B10	HSS1.5mm Pack of (10)	10	280	5054905011543
DRILLING	STA50014B10	HSS2mm Pack of (10)	10	280	5054905011550
DRILLING	STA50024B10	HSS2.5mm Pack of (10)	10	280	5054905011567
DRILLING	STA50029B10	HSS3mm Pack of (10)	10	280	5054905011574
DRILLING	STA50034B10	HSS3.2mm Pack of (10)	10	280	5054905011581
DRILLING	STA50039B10	HSS3.5mm Pack of (10)	10	280	5054905011598
DRILLING	STA50044B10	HSS4mm Pack of (10)	10	180	5054905011604
DRILLING	STA50059B10	HSS4.5mm Pack of (10)	10	180	5054905011611
DRILLING	STA50069B10	HSS5mm Pack of (10)	10	180	5054905011628
DRILLING	STA50074B10	HSS5.5mm Pack of (10)	10	180	5054905011635
DRILLING	STA50079B10	HSS6mm Pack of (10)	10	150	5054905011642
DRILLING	STA50089B10	HSS6.5mm Pack of (10)	10	150	5054905011659
DRILLING	STA50094B10	HSS7mm Pack of (10)	10	150	5054905011666
DRILLING	STA50099B10	HSS7.5mm Pack of (10)	10	150	5054905011673
DRILLING	STA50104B05	HSS8mm Pack of (5)	5	50	5054905012168
DRILLING	STA50109B05	HSS8.5mm Pack of (5)	5	50	5054905012175
DRILLING	STA50119B05	HSS9mm Pack of (5)	5	50	5054905012182
DRILLING	STA50124B05	HSS9.5mm Pack of (5)	5	50	5054905012199
DRILLING	STA50134B05	HSS10mm Pack of (5)	5	50	5054905012205
DRILLING	STA50139B05	HSS10.5mm Pack of (5)	5	50	5054905012212
DRILLING	STA50144B05	HSS11mm Pack of (5)	5	50	5054905012229
DRILLING	STA50149B05	HSS11.5mm Pack of (5)	5	50	5054905012236
DRILLING	STA50154B05	HSS12mm Pack of (5)	5	50	5054905012243
DRILLING	STA50159B05	HSS12.5mm Pack of (5)	5	50	5054905012250
DRILLING	STA50164B05	HSS13mm Pack of (5)	5	50	5054905012267

CORDLESS LITHIUM-ION TOOL



STANLEY® cordless drills are designed for strong performance, quality and precision.

The lithium-ion range also boasts about their compact size and light weight. Well suited for challenging drilling and screw driving tasks, the range is essential for the tradesman.

PERFORMANCE IN ACTION™

DRILL DRIVER

SCD12S2 10.8V Drill Driver



NEW

- Class leading drilling speed : 0-400/ 1500 RPM
- Powerful torque (26Nm) for drilling and screw driving
- 20 torque settings for precise control
- Powerful motor for longer durability
- Switch durability, chuck durability for minimum down time
- Durable battery and charger
- Compact design and light weight for easy handling
- Rubber handle for long duration fatigue free usage
- Variable switch on handle for better control
- LED for working in dark places

SPECIFICATIONS

Voltage (V)	10.8
Chuck capacity(mm)	0.8-10
No load speed	0-400/0-1500
Marked torque(Nm)	26
Actual Torque(Nm)	26
Clutch/ Torque Positions	20
Max drill diameter in wood(mm)	20
Max drill diameter in steel(mm)	10
Max screwdriver(mm)	8
Battery Type	Slide Pack
Battery size(Ah)	1.5
Charger (A)	1.25
Spindle lock	Yes
LED light	Yes
Over mold	Yes
Unit Weight	1

SCD20C2 18V Drill Driver



NEW

- Two speed transmission for optimal speed and torque control
- 29.4Nm of Torque ideal for drilling in wood and steel
- 24 Torque positions for effective screw driving
- Good ergonomics for better control
- Exceptional durability for less idle time

SPECIFICATIONS

Voltage	18/ 20V
No Load Speed	0-350/ 0-1500 Rpm
Battery	1.3Ah
Torque	45Nm
Chuck	13mm
Clutch Settings	23+1
Weight, Kg	1.6kg

STDC411LB 18V Drill Driver



- 2-Speed Gearbox: 0-400/0-1600 RPM
- New Contoured Overmold Grip And LED Work Light For User Convenience
- Battery Fuel Gauge Indicates The Remaining Power



SPECIFICATIONS

Voltage	18V
Amp Hour	1.5 Ah
Chuck Size	13 mm
Speed	0-400/1,600 bpm
Max. torque	30 Nm
Weight	1.5 kg

STDC1800 18V Drill Driver-Bare



- 2 Speed Gear Box (0-400/0-1,600) Delivers The Power Needed To Complete Large And Small Applications
- Metal Ratcheting Chuck Minimizes Bits Slipping In Chuck
- Battery Gauge Displays Charge Remaining In The Battery



SPECIFICATIONS

Voltage	18 V
Max Torque	30 Nm
Chuck Capacity	13mm
No Load Speed	0-400/0-1,600 rpm

STDC1802 18V Drill Driver



- High Performance Motor Delivers 330 Unit Watts Out
- 2 Speed Gear Box (0-400/0-1,600) Delivers The Power Needed To Complete Large And Small Applications
- Battery Gauge Displays Charge Remaining In The Battery
- LED Light Brightens Dark Work Areas



SPECIFICATIONS

Voltage	18 V
Amp Hour	2.0 Ah
Chuck Capacity	13mm
No Load Speed	0-400/0-1,600 rpm
Max Torque	30Nm
Weight	1.61 kg

IMPACT DRIVER

SCI12S2 10.8V Impact Driver



NEW

- 6.35mm Hex Quick Chuck Easy to change bits
- Powerful DC Motor Maximum Performance
- Bright LED Work Light Improve Visibility
- Ergonomics Handle Maximum Comfortable
- Variable Switch Easy to Control
- 1.5Ah Battery High Quality Cells

SPECIFICATIONS

Voltage	10.8V
Battery Capacity	1.5Ah
No Load Speed	0-2,500RPM
Beats Per Minute	0-3,200BPM
Bit Holder	6.35mm
Max. Torque	110Nm
Max. Bolt Diameter	M4-M12
Weight	1.0kg
Length X High	155x200mm

STDC441LB 18V Impact Driver



- High Performance Transmission Delivers 0-3,100 BPM For Quick Fastening Applications
- Quick Load Chuck Makes Bit Replacement Easier For User
- Battery Fuel Gauge Displays Remaining Power.
- LED Work Light Provides Better Visibility



SPECIFICATIONS

Voltage	18V
Amp Hour	1.5 Ah
Chuck Size	6.35 mm (Hex)
Speed	0-2,900 rpm
Impact/Min	0-3,100 bpm
Max. torque	164 Nm
Weight	1.5 kg

STCI1800 18V Impact Driver-Bare



- High Performance Transmission (0-2,900 RPM, 0-3,100 BPM) For Quick Fastening Applications
- Compact Tool Easily Fits In Tight Spaces And Reduces Fatigue
- Easy Load Chuck Allows User To Insert Bit With One Hand



SPECIFICATIONS

Voltage	18 V
Max Torque	164 Nm
Chuck Capacity	13mm
No Load Speed	0-400/0-1,600 rpm

STCI1802 18V Impact Driver



- High Torque Motor Delivers 164 Nm Of Torque
- High Performance Transmission (0-2,900 RPM, 0-3,100 BPM) For Quick Fastening Applications
- Compact Tool Easily Fits In Tight Spaces And Reduces Fatigue
- Easy Load Chuck Allows User To Insert Bit With One Hand
- Battery Fuel Gauge Displays Charge Remaining In The Battery
- LED Work Light Provides Additional Light In Dark Work Areas



SPECIFICATIONS

Voltage	18 V
Amp Hour	2.0 Ah
Chuck Size	6.35 mm (Hex)
Speed	0-2,900 rpm
Impact Per Min	0-3,100 bpm
Max. torque	164 Nm
Weight	1.45 kg

HAMMER DRILL DRIVER

SCH12S2 10.8V Hammer Drill Driver



NEW

- Class leading drilling speed : 0-400/ 1500 RPM
- Powerful torque (26Nm) for drilling and screw driving
- 20 torque settings for precise control
- Powerful motor for longer durability
- Switch durability, chuck durability for minimum down time
- Durable battery and charger
- Compact design and light weight for easy handling
- Rubber handle for long duration fatigue free usage
- Variable switch on handle for better control
- LED for working in dark places

SPECIFICATIONS

Voltage (V)	10.8
Chuck capacity(mm)	0.8-10
No load speed	0-400/0-1500
Impact Per Min	0-6000/0-22500
Max Torque(Nm)	26
Clutch/ Torque Positions	20
Max drill diameter in wood(mm)	20
Max drill diameter in steel(mm)	10
Max screwdriver(mm)	8
Battery size(Ah)	1.5
Charger (A)	1.25
LED light	Yes
Over mold	Yes
Unit Weight(kg)	1.1

SCH20C2 18V Hammer Drill Driver



NEW

- 283 MWO for medium to heavy applications
- 1,500 RPM for faster drilling and driving
- 25,500 BPM for speed of masonry applications
- COMPACT size for fitting in tight areas
- LIGHTWEIGHT 1.6 kg for less use fatigue
- 1.3ah BATTERIES for ample runtime

SPECIFICATIONS

Voltage	18V
Chuck	13mm
No Load Speed	0-350/ 0-1500
Torque Settings	22
Torque	50Nm
Impact Per Min	25500
Battery	1.3Ah
Charger	1A
Weight	1.6kg

STCT1872/1874 18V Hammer Drill



- High Performance Hammer Drill Delivers 27,200 BPM
- 2 Speed Gearbox (0-400) For High Torque Applications, (0-1600) For High Speed Applications
- Battery Gauge Displays Charge Remaining In The Battery
- LED Light Brightens Dark Work Areas

STCT1872 2 Pcs Batteries: 2.0Ah (KR)

STCT1874 2 Pcs Batteries: 2.0Ah & 4.0Ah (KR/TW)

SPECIFICATIONS

Voltage	18 V
No Load Speed	8000-18000 opm
Oscillating Angle	1.4° or 2.8°
Weight	1.4 kg

EXPANSION

STCT1810 18V Flash Light-Bare



- 4 LED Bulbs Delivers 120 Lumens For Working In Dark Conditions
- Pivoting Head Easily Adjusts Beam Towards Working Area
- Contoured Overmolded Handle Optimized For Increased Comfort

SPECIFICATIONS	
Voltage	18 V
Bulb	LED
Brightness	120 lumens
Weight	0.24kg

STCT1820 18V Reciprocating Saw-Bare



- Compact Design Allows Tool To Reach Tight Spaces
 - Tool Free Blade Release Allows For Quick And Easy Blade Changes
 - Variable-speed Trigger Provides More Control For Cutting A Variety Of Materials
 - Pivoting Shoe Helps Keep Constant Contact With Material
 - Contoured Overmolded Handle Optimized For Increased Comfort
- * STCT1822 with 2.0Ah Battery for China

SPECIFICATIONS	
Voltage	18 V
Strokes/Min	0-3,000 spm
Stroke Length	25mm
Keyless Blade Clamp	Yes
Variable-Speed Trigger	Yes
Weight	2.0kg

STCT1830 18V Oscillating Saw-Bare



- 2 Finger TOOL-FREE SYSTEM Makes Adjusting And Changing Accessories Quick And Easy
- Variable Speed Dial (8K-18K OPM) Offers Maximum Control Across a Variety Of Applications
- LED Work Light Provides Better Visibility In Darkened Work Conditions
- 3 Position Overmold Grip Improves Comfort By Reducing Vibration

SPECIFICATIONS	
Voltage	18 V
No Load Speed	8000-18000 opm
Oscillating Angle	1.4° or 2.8°
Weight	1.4 kg

STCT1840 18V 100mm Angle Grinder-Bare



- High-Performance Motor Produces 8,500 RPM For Aggressive Cutting, Removal And Finishing
- Cast Metal Gear Housing Helps Dissipate Heat During Extended Use
- Contoured Overmolded Handle Optimized For Increased Comfort
- Tool Free Guard Makes Guard Adjustments Quick And Easy

SPECIFICATIONS	
Voltage	18 V
No Load Speed	8500 rpm
Disc Size	100mm
Spindle Size	M10
Weight	2.0 kg

STCT1850 18V Circular Saw-Bare



- High-Performance Motor Delivers 4000 RPM For Aggressive Cutting
- Beveling Shoe Pivots Up To 50 Degrees For Non-Traditional Cutting Applications
- Contoured Overmolded Handle Optimized For Increased Comfort



SPECIFICATIONS

Voltage	18 V
No Load Speed	4000 rpm
Max. Blade Diameter	165 mm
Max. Cutting Depth	51 mm
Weight	2.9 kg

STCT1860 18V Jig Saw-Bare



- Tool-free Blade Release Allows For Quick And Easy Blade Changes
- 3 Orbital Settings Easily Adjusts Cut Aggressiveness Across Wide Range Of Applications
- Variable Speed Trigger (0-2,500 SPM) Provides Control For Clean And Accurate Cuts
- Beveling Shoe Provides Ability To Cut 0 To 45 Degree Bevel Cuts
- Contoured Overmolded Handle Optimized For Increased Comfort



SPECIFICATIONS

Voltage	18 V
No Load Speed	0-2500 spm
Stroke Length	19 mm
Max Capacity Wood/Metal	55/8 mm
Weight	2.6 kg

COMBO PACK

SCDI12S2 10.8V Drill Driver & Impact Driver Combo Kit



NEW

SPECIFICATIONS

Voltage	10.8V
Drill Driver	SCD12
Impact Driver	SCI12
Battery	1.5Ah

STCD1842K 18V Drill Driver & Impact Driver Combo Kit



NEW

SPECIFICATIONS

Voltage	18V
Drill Driver	STDC1800
Impact Driver	STCI1800
Battery	4.0Ah

STCD1843K 18V Hammer Drill & Impact Driver Combo Kit



SPECIFICATIONS

Voltage	18V
Hammer Drill	STCT1800
Impact Driver	STCI1800
Battery	4.0Ah

BATTERY



SCB12S
18V
1.5Ah



SCB20C
18V
2.0A



STBT18L
18V
1.5Ah



STBL182L
18V
2.0A



STBL184L
18V
4.0Ah

CHARGER



SC121
10.8V
1.25A



SC201
18V
1.0A



METAL WORKING



Performed in faster material removal while grinding and better accuracy & comfort while cutting, the STANLEY® high performance metal working tools have been developed to combine excellent power to weight characteristics with outstanding ergonomics. They deliver the versatility, power and life that is demanded by a tradesman.

PERFORMANCE IN ACTION™

SMALL ANGLE GRINDER

STGS5100 100mm 580W Slide Switch Small Angle Grinder



- Features Compact Size And Slim Housing For Increased User Convenience In Light Applications
- Dust Seal Main Bearing & Armature Resin Coated Provide Maximum Motor Life & Durability
- Optimized Vent For Excellent Motor Cooling

* For Taiwan It's STGS6100 Rating Power Is 600W

SPECIFICATIONS

Power (Watts)	580
Wheel diameter (mm)	100
Spindle thread	M10
No load speed (RPM)	12000
Cord set length (m)	2.0
Wide (mm)	53
Length (mm)	255
Weight (kg)	1.55

STGT5100 100mm 580W Toggle Switch Small Angle Grinder



- Features Compact Size And Slim Housing For Increased User Convenience In Light Applications
- Dust Seal Main Bearing & Armature Resin Coated Provide Maximum Motor Life & Durability
- Optimized Vent For Excellent Motor Cooling

* For Taiwan It's STGT6100 Rating Power Is 600W

SPECIFICATIONS

Power (Watts)	580
Wheel diameter (mm)	100
Spindle thread	M10
No load speed (RPM)	12000
Cord set length (m)	2.0
Wide (mm)	53
Length (mm)	255
Weight (kg)	1.55

STGS6100 680W Small Angle Grinder



- Medium Power SAG (680W), Not Suggested For Stone Cutting
- Compact Housing Shape Design For Easy Grasp And Handle
- Spiral Bevel Gear Set Offers Less Vibration, Less Noise, Longer Life

SPECIFICATIONS

Power (Watts)	680 W
No Load Speed	11,000 rpm
Switch Type	Slide
Spindle Size	M10
Disc Size	100 mm
Cable Length	2.5 m
Net Weight	1.8 kg

STGS7100 100mm 710W Slide Switch Small Angle Grinder



- Medium Power SAG (710W), Not Suggested For Stone Cutting
- Compact Housing Shape Design For Easy Grasp And Handle
- Spiral Bevel Gear Set Offers Less Vibration, Less Noise, Longer Life

SPECIFICATIONS

Power (Watts)	710 W
No Load Speed	11,000 rpm
Switch Type	Slide
Spindle Size	M10
Disc Size	100 mm
Cable Length	2.5 m
Net Weight	1.8 kg

STGT7100 100mm 710W Toggle Switch Small Angle Grinder



- Medium Power SAG (710W), Not Suggested For Stone Cutting
- Compact Housing Shape Design For Easy Grasp And Handle
- Spiral Bevel Gear Set Offers Less Vibration, Less Noise, Longer Life

SPECIFICATIONS

Power (Watts)	710 W
No Load Speed	11,000 rpm
Toggle Type	Toggle
Spindle Size	M10
Disc Size	100 mm
Cable Length	2.5 m
Net Weight	1.8 kg

STGS8100 100mm 850W Slide Switch Small Angle Grinder



- 850W Powerful Motor With High Working Efficiency, Designed For Heavy Duty Job
- Ergonomic Design Provides Excellent Balance And Less Vibration
- Longest Durability In Its Class

SPECIFICATIONS

Power	850 W
No Load Speed	11,000 rpm
Switch Type	Slide
Spindle Size	M10
Disc Size	100 mm
Cable Length	2.5 m
Net Weight	2.2 kg

STGT8100 100mm 850W Toggle Switch Small Angle Grinder



- 850W Powerful Motor With High Working Efficiency, Designed For Heavy Duty Job
- Ergonomic Design Provides Excellent Balance And Less Vibration
- Longest Durability In Its Class

SPECIFICATIONS

Power	850 W
No Load Speed	11,000 rpm
Toggle Type	Toggle
Spindle Size	M10
Disc Size	100 mm
Cable Length	2.5 m
Net Weight	2.2 kg

LARGE ANGLE GRINDER

STGL2218 180mm 2200W Large Angle Grinder



- 2200W Powerful Motor Provides Excellent Performance & Durability
- High Quality Safety Switch With Lock-on Function
- Ergonomic Handle Design For A Good Handling And Less User Fatigue

SPECIFICATIONS

Input power	2200W
Disc Capacity	180 mm
No-load Speed	8500 rpm
Switch Type	Trigger
Lock On/Off	Yes
Cable Length	2mm
Weight	5.9kg

STGL2223 230mm 2200W Large Angle Grinder



- 2200W Powerful Motor Provides Excellent Performance & Durability
- High Quality Safety Switch With Lock-on Function
- Ergonomic Handle Design For A Good Handling And Less User Fatigue

SPECIFICATIONS

Input power	2200W
Disc Capacity	230 mm
No-load Speed	6500 rpm
Switch Type	Trigger
Lock On/Off	Yes
Cable Length	2mm
Weight	6.0kg

STGL2018 180mm 2000W Large Angle Grinder



- Powerful 2000W Motor Designed For Professional Applications
- Two Step Safety Switch Prevents Accidental Starts
- Multi-angle Rotation Gear Box Allows For Ideal Balance In Surface And Edge Grinding Applications

SPECIFICATIONS

Power	2000W
No Load Speed	8500 rpm
Switch Type	Trigger
Spindle Size	M14
Disc Size	180 mm
Cable Length	2mm
Weight	5.4kg

STGL2023 230mm 2000W Large Angle Grinder



- Powerful 2000W Motor Designed For Professional Applications
- Two Step Safety Switch Prevents Accidental Starts
- Multi-angle Rotation Gear Box Allows For Ideal Balance In Surface And Edge Grinding Applications

SPECIFICATIONS

Power	2000W
No Load Speed	8500 rpm
Switch Type	Trigger
Spindle Size	M14
Disc Size	180 mm
Cable Length	2mm
Weight	5.6kg

DIE GRINDER

STEL861 6mm 500W Die Grinder



- On/Off Toggle Switch Offers Longer Working Time
- Accessible Brush For Easy Replacement
- Full Rubber Protection On Front Housing For Increased Comfort

SPECIFICATIONS

Power	500W
No Load Speed	30000 rpm
Switch Type	Toggle
Spindle Size	M15
Collet Size	6 mm
Cable Length	3mm
Net Weight	2kg

CHOP SAW

STEL701 355mm 2100W Chop Saw



- High Torque 2100W Motor Provides High Performance And Long Durability
- Ergonomic Design For Good Handling And Less User Fatigue
- Heavy Duty Guard For Maximum User Protection

SPECIFICATIONS

Power	2,100W
No Load Speed	3,800 rpm
Max Wheel Size	355mm
Cable Length	2mm
Weight	15.5kg

Accessories - Abrasive Disc

STANLEY®

Phenolic resins of the highest quality which include active agents for: optimum blade life, clean and fast cuts without overheating.

More abrasive grains per blade, faster cutting action. Smoother cutting pace.

Diameter - Thickness /
Weight - Spindle size

Denser and less porous blades, more durable and rough for a longer shelf life.

Active grain structure, provides optimum grinding interaction between the blade and the workpiece.

Premium fiber glass meshes on each blade for greater strength and safety.



- STANLEY® laminated blades remove material quickly and leave a greater quality finish. This ability to remove material aggressively and leave a clean finish in only one step, is the main advantage over fiber blades.
- Premium grains for aggressive removal
- High-quality abrasive fiber for greater durability
- Fiberglass support for maximum use of the blade



STANLEY® ABRASIVES DISC PRODUCT RANGE

Catalog Number	Type	Application	Dia (mm)	Thickness	Bore	Grade	Max RPM	Unit Packs
STA8060	1	Cutting	105	1.2	16	Stainless Steel	15200	25
STA8050	1	Cutting	100	1.6	16	Stainless Steel	15200	25
STA4520FA	1	Cutting	100	2.5	16	Metal	15200	25
STA4520	27	Grinding/ Cutting	100	3	16	Metal	15200	25
STA4510	27	Grinding	100	4	16	Metal	13750	25
STA4500	27	Grinding	100	6	16	Metal	13750	25
STA4522FA	1	Cutting	125	2.5	22.2	Metal	12200	25
STA4522	27	Grinding/ Cutting	125	3	22.2	Metal	12200	25
STA4502A	27	Grinding	125	6	22.2	Metal	11000	25
STA4523FA	1	Cutting	150	2.5	22.2	Metal	10100	10
STA4523	27	Grinding/ Cutting	150	3	22.2	Metal	10100	10
STA4503A	27	Grinding	150	6	22.2	Metal	10100	10
STA4524FA	1	Cutting	180	2.5	22.2	Metal	8500	10
STA4524	27	Grinding/ Cutting	180	3	22.2	Metal	8500	10
STA0414	27	Grinding	180	6	22.2	Metal	8500	10
STA0415	27	Grinding	230	6	22.2	Metal	6600	10
STA8011R	1	Cutting	350	3	25.4	Metal	3875	10
STA8012R	1	Cutting	400	3	25.4	Metal	3440	10

PERFORMANCE IN ACTION™

PERFORMANCE CHART & APPLICATION USAGE

CUTTING

Stanley life better by 32% to 137%

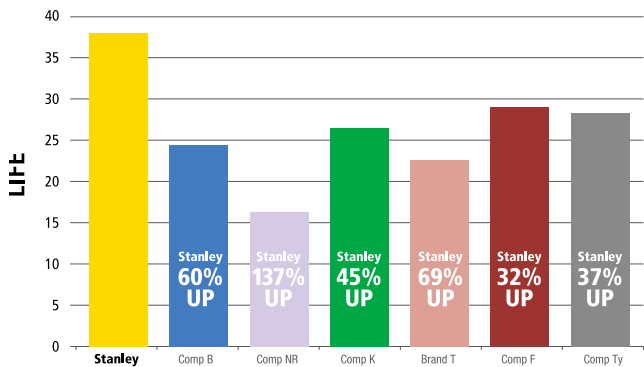

GRINDING

Stanley cut rate better by 13% to 34%

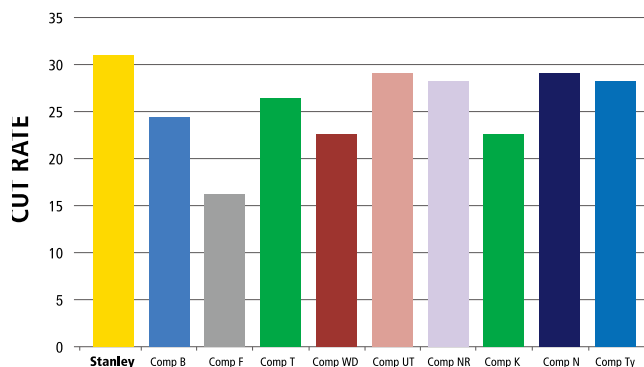

Know the key symbols

GRINDING

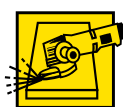

CUTTING



CONCRETE



Highly durable and best-in-class performance – Two traits of the STANLEY® Concrete range. While the full range of rotary hammers with the SDS-Plus chuck configuration provides excellent power to weight ratio, the demolition hammers with a choice between SDS-Max and Hex Chuck is designed to give comfort during long usages. The tile cutter comes also with a wet kit variant.

PERFORMANCE IN ACTION™

ROTARY HAMMER

STHR202K 2kg 20mm Hammer



- Unique Safety Feature To Prevent End User From Sudden Shock In Case Of Drill Bit Jam/ Re-Bar
- 620W Motor Optimum Drilling Speed From 5mm-10mm Diameters And Long Durability
- Compact Design For Increased Comfort And Control

SPECIFICATIONS	
Input Power (W)	620 W
Chuck Capacity	20 mm
Chuck Type	SDS+
No Load Speed	0-1,250 rpm
Blows/Min	0-3900 bpm
Drilling Mode	Hammer Drill& Rotary Drill
Lock-On Switch	Yes
Max Capacity Concrete/ Steel	20 mm / 13mm
Safety Clutch	Yes
Weight	2.6 kg

STEL501K 22mm 720W 1 Mode Hammer



- High Performance, 720w Motor For Serious Drilling Into Concrete And Masonry
- Powerful SDS Plus Hammer Drill With 0-5200 Impact Per Minute, Maximizing Drilling Speed
- Depth Guide To Assist The User When Pre-determined Depth Is Needed

SPECIFICATIONS	
Power	720W
Chuck Size	22mm
Mode	1
No Load Speed	0-980 rpm
Blows/Min	0-5,200 bpm
Lock-On Switch	Yes
Variable Speed	No
Max Capacity	
Concrete	22mm
Steel	13mm
Wood	30mm
Weight	3.0 kg

STEL503K 22mm 720W 3 Mode Hammer



- High Performance, 720w Motor For Serious Drilling Into Concrete And Masonry
- Depth Guide To Assist The User When Pre-determined Depth Is Needed
- 3 Mode - Hammer Drill, Drilling & Chiseling Modes For All Job-site Applications

SPECIFICATIONS	
Power	720W
Chuck Size	22mm
Mode	1
No Load Speed	0-980 rpm
Blows/Min	0-5,200 bpm
Lock-On Switch	Yes
Variable Speed	No
Max Capacity	
Concrete	22mm
Steel	13mm
Wood	30mm
Weight	3.0 kg

STEL505K 26mm 720W 2 Mode Hammer



- Powerful 750W 26mm Capacity Rotary Hammer
- 2 Mode, Hammer Drilling & Rotary Drilling For All Materials
- Greater Durability, Ergonomics & Drilling Performance

SPECIFICATIONS	
Power	720W
Chuck Size	26mm
Mode	2
No Load Speed	0-1050 rpm
Blows/Min	0-5,200 bpm
Lock-On Switch	Yes
Variable Speed	Yes
Max Capacity	
Concrete	26mm
Weight	2.7 kg

STEL506K 26mm 750W 3 Mode Hammer



- Powerful 750W 26mm Capacity Rotary Hammer
- 3 Mode - Hammer Drilling, Rotary Drilling & Chiseling Mode For All Job-site Applications
- Greater Durability, Ergonomics & Drilling Performance

SPECIFICATIONS	
Power	750W
Chuck Size	26mm
Mode	3
No Load Speed	0-1050 rpm
Blows/Min	0-5,200 bpm
Lock-On Switch	Yes
Variable Speed	Yes
Max Capacity	
Concrete	26mm
Weight	2.8 kg

STHR271K 26mm 850W 1 Mode L-Shape Hammer



- Powerful 850W Motor For High Drilling Speed
- 4.1J Of Impact Energy For High Impact Energy For 12-16mm Drilling & Good Chipping
- Safety Clutch Unique Safety Feature To Prevent End-User From Sudden Shock In Case Of Drill Bit Jam/Re-Bar

SPECIFICATIONS	
Power	850W
Chuck Size	26mm
Mode	1
No Load Speed	700 rpm
Blows/Min	3,400 bpm
Impact Energy	4.1 J
Variable Speed	No
Max Capacity	
Concrete	26mm
Safety Clutch	Yes
Weight	5.1 kg

STHR272K 26mm 850W 5kg L-Shape Hammer



- Powerful 850W Motor For High Drilling Speed
- 4.1J Of Impact Energy For High Impact Energy For 12-16mm Drilling & Good Chipping
- Safety Clutch Unique Safety Feature To Prevent End-User From Sudden Shock In Case Of Drill Bit Jam/Re-Bar

SPECIFICATIONS	
Power	850W
Chuck Size	26mm
Mode	2
No Load Speed	700 rpm
Blows/Min	3,400 bpm
Impact Energy	4.1 J
Variable Speed	No
Max Capacity	
Concrete	26mm
Safety Clutch	Yes
Weight	5.1 kg

CHIPPING HAMMER

STHM5KH 1010W 17mm Hex Chipping Hammer



- 1010W Powerful Motor Delivers Outstanding Chipping And Chiseling Performance
- Anti-Vibration System For Low Vibration And More Comfort
- Rubber Coated Back Handle Design For Improved Comfort In Use

SPECIFICATIONS	
Power	1010W
Chuck Capacity	17mm HEX
Impact Rate	2900 BPM
Lock-On Switch	Yes
Anti Vibration Handle	Yes
Cordset Length	3.5m
Weight	6.1Kg

STHM10K SDS Max 10Kg Demolition Hammer



- Powerful 1600W Motor For Light-Heavy Duty Demolition, Chipping & Chiseling Applications
- SDS Max Chuck For Easy Accessory Availability
- Rubber Grip For Comfortable Long Duration Usage

SPECIFICATIONS

Input Power (W)	1600W
Chuck Type	SDS Max
Handle Grip Type	Rubber
Switch Type	Trigger ON/OFF
Lock-On Switch	Yes
BPM	900-1890
Chisel positions	12
Weight	10.5Kg

TILE CUTTER

STSP125 High Power Tile Cutter



- Powerful 1320W Motor For Highest Working Efficiency
- Optimized 13000 RPM For High Cutting Efficiency
- 125mm Capacity Guard For All Job-site Applications
- Optimized Gear Set For Less Vibration, Lower Noise & Longer Life Span

SPECIFICATIONS

Power	1320 W
Wheel Diameter	125 mm
No-Load Speed	13000 BPM
Max. Depth Of Cut	41 mm
Weight	3.1 kg
Cable Length	2.5 m



Accessories - Diamond Blades



Turbo	
Characteristics	
<ul style="list-style-type: none"> Advanced diamond belt system Made with industrial diamond 	
Benefits	
<ul style="list-style-type: none"> Long life Optimum cutting performance Fast material removal Provide good finish Can be used wet or dry 	

Segmented	
Characteristics	
<ul style="list-style-type: none"> Laser welded segments Optimized cutting belt High-quality steel body 	
Benefits	
<ul style="list-style-type: none"> More durable than sintered blades Optimum cutting performance Quick cuts Greater durability Reduces distortion and vibration at high temperatures 	

Continuous	
Characteristics	
<ul style="list-style-type: none"> Optimized cutting belt High-quality steel plate To be used wet or dry 	
Benefits	
<ul style="list-style-type: none"> Precise cuts Greater durability Balance when cutting Does not break material 	

SKU Number	Description	Type	BAR CODES	
			UNIT	Master Pack
STA47400L	4" (105mm) x 0.080 x 7mm x 20mm	Turbo	7896525088585	17896525088582
STA47401L	4" (105mm) x 0.080 x 5mm x 20mm	Continuous	7896525088592	17896525088599
STA47402L	4" (105mm) x 0.080 x 7mm x 20mm	Segmented	7896525088608	17896525088605
STA47400B	4" (105mm) x 0.080 x 7mm x 20mm arbor	Turbo	7896525088615	17896525088612
STA47401B	4" (105mm) x 0.080 x 5mm x 20mm arbor	Continuous	7896525088622	17896525088629
STA47402B	4" (105mm) x 0.080 x 7mm x 20mm arbor	Segmented	7896525088639	17896525088636
STA47450L	4-1/2" (115mm) x 0.080 x 7mm x 20mm	Turbo	7896525088646	17896525088643
STA47451L	4-1/2" 115mm x 0.080 x 5mm	Continuous	7896525088653	17896525088650
STA47452L	4-1/2" 115mm x 0.080 x 7mm	Segmented	7896525088660	17896525088667
STA47700L	7" (180mm) x 0.080 x 7mm x 20mm	Turbo	7896525088677	17896525088674
STA47701L	7" (180mm) x 0.080 x 7mm x 20mm	Continuous	7896525088684	17896525088681
STA47702L	7" (180mm) x 0.080 x 7mm x 20mm	Segmented	7896525088691	17896525088698
STA47900L	9" (230mm) x 0.095 x 5mm x 20mm	Turbo	7896525088707	17896525088704
STA47901L	9" (230mm) x 0.095 x 5mm x 20mm	Continuous	7896525088714	17896525088711
STA47902L	9" (230mm) x 0.095 x 5mm x 20mm	Segmented	7896525088721	17896525088728
STA47122L	12" x .125 x 10mm x 1 x 20mm	Laser Welded	7896525088738	17896525088735
STA47142L	14" x .125 x 10mm x 1 x 20mm	Laser Welded	7896525088745	17896525088742

SDS PLUS CARBIDE DRILL BITS

STANLEY

Power Tool Accessories

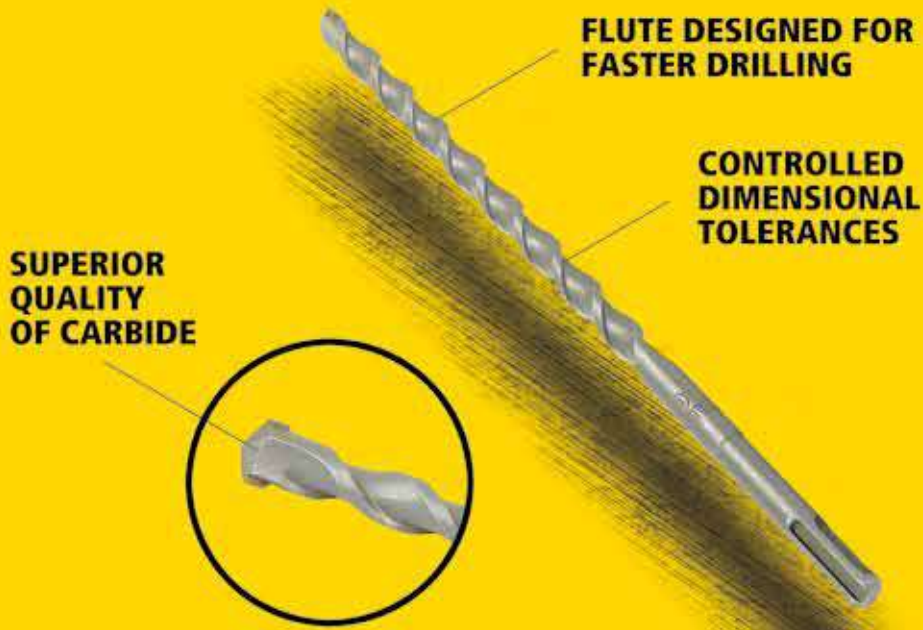

WIN WITH STANLEY

- Superior performance on hard concrete and bricks
- Longer life: 4.5% to 16% longer than competition
- Consistent quality

APPLICATIONS



STANLEY® SDS PLUS CARBIDE DRILL BITS LAST LONGER BY 4.5% TO 16%

PERFORMANCE CHART*

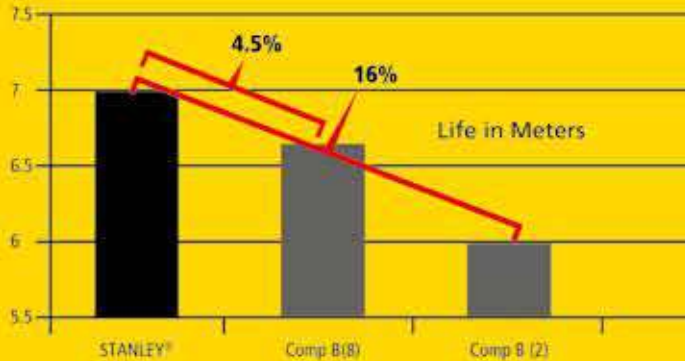

*Performance of Carbide Drill Bits was evaluated with an automated test rig on hard concrete and standard drilling conditions.

SDS PLUS, SDS MAX AND HEX CHISELS

STANLEY

Power Tool Accessories

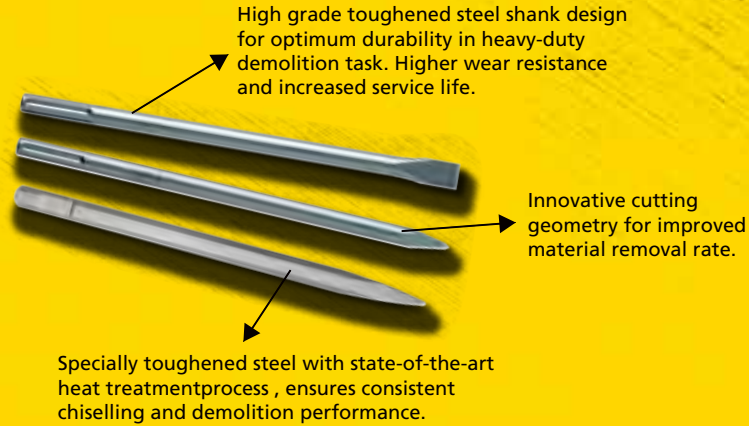

Shank Fitment



APPLICATIONS



WIN WITH STANLEY

- Heavy-duty chiseling
- Restoration of joints in Masonry and Concrete
- Demolition work in Concrete, Stone Floor and Wall Tiles

SKU No.	Description	Shank	Shape	Size	Pack Style
STA54401	SDS PLUS ROUND BODY POINT CHISEL	SDS+	Point	14x250	Tube
STA54406	SDS PLUS ROUND BODY FLAT CHISEL	SDS+	Flat 20 mm	14x250x20	Tube
STA54411	SDS PLUS ROUND BODY FLAT CHISEL	SDS+	Flat 40 mm	14x250x40	PVC Pouch
STA54416	SDS MAX ROUND BODY PONT CHISEL	SDS MAX	Point	18x300	Tube
STA54421	SDS MAX ROUND BODY PONT CHISEL	SDS MAX	Point	18x400	Tube
STA54426	SDS MAX ROUND BODY FLAT CHISEL	SDS MAX	Flat 25 mm	18x300x25	Tube
STA54431	SDS MAX ROUND BODY FLAT CHISEL	SDS MAX	Flat 25 mm	18x400x25	Tube
STA54436	SDS MAX ROUND BODY FLAT CHISEL	SDS MAX	Flat 50 mm	18x400x50	PVC Pouch
STA54441	19x400 Hex Shank Chisel	HEX	Point	19x400	Tube
STA54446	19x600 Hex Shank Chisel	HEX	Point	19x600	Tube
STA54451	19x400x25 Hex Shank Chisel	HEX	Flat 25 mm	19x400x25	Tube
STA54456	19x600x25 Hex Shank Chisel	HEX	Flat 25 mm	19x600x25	Tube
STA54466	19x300mm Hex Shank Chisel	HEX	Point	19x300	Tube
STA54476	17x280x22mm Hex Shank Chisel	HEX	Flat 22 mm	17x280x22	Tube
STA54481	17x450x22mm Hex Shank Chisel	HEX	Flat 22 mm	17x450x22	Tube
STA54496	17X450mm Hex Shank Chisel	HEX	Point	17x450	Tube
STA54501	17x280mm Hex Shank Chisel	HEX	Point	17x280	Tube

SDS+ Hammer Masonry Drill bit

SKU	DESCRIPTION	Qty Per Pack	Master pack qty
STA54002	SDS Hammer Ø5mm x 110mm	1	200
STA54012	SDS Hammer Ø6mm x 110mm	1	200
STA54022	SDS Hammer Ø8mm x 110mm	1	200
STA54027	SDS Hammer Ø10mm x 110mm	1	200
STA54032	SDS Hammer Ø6mm x 160mm	1	200
STA54037	SDS Hammer Ø8mm x 160mm	1	200
STA54042	SDS Hammer Ø10mm x 160mm	1	200
STA54047	SDS Hammer Ø12mm x 160mm	1	200
STA54052	SDS Hammer Ø14mm x 160mm	1	100
STA54057	SDS Hammer Ø8mm x 210mm	1	100
STA54062	SDS Hammer Ø10mm x 210mm	1	100
STA54067	SDS Hammer Ø12.0mm x 210mm	1	100
STA54072	SDS Hammer Ø14.0mm x 210mm	1	100
STA54077	SDS Hammer Ø16mm x 210mm	1	100
STA54087	SDS Hammer Ø20mm x 210mm	1	50
STA54097	SDS Hammer Ø12.0mm x 260mm	1	100
STA54102	SDS Hammer Ø14mm x 310mm	1	100
STA54107	SDS Hammer Ø16mm x 310mm	1	50
STA54112	SDS Hammer Ø18mm x 310mm	1	40
STA54117	SDS Hammer Ø20mm x 310mm	1	40
STA54122	SDS Hammer Ø12mm x 450mm	1	100
STA54127	SDS Hammer Ø16mm x 450mm	1	50
STA54132	SDS Hammer Ø18mm x 450mm	1	20
STA54137	SDS Hammer Ø20mm x 450mm	1	20
STA54152	SDS Hammer Ø7mm x 160mm	1	200
STA54227	SDS Hammer Ø25.0mm x 450mm	1	20
STA54237	SDS Hammer Ø4mm x 110mm	1	200
STA54282	SDS Hammer Ø5mm x 160mm	1	200



CONSTRUCTION SAW & WOOD WORKING



Cutting through a variety of materials, the STANLEY® Saw range takes on the strain of cutting and sawing with ease. The range is designed to provide a powerful, precise and comfortable experience to the user.

STANLEY® woodworking range also caters to routing, planing and sanding. While durability is a given in any STANLEY® tools, the router boasts of controlled power, Planers with high depth of cut & safety and Sanders providing smooth results every time, all the time.

PERFORMANCE IN ACTION™

SAW

STEL311 1510W 185mm Circular Saw



- 36 Teeth Carbide Blade For Fast Smooth Cutting
- Beveling Shoe For Angled Cuts
- Cutting Depth Adjusted Up To 62mm At 90 Degree

SPECIFICATIONS

Power	1,510W
No-Load Speed	5,500 rpm
Max. Blade Diameter	185 mm
Max. Cutting Depth	62 mm
Max. Bevel	45 degree
Weight	3.9 kg

STEL345 650W Jig Saw



- Provides Multiple Speed Settings For Optimal Cutting Results
- At 0°, 15°, 30° And 45°
- Makes Bevel Changes Fast And Easy
- Makes Blade Replacements Fast And Easy
- Provides Greater Visibility On The Cutting Surface

SPECIFICATIONS

Power	650 W
Strokes/Min	800-3,200 SPM
Stroke Length	20 mm
Weight	2.7 kg

STEL365 900W Reciprocating Saw



- Easy Twist Tool-free Blade Change
- Tooled Shoe Adjustment
- Variable Speed Trigger

SPECIFICATIONS

Power	900 W
Strokes/Min	0-3,200 SPM
Stroke Length	148 mm
Weight	3.2 kg

STEL721 1500W 254mm Mitre Saw



- 80 Carbide Teeth Saw Blades For Fast Cutting In
- Wood And Fine Finishing
- 9 Pre-Index Miter Stops For Quick & Accurate Cuts
- Auto Retracting Blade Guard For Maximum Safety And Comfort

SPECIFICATIONS

Power	1,500 W
No-Load Speed	5,500 rpm
Max. Blade Diameter	254mm
Max. Diameter	140x70 mm
Weight	12.5 kg

Accessories - Saw Blades

Top-quality carbide durability
with higher performance than steel

Carbide bits
that are tougher and more durable
compared to steel

**Tempered for
a longer
shelf life**

Fine setting design
for more efficient cuts

Fine setting design
for more efficient cuts

Expansion slots
which prevent deformations

Catalog Number	Description	Diameter	No. of Teeth	Unit UPC	Master Pack Qty.	Master Pack UPC
STA7717	Quick wood cuts - Carbide teeth	7-1/4"	18	7896525088844	3	17896525088841
STA7737	Cross and longitudinal wood cuts - Carbide teeth	7-1/4"	24	7896525088851	3	17896525088858
STA7747	General wood cuts - Ground steel blade	7-1/4"	140	7896525088868	3	17896525088865
STA7757	Fine wood cuts - Carbide teeth	7-1/4"	40	7896525088875	3	17896525088872
STA7740	Quick cutting blade - Carbide teeth	10"	60	7896525088882	3	17896525088889
STA7770	Fine cutting blade - Carbide teeth	10"	32	7896525088899	3	17896525088896

WOODWORKING

SSS310 1/2 Sheet Sander



- Orbital sander suitable for all general sanding applications
- Thumb lever clamping system holds paper fast whilst sanding
- Dust extraction bag for a cleaner working environment
- Ergonomic front handle for comfortable operation
- Surface finishing of large flat areas e.g. doors and tables
- Removal of paint, varnish, and other surface coatings

SPECIFICATIONS

Power	310 W
No load speed	6000-10.000 rpm
Eccentricity	1.0 mm
Orbit diameter	2.0 mm
Paper size	115 x 280 mm
Platten size	115 x 230 mm
Paper attachment	Thumb level clamping system

STEL630 750W Planer



- 750W Powerful Motor
- Substantial Depth Of Cut Without Compromising The Finish
- 12mm Rabbeting Depth With 0.2mm Accuracy

SPECIFICATIONS

Power	770 W
No-Load Speed	16,500 rpm
Planing Width	82mm
Planing depth	1.6 mm
Rebating depth	12 kg
Weight	2.7 kg

STEL670 2000W Heatgun



- Spherical Nozzle
- Two Air Flow Stages, Variable Temperature Settings To Meet Different Use Requirements
- Designed For Free-Standing Base

SPECIFICATIONS

Power	2,000 W
Heat Setting	Variable
Switch Control	2 Stages
Temperature	50 - 450°C / 90 - 600°C
Air Flow	300/500 lpm
Cable length	3 m

STEL680 600W Blower



- 600W Powerful Motor For Higher Tool Performance
- Variable Speed Control To Achieve Different Applications
- 2 Tools In 1: Blower And Vacuum Cleaner

SPECIFICATIONS

Power	600 W
No Load Speed	0 - 16,000 rpm
Air Volume	3.5 m ³ /min
Cable length	3 m
Weight	1.7 kg

STST1825 1800W Table Saw



- Powerful 1800W Motor For High Performance
- Self Aligning Rip Fence And Ease Of Control
- With Wheels For Easy Transportation

SPECIFICATIONS

Power	1800W
No Load Speed	4800 rpm
Blade Size	254mm
Max Cutting Capacity	
At 45°	56mm
At 90°	76mm
Blade Bevel Range	0-45°
Weight	30.55kg

OUTDOOR

STPW1800 1800W Pressure Washer



- Hose Reel For The Best Storage And Carrying Solution
- Durable And Powerful Motor & Pump
- Auto Stop System

SPECIFICATIONS

Power	1800W
Max. Pressure	140bar
Working Pressure	100bar
Max. Water Flow	7.2l/min.
Max. Water Temperature	40°C
Hose Length	5m
Cable length	5m
Net Weight	9.7kg



HAND TOOLS & STORAGE

CONTENT

	LASER MEASUREMENT	42		TRANSMODULE SYSTEM	214
	MEASURING TOOLS	60		WRENCHES	220
	LAYOUT TOOLS	72		SOCKETS, WRENCHES, MECHANIC TOOL SETS	236
	STORAGE SOLUTIONS	84		IMPACT SOCKETS	288
	CUTTING TOOLS	108		TORQUE WRENCHES	306
	CLAMPING TOOLS	132		AIR TOOLS	318
	FASTENING TOOLS	156		SPECIALITY TOOLS&ACC	328
	STRIKING TOOLS	190		PRODUCTS INDEX	334
	FINISHING TOOLS	204		DISPLAY SELECTION	348

STANLEY®

LASER MEASUREMENT



Rotary Laser Levels

Point Laser Levels

Cross & Multi Line Laser Levels

Optical Laser Levels

True Laser Measures

Measuring Wheels

Stud Sensors

Moisture Detectors

Laser Pole, Glasses & Tripods



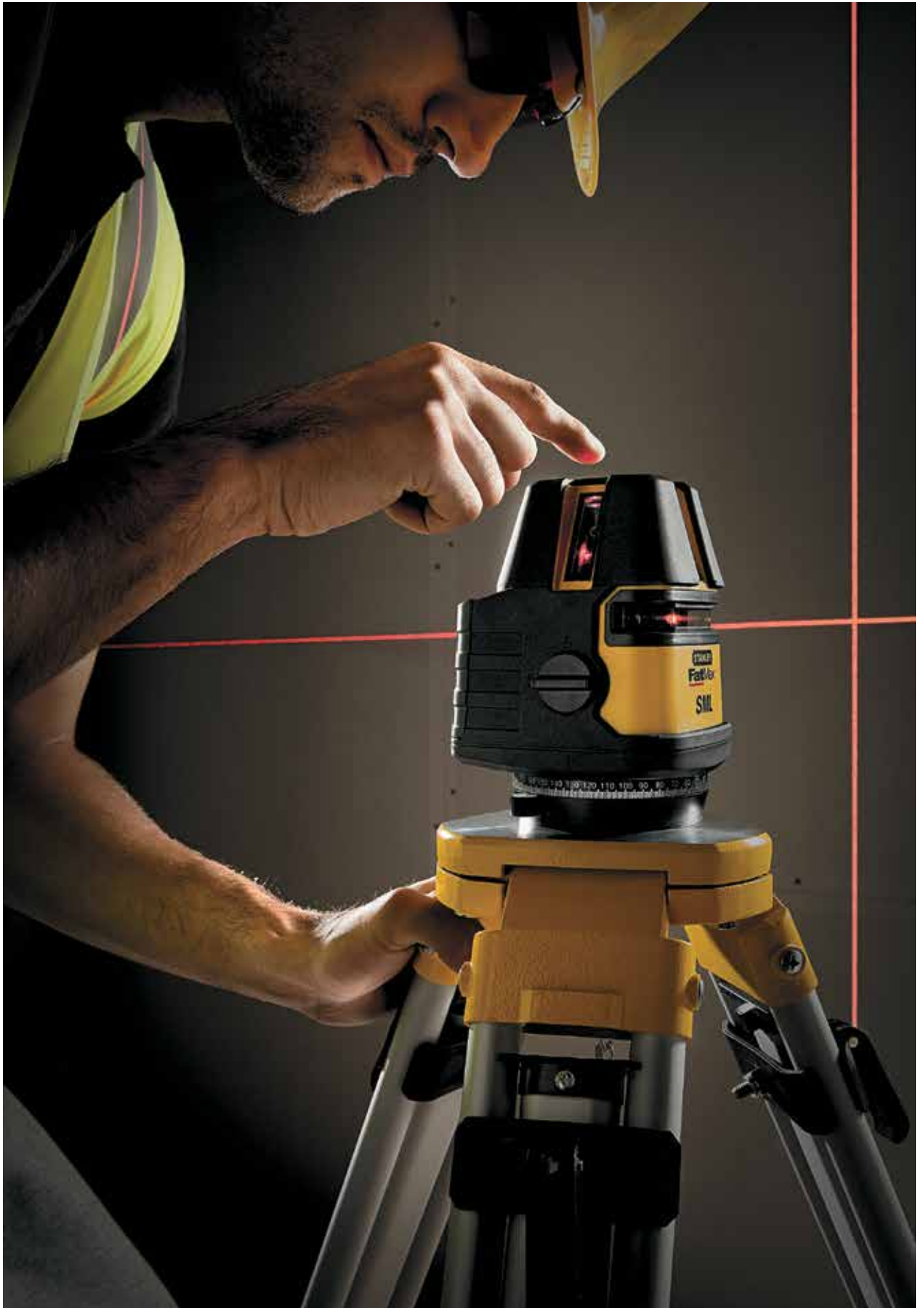

TECHNOLOGY THAT LIVES THROUGH THE AGES

The power of creation has never been as pronounced as the **STANLEY®** range of electronics. Lasers and flashlights are but the tip of the iceberg on how far applied science has helped push **STANLEY®** to the head of the pack.



THE 4 MAIN FUNCTIONS OF LASER TOOLS

LASER

STANLEY® products are designed and engineered by top minds around the world. No matter what you need, you will find **STANLEY®** laser products ranging from live wire detection, stub detection, distance measurement, and laser line marking.



Angles and slopes

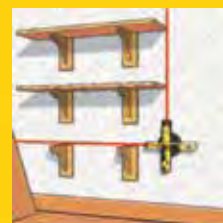

Squaring



Plumb line-take a point from floor to ceiling

















Horizontal & Vertical Levelling & Alignment

LASER APPLICATION GUIDE

- ★ Functional
- Ideal
- Not applicable



SITE LAYOUT

CATEGORY	PRODUCT DESCRIPTION	SITE LAYOUT		
		Levelling Foundation Form Work	Surface Levelling Drainage Gradings	Levelling Roads/Paths Driveways Landscaping
Optical Level	1-77-160  AL24 GVP Levelling Set	★	★	★
	1-77-245  AL 32	★	★	★
Rotary Laser	FMHT1-77441  FatMax® HVPW-G Rotation Laser, Green	●	●	●
	1-77-429  FatMax® rotary Laser RL HW+	★	★	★
Cross & Multiline Laser	1-77-320  Fatmax® Beam Self-Levelling Cross Line Laser (SCL)	●	■	●
	1-77-321  SCL-D Self-Leveling Cross Laser	★	■	★
	STHT1-77340  Cubix Cross Line Laser	★	■	★
	STHT1-77137  Stanley SLL360 Line Laser 360° with Cross	★	■	●
	STHT1-77341  Cross90™ Cross Line Laser	★	■	★
Point Laser	1-77319  SLP5 Self-Leveling 5-Point Laser Level	★	■	★
Laser Distance Measurer	STHT1-77032  TLM65 Laser Distance Measurer (20m)	■	■	■
	STHT1-77138  TLM99 Laser Distance Measurer	■	■	■
	STHT1-77343  TLM99S Laser Distance Measurer Bluetooth	■	■	■
	STHT1-77139  TLM165 Laser Distance Measurer	■	■	■
	STHT1-77140  TLM330 Laser Distance Measurer	■	■	■



FIRST FIX



SECOND FIX



FINISHING

FIRST FIX			SECOND FIX			FINISHING		
Squaring up Walls Doors & Windows	Structural Steelwork Scaffolding	Plumbing Installation Electrical Installation	Installing Suspended Ceilings, Overhead Lighting	Multipoint Alignment, Tracks & Plumb Lighting, Partitions	Electrical Layout, Trunking & Pipework	Tiling Panelling, Wallpapering	Kitchen Installation, Bathroom Installations	Shelving/ Cabinets, Borders & Dado Rails, Interior Decorating
	●							
	●							
★	★	★	★	★	★	★	★	●
★	★	●	★	★	★	●	★	●
★	●	●	●	★	★	★	★	★
●	●	●	●	★	★	★	★	★
★				★	★	★	★	★
★	●	●	●	★	★	★	★	★
★		●	●	★	★	★	★	★
●	●	●	●	★	★	★	★	★
						★	★	★
●	●	●	★	★	★	★	★	★
						★	★	★
●	●	●	★	★	★	★	★	★
●	●	●	★	★	★	★	★	★

OPTICAL LEVEL AL24



- Easy-to-read horizontal circle
- Penta Prism - Makes it easier to view the bubble
- Water resistant, sealed construction - Can be used in all weathers
- Sealed, dust-protected leveling screws
- Fine adjustment knobs on left and right sides with friction-braked rotation
- 5/8" x 11 threads to fit standard tripods
- Large effective aperture and minimum focus of 0.3 m
- Top optical peep sight for ease of ranging
- Magnetically dampened, wire hung compensator for optimum accuracy and range
- 1:100 stadia for estimating distance
- Large easy-to-use, precise focussing knob - Ease of use
- Compensator lock protects unit in transit



SKU #	Description	Leveling Type	Accuracy (line/rotary)	Working Range	IP Rating
1-77-160	AL24 GVP Levelling Set	Manual	1.6mm @45m	90 m	IP54

AL32 FATMAX® AUTOMATIC OPTICAL LEVEL 32X ZOOM



- 32x automatic optical level for larger site setting out and levelling
- Precision optics ensure accurate measurement over long distances
- Large easy to use focusing knob
- 1:100 stadia for estimating distance
- Sealed, dust & water protected for working in all conditions (IP54)



SKU #	Description	Leveling Type	Accuracy (line/rotary)	Working Range	IP Rating
1-77-245	AL32 FatMax® Automatic Optical Level 32x Zoom	Manual	1.6mm @75m	1m - 107m	IP54

FATMAX HVPW-G ROTATION LASER, GREEN

STANLEY
FATMAX



- Horizontal or vertical laser line
- Lot up (green) and down (red)
- 10% manual tilt
- 1/4 " and 5/8" thread for Befstigung on a tripod
- Anti-drift system

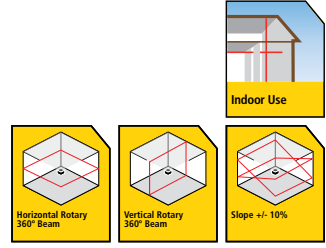
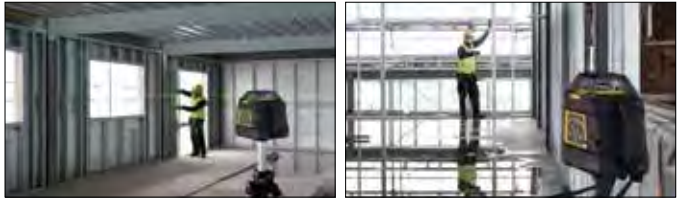

SKU #	Description	Leveling Type	Accuracy (line/rotary)	Working Range	IP Rating
FMHT1-77441	FatMax® HVPW-G Rotation laser, Green	Rotation/Point	1.5mm @30m (Horizontal) 3mm @30m (Vertical)	??	IP66

RL HW+ FATMAX® OUTDOOR ROTATING LASER

STANLEY
FATMAX



- Built for site conditions, the RL HW+ provides clear and accurate leveling for groundworks including gradients of up to 10%
- Drop proof glass enclosed beacon
- Working range 600m
- Rotating head can be set up for a 10% slope (manual grade)
- Glass enclosed head, rated to IP66

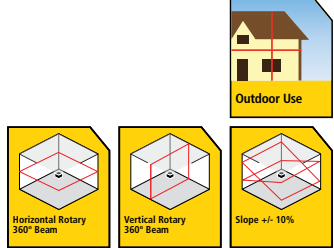

SKU #	Description	Leveling Type	Accuracy (line/rotary)	Working Range	IP Rating
1-77-429	RL HW + FatMax® Outdoor Rotating Laser	Auto (H/V)	1.5mm @30m (Horizontal) 3mm @30m (Vertical)	60 / 600m	IP66

SCL BEAM SELF-LEVELLING CROSS LINE LASER



- Working range: 10m
- Working environment: Interior use
- Magnetically dampened pendulum
- Projects 1 horizontal and 1 vertical line to create a cross line
- Pulsed beam mode allows operation outdoors in combination with the detector (supplied)
- Out of true level sensor
- Runs on 3 x A4 batteries (Supplied)
- Pendulum lock for safe transportation

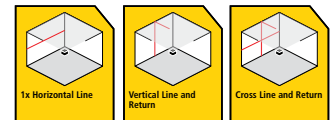
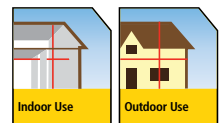

SKU #	Description	Leveling Type	Accuracy (line/rotary)	Working Range	IP Rating
1-77-320	FatMax® Beam Self-Levelling Cross Line Laser (SCL)	Self	0.2mm @1m	25m	IP54

SCL-D BEAM SELF-LEVELLING CROSS LINE LASER WITH PLUMB



- 2 beams allow for horizontal, vertical or crossbeam alignment
- Pulsed beam mode allows operation outdoors in combination with the detector (supplied)
- 30 metre range (spot laser) / 50 metre range (line laser) with detector supplied
- Projects 1 horizontal and 1 vertical line to create a cross line
- Magnetically dampened pendulum with lock for safe transportation

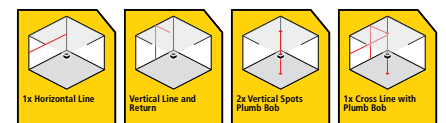
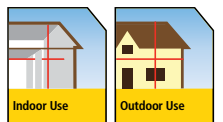
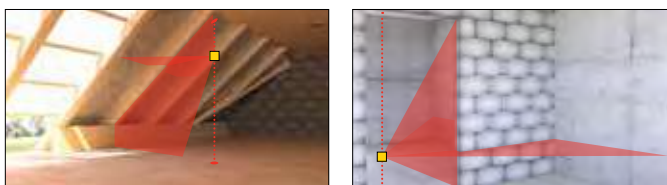

SKU #	Description	Leveling Type	Accuracy (line/rotary)	Working Range	IP Rating
1-77-321	SCL-D Beam Self-Levelling Cross Line Laser with Plumb	line/dot	0.2mm @1m	15m / 30m	IP54

CUBIX™ CROSS LINE LASER



- Self Leveling Cross Lines: Projects bright horizontal & vertical lines onto flat surfaces for common leveling and alignment applications
- QuickLink™ Bracket and Mounting System: Versatile bracket links into multiple product mounting slots and 1/4" thread Clamps on to multiple surfaces
- Range 40' / Accuracy +/-5/16": Performance supports common DIY and tradesman applications
- Locking Pendulum: For setting angled lines, To help prevent damage to internal components
- Compact, Lightweight Design

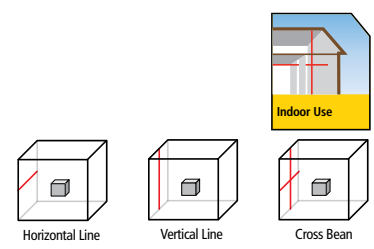

SKU #	Description	Type (dot/line/rotary)	Leveling Type	Accuracy (line/rotary)	Working Range with detector	IP Rating
STHT1-77340	Cubix™ Cross Line Laser	Line	Self	± 0.8mm@1m	8m	IP50

STANLEY® SLL360 LINE LASER 360° WITH CROSS



- Automatic self leveling
- Simple push button operation - Very easy to operate
- Laser line at 360° + 1 vertical line allows a cross line on front of the unit
- No pulse diode
- Projects 360° degree self leveling line - Gives an uninterrupted line just like a rotating laser
- Specific Wall Mount bracket for fine adjustments and can fit pole on
- Pendulum lock for safe transportation

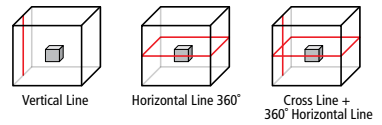

SKU #	Description	Type (dot/line/rotary)	Leveling Type	Accuracy (line/rotary)	Working Range with detector	IP Rating
STHT1-77137	Stanley® SLL360 Line Laser 360° with Cross	Line	Self	0.4mm @1m	10m (w/o dectector)	IP54

SLP5 POINT LASERS



- Projects 5 beams: 3 horizontal, 1 vertical and 1 plumb line
- 30m spot/ 10m line working range
- Multiple spots allow accurate setting of partitions, pipe runs and point to point layouts
- Self levelling design with 'out of true' level sensor
- Special magnetic base for attaching to rails with pivoting mount

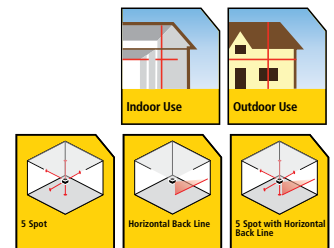

SKU #	Description	Leveling Type	Accuracy (line/rotary)	Working Range	IP Rating
1-77-319	SLP5 Point Lasers	Self	3mm @15m (H) 3mm @15m (U) 6mm @15m (D)	10m / 30m	IP54

3-BEAM SELF-LEVELLING CROSS LINE LASER



- Self Leveling Cross Lines: Projects bright horizontal & vertical lines onto flat surfaces for common leveling and alignment applications
- 90° Vertical Line: For an additional reference point for multiple applications
- QuickLink™ Bracket and Mounting System: Versatile bracket links into multiple product mounting slots and 1/4" thread, Clamps on to multiple surfaces
- Range 50' / Accuracy +/- 3/16": Performance supports common DIY and tradesman applications
- Locking Pendulum: For setting angled lines: To help prevent damage to internal components
- Over-molded Grips: For comfort & control

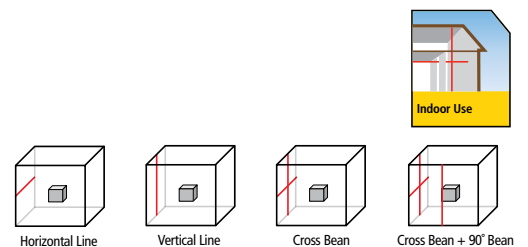
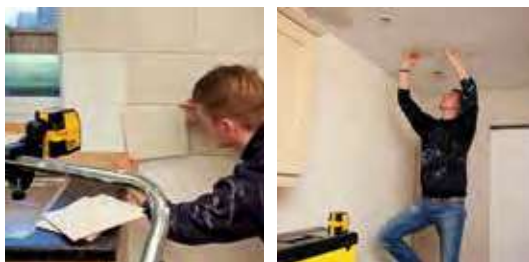

SKU #	Description	Type (dot/line/rotary)	Leveling Type	Accuracy (line/rotary)	Working Range with detector	IP Rating
STHT1-77341	Cross90™ Cross Line Laser	Line	Self	± 0.5mm@1m	10m	IP50

TLM65 LASER DISTANCE MEASURER

NEW
 2.5x faster than a tape measure
 100% accuracy
 100% accuracy
 100% accuracy



- Range 65' (20m)
- Accuracy +/- 1/8"
- Simple 2-button design for intuitive point and click measuring
- Measures distance, calculates area and volume
- Automatic calculations make job estimates quick and easy
- Instantly calculates square footage of a room or space
- Continuous measurement to help find target distance quickly and easily

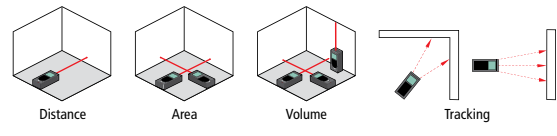
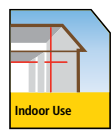

SKU #	Description	Leveling Type	Accuracy (line/rotary)	Working Range	IP Rating
STHT1-77032	TLM65 Laser Distance Measurer	Dot	± 3.0mm	0.21m - 20m	IP40

TLM99 LASER DISTANCE MEASURE

NEW
 2.5x faster than a tape measure
 100% accuracy
 100% accuracy
 100% accuracy



- Accuracy +/- 3/32" (2mm)
- Measures distance, calculates area & volume
- Automatic calculations make job estimates quick & easy
- Continuous measurement tracking function finds distance from a target quickly & easily
- Addition/subtraction convenient way to calculate in the field without a calculator or manual math

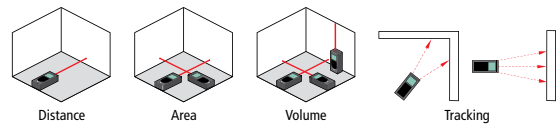
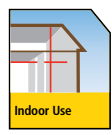

SKU #	Description	Leveling Type	Accuracy (line/rotary)	Working Range	IP Rating
STHT1-77138	TLM99 Laser Distance Measurer	Dot	± 2.0mm	0.1m - 30m	IP40

TLM 99S TRUE LASER MEASURE BLUETOOTH (30M)



- Range of up to 30m and accuracy of +/- 2mm
- The perfect DIY companion for home remodeling projects

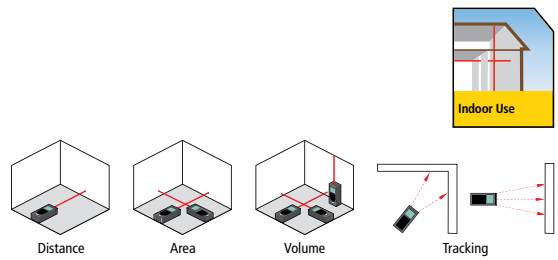

SKU #	Description	Leveling Type	Accuracy (dot)	Working Range	IP Rating
STHT1-77343	TLM 99S TRUE LASER MEASURE BLUETOOTH (30M)	dot	± 2.0mm	0.1m - 30m	IP40

TLM165 LASER DISTANCE MEASURE



- Increased 50m range
- Toe end piece for accurate positioning
- Backlit 2 line display
- 5 memory storage function
- Addition / subtraction calculator
- Includes storage pouch

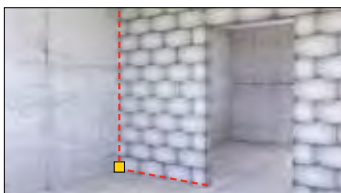

SKU #	Description	Type (dot/line/rotary)	Accuracy (dot)	Working Range	IP Rating	Display Backlight
STHT1-77139	TLM165 Laser Distance Measurer	Dot	± 1.5mm	0.1m - 50m	IP54	Yes

TLM330 TRUE LASER MEASURE (100M)



- Professional model for advanced measuring
- 100m range and inclination sensor for indirect distance and height measurement
- Backlit 3 line display for better visibility
- 20 memory storage function
- Toe end piece for accurate positioning



Digital Levelling Measurement

IP54

Backlit LCD Display

Audio Alert

Folding Toe

Indoor Use

Outdoor Use

SKU #	Description	Leveling Type	Accuracy (line/rotary)	Working Range	IP Rating
STHT1-77140	TLM 330 TRUE LASER MEASURER (100M)	Dot	± 1.0mm	0.05m - 100m	IP54

MW40M COUNTER MEASURING WHEEL

Pro rating out of 5



- Durable traditional counter measuring wheel with heavy duty metal folding handle
- Die cast aluminum wheel with wear resistant rubber tread for improved traction & longer life
- Folding wheel mount and kick stand
- 5 digit counter with manual reset button for superb accuracy
- Rubber hand grip for maximum durability
- Gear driven counter with tough plastic housing

Indoor Use

Outdoor Use

SKU #	Description	Range	Wheel Diameter	Wheel type	UOM	Accuracy
1-77-174	MW40M Counter Measuring Wheel	9999.99m	318mm	spoke	m/cm	+/- 1% typically

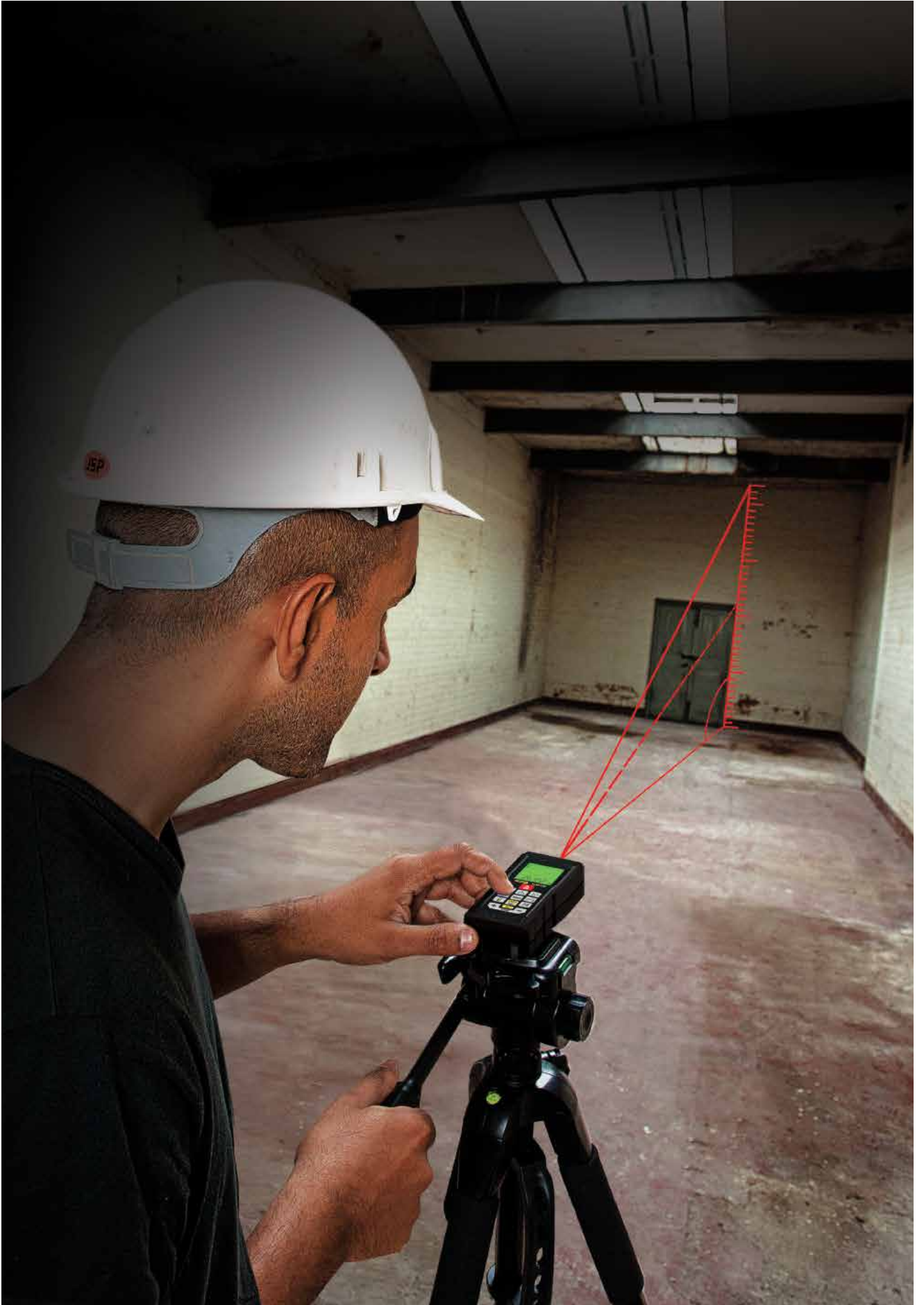

STUD FINDER



- The S300 is the pro's choice for stud detection. This fully featured model includes a backlit LCD for easy reading in low light conditions and can detect stud centres up to 38mm depth.
- Including AC live wire detection up to 51mm, it also includes a scan mode for precise detection up to 75mm for ferrous metals and 38mm for copper - ideal for pipework detection.
- Detects wood/metal stud centres up to 38mm

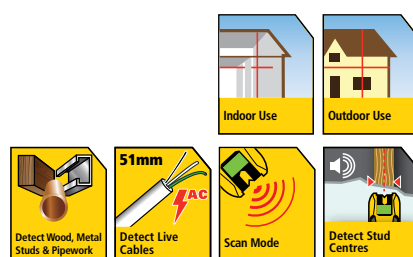

SKU #	Description	Wood & metal stud detection	AC live wire detection	Scan mode – ferrous metal detection	Scan mode – AC detection
FMHT0-77407	Stud Sensor	38mm max	51mm max	75mm max	51mm max

MOISTURE DETECTOR

Pro rating out of 5



- The Stanley® moisture meter provides accurate readings in wood and masonry with two 8mm replaceable detection pins
- The backlit LCD display indicates the moisture level on a bar graph showing results quickly and effectively.
- Measures moisture in wood from 6-44%. Readings over 15% are suspicious and need investigating, over 20% indicate decay.

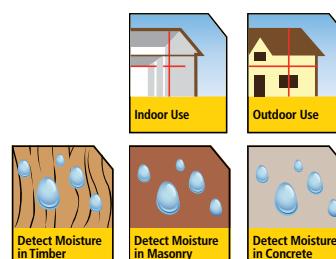

SKU #	Description	Detection range/accuracy (wood)	Detection range/accuracy (building materials)	Display Type	Electrode pins
0-77-030N	Moisture Detector	6 - 44% (+/-2%)	0.2 - 2.0% (+/-0.1%)	Backlit LCD	2 x 8mm

ACCESSORIES

The accessories available in the **STANLEY®** laser range are designed to help you get the most out of your tools and give you the spare parts you need when working on-site.

Lightweight and robust tripods and pole mounts provide additional on-site accuracy and capabilities for small line levels and hand held

TLM's and larger tripods give added stability and for rotary levels.

Remote controls allow one man operation, minimising manpower for quick results. Additional targets and detectors can extend the practical working ranges and capabilities of rotary, line or spot lasers.

LASER POLE, GLASSES & TRIPOD

3.6M EXTENSION POLE



STANLEY

- Can be used with lasers with 1/4" thread
- Extends up to 3.6m
- Can be used externally with tri-legs supplied

STANLEY	Description		
1-77-022	3.6m Extension Pole	Box	5

CAMERA TRIPOD



STANLEY

- Can be used with lasers with 1/4" thread
- Adjustable height from 44cm – 119cm for convenience
- Compact and stable

STANLEY	Description		
1-77-201	Camera Tripod	Box	2

LINE DETECTOR WITH CLAMP



**STANLEY
FATMAX**

- Accuracy 1mm/m
- Can be used up to 30m
- Audible 20mm display screen

STANLEY	Description		
1-77-023	Detector for Line Lasers	Box	1

LASER GLASSES



STANLEY

- Laser Glasses designed to enhance the brightness of the laser line internally and externally suitable for all lasers

STANLEY	Description		
1-77-171	Laser Glasses	Box	10

WARRANTY REPAIR AND CALIBRATION SERVICE

All **STANLEY**® laser products are supplied with a 1 year warranty from the date of purchase and our warranty covers manufacturing defects, but excludes general wear and tear. We advise that you have your **STANLEY**® laser product serviced annually and calibrated every 6 months to ensure precise measurement.

If your product is malfunctioning within or outside the warranty period please get in touch with your nearest After Sales Service Agent - refer to the addresses opposite to find your nearest agent.

You can also visit www.2helpU.com where you can find:

- Your nearest **STANLEY**® After Sales Service Agent
- The latest information about our spare parts
- Drawings, exploded views and instructions manuals
- Our full warranty policy

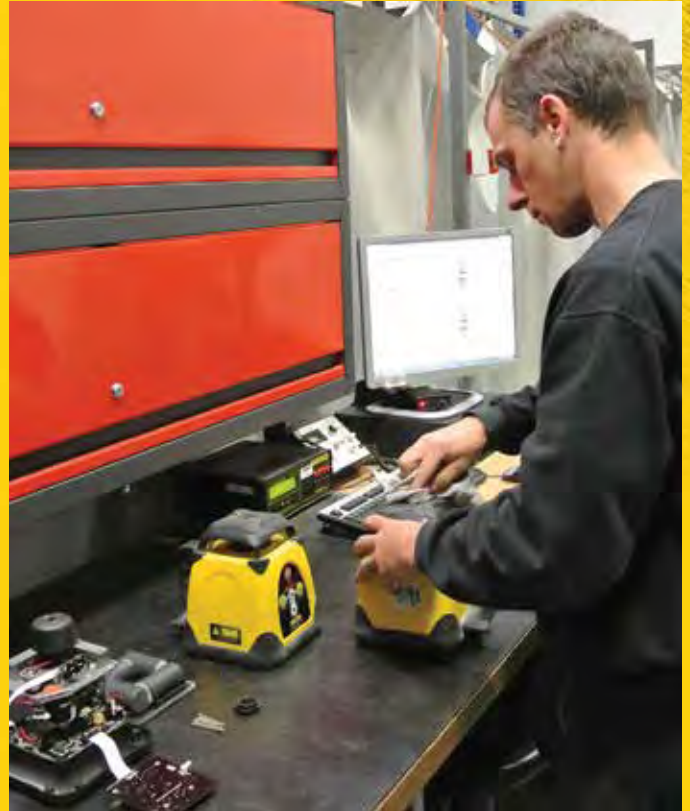

STANLEY®

MEASURING TOOLS



Short Tapes

Long Tapes

Rulers





GET THE JOB DONE ACCURATELY

STANLEY® is the pioneer in measuring tools. We invented the first steel tape rules in 1930. In 1963, the classic D-shaped **PowerLock®** design was introduced. It had the world's first coil-able spring and sliding lock, elements that continue to be the core of modern day designs. **PowerLock®** was also a part of Apollo 11's Lunar Landing Gear in 1969.

Our measuring tools offer consistent accuracy and ease of measurement. Short tapes, long tapes or rulers, each tool features various patented features that outshine industrial competitors. The materials used guarantee durability, and the focus on end-user productivity allows for a one

man job, making the tool a handy addition to every construction kit.

Cutting-edge hooking functions give accurate external and internal measurements. Diverse patented features and advanced materials are used to offer durability and originality. The innovative designs are made to facilitate all job site requirements, resulting in excellent end-user productivity.

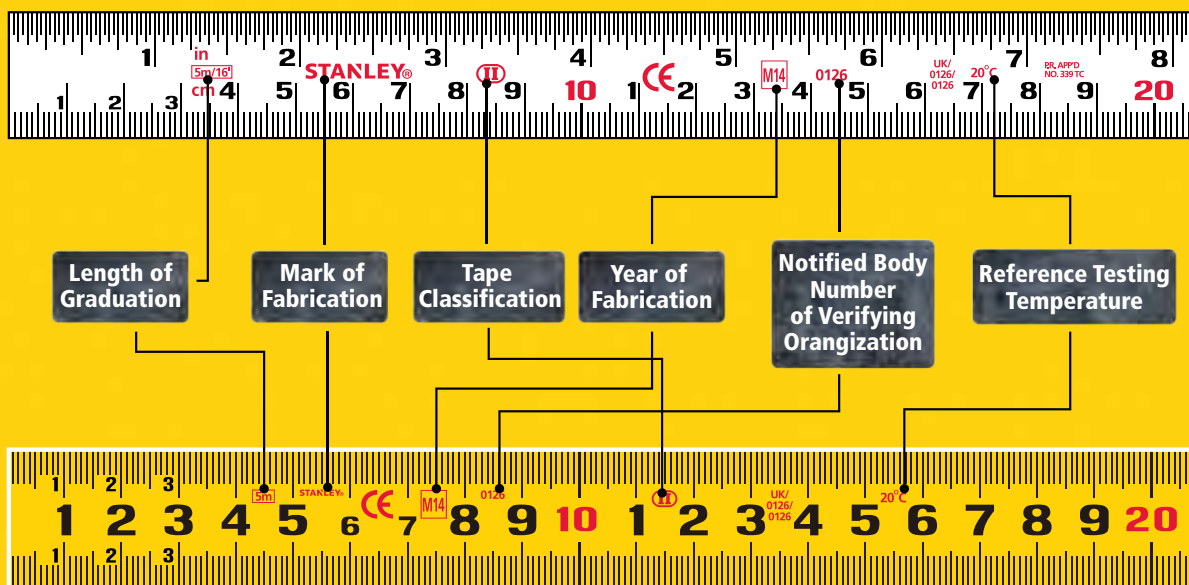

SHORT TAPE RULES OVERVIEW

PROFILE	CASE MATERIAL	SPECIFICATIONS								
		BLADE COLOR	BLADE PRINTING	BLADE COATING	BLADE WIDTH (mm)	BLADE STANDOUT (m)	METRIC		METRIC/IMPERIAL	
PowerLock®	Chrome Plated ABS	Yellow	1-sided	Mylar	13 19 25	-	-	-	●	3m/10' 3.5m/12' 5m/16' 8m/26' 10m/33'
Tough Case Tape Rule	ABS ABS+TPR	Yellow	1-sided	Nylon	13 19 25	1.4 1.8 2.3	●	3m 3.5m 5m 8m	●	3m/10' 3.5m/12' 5m/16' 8m/26'
Fatmax®	Bi-Mat	Yellow	1-sided	Mylar	32	3	-	-	●	5m/16' 8m/26'
Tylon	ABS/Rubber	Yellow	1-sided	Tylon	13 19 25	-	-	-	●	3m/10' 5m/16' 8m/26'
Rubbergrip Tape	ABS/Rubber	Yellow	1-sided	Lacqueur	12.7	-	●	3m 3.5m	-	-
Global Tape Yellow	ABS	Yellow	1-sided	Tylon	13 19 25	-	●	3m 5m 8m	●	3m/10' 5m/16' 8m/26'
Basic Tape	ABS	Yellow	1-sided	Lacqueur	13 19 25	1.5	-	-	●	3m/10' 5m/16' 8m/26'



TOUGHER THAN YOU THINK!

TOUGH CASE
TAPE RULE

STANLEY®

TOUGH CASE Short Tapes

- **>180cm** / 5M tape
(**5%** longer than competition)
- Preferred by **85%** of end users

GREAT STANDOUT



SKU#	Case Material	BLADE		
		LENGTH	WIDTH	STANDOUT
STHT30504-8	ABS	3m/10'	13mm	1.4m
STHT30510-8	ABS	3.5m/12'	13mm	1.4m
STHT30505-8	ABS	5m/16'	19mm	1.8m
STHT30506-8	ABS	8m/26'	25mm	2.3m
STHT30507-8	ABS+TPR	3m/10'	13mm	1.4m
STHT30511-8	ABS+TPR	3.5m/12'	13mm	1.4m
STHT30508-8	ABS+TPR	5m/16'	19mm	1.8m
STHT30509-8	ABS+TPR	8m/26'	25mm	2.3m



NYLON BLADE COATING

Offers **2X** Longer Life
Protects blade from scratches, rust & corrosion



BIG DOUBLE END HOOK

For autonomous use
Offers better grip above and below surface of measuring

Available In:

- ABS and ABS & TPR Cases
- 3m/10', 5m/16' & 8m/26' Range

POWERLOCK® TAPE RULES



- High impact chrome ABS case for tough onsite jobs
- Mylar polyester film extends life of entire blade
- Corrosion-resistant Tru-Zero® end hook for accurate measurements



SKU #	Description	Blade length	Blade Width	Blade Printing	Blade Graphics	Blade Coating	Box Qty
STHT33203-8	3m/10' x 13mm Metric/Imperial	3m/10'	13mm	1-sided	Regular	Mylar Yellow	6
STHT33215-8	3.5m/12' x 13mm Metric/Imperial	3.5m/12'	13mm	1-sided	Regular	Mylar Yellow	6
STHT33158-8	5m/16' x 19mm Metric/Imperial	5m/16'	19mm	1-sided	Regular	Mylar Yellow	6
STHT33428-8	8m/26' x 25mm Metric/Imperial	8m/26'	25mm	1-sided	Regular	Mylar Yellow	6
STHT33463-8	10m/33' x 25mm Metric/Imperial	10m/33'	25mm	1-sided	Regular	Mylar Yellow	6

TOUGH CASE TAPE RULES



- High visibility yellow blade
- Bi-material case provide comfortable, anti-slip grip
- Triangle shape offers improved stability
- Ergonomic 45° tilt clip for easy belt hook-on



SKU #	Description	Case Material	Blade Length	Blade Width	Standout	ACCURACY	Blade Coating	Box Qty
STHT30504-8	Tough Case 3m/10' x 13mm	ABS	3m/10'	13mm	1.4m	MID II	Nylon Yellow	6
STHT30510-8	Tough Case 3.5m/12' x 13mm	ABS	3.5m/12'	13mm	1.4m	MID II	Nylon Yellow	6
STHT30505-8	Tough Case 5m/16' x 19mm	ABS	5m/16'	19mm	1.8m	MID II	Nylon Yellow	6
STHT30506-8	Tough Case 8m/26' x 25mm	ABS	8m/26'	25mm	2.3m	MID II	Nylon Yellow	6
STHT30507-8	Tough Case Bi-Mat 3m/10' x 13mm	ABS+TPR	3m/10'	13mm	1.4m	MID II	Nylon Yellow	6
STHT30511-8	Tough Case Bi-Mat 3.5m/12' x 13mm	ABS+TPR	3.5m/12'	13mm	1.4m	MID II	Nylon Yellow	6
STHT30508-8	Tough Case Bi-Mat 5m/16' x 19mm	ABS+TPR	5m/16'	19mm	1.8m	MID II	Nylon Yellow	6
STHT30509-8	Tough Case Bi-Mat 8m/26' x 25mm	ABS+TPR	8m/26'	25mm	2.3m	MID II	Nylon Yellow	6

FATMAX® SHORT TAPE



MADE IN USA
WITH GLOBAL MATERIALS™

- Patented reverse lock mechanism
- BladeArmor® coating on the first 80mm and complete Mylar® coated blade
- Detachable hook
- Bi-material case for comfort

SKU #	Description
XTHT0-33503	5M/E X32 in Cutcase – Metric / Imperial
XTHT0-33504	8M/E X32 in Cutcase – Metric / Imperial

TYLON™ TAPE RULES



- Tylon coated blade provides anti-glare readings
- Soft touch case
- Tru-Zero® hook for accurate internal and external measurements



SKU #	Description	Blade length	Blade Width	Blade Printing	Blade Graphics	Blade Coating	Box Qty
STHT30686-8	3m/10' x 13mm Metric/Imperial	3m/10'	13mm	1-sided	Regular	Tylon	6
STHT30696-8	5m/16' x 19mm Metric/Imperial	5m/16'	19mm	1-sided	Regular	Tylon	6
STHT30656-8	8m/26' x 25mm Metric/Imperial	8m/26'	25mm	1-sided	Regular	Tylon	6

RUBBERGRIP® TAPE RULE



- Exclusive cushion grip built into case for comfortable non-slip and impact resistance
- Lacquered blade for maximum durability
- Improved blade readability with high contrast colour easy to read in all lighting conditions
- Massive bumper designed for increased hook life

SKU #	Blade Length		Blade Width		Box/CTN
	Feet	Meters	Inches	MM	
30-608L	-	3	½"	12.7	6/36
30-611L	-	3.5	½"	12.7	6/36

GLOBAL TAPE YELLOW BLADE TAPE RULES



- High-impact ABS case for durability
- Matt finish coating provides anti-glare readings
- Corrosion-resistant Tru-zero end hook for accurate measurements



SKU #	Description	Blade length	Blade Width	Blade Printing	Blade Graphics	Blade Coating	Box Qty
STHT30487-8	3m x 13mm Metric	3m	13mm	1-sided	Regular	Tylon	6
STHT30497-8	5m x 19mm Metric	5m	19mm	1-sided	Regular	Tylon	6
STHT30457-8	8m x 25mm Metric	8m	25mm	1-sided	Regular	Tylon	6
STHT30486-8	3m/10' x 13mm Metric/Imperial	3m/10'	13mm	1-sided	Regular	Tylon	6
STHT30496-8	5m/16' x 19mm Metric/Imperial	5m/16'	19mm	1-sided	Regular	Tylon	6
STHT30496-31L	5m/16' x 19mm Metric/Imperial (FCB Tape)	5m/16'	19mm	1-sided	Regular	Tylon	6
STHT30456-8	8m/26' x 25mm Metric/Imperial	8m/26'	25mm	1-sided	Regular	Tylon	6

STANLEY® BASIC TAPE RULES



- High-impact ABS case for durability
- Corrosion-resistant Tru-Zero® end hook for accurate measurements



SKU #	Description	Blade length	Blade Width	Standout	Blade Printing	Blade Coating	Box Qty
STHT30204-8	3m/10' x 13mm Metric/Imperial	3m/10'	13mm	1.5m	1-sided	Lacqueur Yellow	6
STHT33989-8	5m/16' x 19mm Metric/Imperial	5m/16'	19mm	1.5m	1-sided	Lacqueur Yellow	6
STHT33994-8	8m/26' x 25mm Metric/Imperial	8m/26'	25mm	1.5m	1-sided	Lacqueur Yellow	6

LONG TAPE RULES OVERVIEW

	TAPE	CASE MATERIAL	BLADE MATERIAL	BLADE WIDTH	METRIC		METRIC/IMPERIAL	
Fiberglass Blade Long Tape Rules	Open Reel	ABS	Fiberglass	1/2"	•	20m 30m 50m	•	3m/10' 5m/16' 8m/26'
Open Reel Fiberglass Blade Long Tape Rules	Open Reel	ABS	Fiberglass	1/2"	-	-	•	30m/100' 60m/200'
Steel Blade Long Tape Rules	Close Case	ABS	Steel	3/8"	-	-	•	15m/50' 30m/100'

FIBERGLASS BLADE LONG TAPE RULES



- High-impact case for durability
- Reinforced fiberglass blade for accurate measurements
- High visibility case make it easy to detect on the job

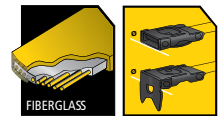

SKU #	Description	Blade length	Blade Width	Blade Material	Accuracy	Blade Print	Blade Color	Box Qty
STHT34260-8	15m/50' Metric/Imperial	15m/50'	1/2"	Fiberglass	II (Metric only)	2-sided	Yellow	6
STHT34262-8	30m/100' Metric/Imperial	30m/100'	1/2"	Fiberglass	II (Metric only)	2-sided	Yellow	6
STHT34263-8	50m/165' Metric/Imperial	50m/165'	1/2"	Fiberglass	II (Metric only)	2-sided	Yellow	6
STHT34296-8	20m Metric	20m	1/2"	Fiberglass	II (Metric only)	2-sided	Yellow	6
STHT34298-8	50m Metric	50m	1/2"	Fiberglass	II (Metric only)	2-sided	Yellow	6

OPEN REEL FIBERGLASS BLADE LONG TAPE RULES



- Double sided blade graphics for an easy read
- Corrosion-resistant Tru-zero folding end hook for accurate measurements
- Grip handle for comfortable portage

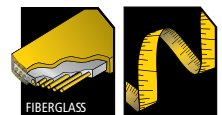

SKU #	Description	Blade length	Blade Width	Blade Material	Accuracy	Blade Print	Blade Color	Box Qty
STHT34791-8	30m/100' Metric/Imperial	30m/100'	1/2"	Fiberglass	II (Metric)	2-sided	Yellow	2
STHT34794-8	60m/200' Metric/Imperial	60m/200'	1/2"	Fiberglass	II (Metric)	2-sided	Yellow	2
34-777	100m/300' Metric/Imperial	100m/300'	1/2"	Fiberglass	III (Metric)	2-sided	Yellow	2

STEEL BLADE LONG TAPE RULES

- Polymer coated blade withstands abrasion
- Easy-wind drum for efficient retraction
- Belt clip for hands-free usage and convenient transportation



SKU #	Description	Blade length	Blade Width (in.)	Blade Material	Blade Print	Blade Color	Box Qty
STHT34104-8	15m/50' Metric/Imperial	15m/50'	3/8"	Steel	1-sided	Yellow	6
STHT34107-8	30m/100' Metric/Imperial	30m/100'	3/8"	Steel	1-sided	Yellow	6

STRAIGHT EDGE RULER

- Matt finish and anti-glare for accurate readability
- Anti-rust and stainless body



SKU #	Description	Length (mm)	Width (mm)	Thickness (mm)	Box Qty
35-344	150mm Stainless Edge Ruler	150	15	0.6	24
35-345	300mm Stainless Edge Ruler	300	25	1	24
35-346	600mm Stainless Edge Ruler	600	25	1	20
35-347	1000mm Stainless Edge Ruler	1000	30	1.5	10
35-348	1500mm Stainless Edge Ruler	1500	38	1.8	10

STANLEY®

LAYOUT TOOLS



Levels

Squares

Marking Tools





NEVER COMPROMISE ACCURACY

Straight lines and angles will never be a problem again, not if **STANLEY®** is involved. For over 150 years, **STANLEY®** has been perfecting and making layout tools. Featuring levels, squares and chalk line markings, this category promises precision and distinction.



LEVELS

We design and build a wide variety of levels, including the box-beam, I-beam, torpedo, magnetic and adjustable-vial models. Each individual level has its own distinct benefits that permit the user to read and mark any angle between 0 and 90 degrees.



SQUARES

Our Try Square features a lightweight aluminum body with a durable plastic handle. It is ideal for laying out 45° and 90° angles.



MARKING TOOLS

STANLEY® Marking Tools include chalk lines and refills. These provide very easy usage, good adhesion and high visibility.

LEVELS OVERVIEW

PROFILE	BODY MATERIAL	SPEC					
		PRIMARY UTILE SURFACE ACCURACY	# OF VIALS	LENGTH (in.)	LENGTH (mm)	MAGNET	
Torpedo	Hi Impact Torpedo Level	ABS+TPR	2mm/m	3	9"	299	●
	Plastic Torpedo Level	ABS	2mm/m	3	8"	200	●
	Plastic Torpedo Level	ABS	2mm/m	3	9"	299	●
	Die Cast Torpedo Level	Aluminum	1.5mm/m	3	9"	299	●
Box-Beam	STANLEY® Classic Box-Beam	Aluminum	0.5mm/m	2~3	12", 16", 24", 31", 39", 48", 59", 72", 78"	300, 400, 600, 800, 1000, 1200, 1500, 1800, 2000	-
	Fatmax® II Level	Aluminum	0.5mm/M	3	24" 36" 48" 72"	600 900 1200 1800	● (43-525, 43-537, 43-549)
I-Beam	Foam Casing	ABS	2mm/m	3	12" 18" 24" 48"	300 450 600 1200	-
	Thrifty	Aluminum	2mm/m	2~3	12" 18" 24" 36" 48"	300 450 600 900 1200	-
	Fatmax® I-Beam Level	Aluminum	1mm/m	3	24" 48" 72"	600 1200 1800	● (43-554, 43-556, 43-558)

HI IMPACT TORPEDO LEVEL



- Heavy-duty aluminum frame for accuracy and durability
- Open level vial provides maximum readability
- Magnetic base allows hands-free operation on metal surfaces

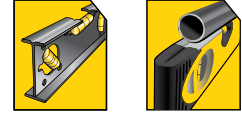

SKU #	Description	Length (in.)	Length (mm)	Top Read Vial	Plumb Vial	45° Vial	Box Qty
STHT43511-8	STANLEY® 9" Hi Impact Torpedo Level	9"	229	1	1	1	6

PLASTIC TORPEDO LEVEL



- High-impact ABS body provides durability
- Clear visibility from above because of top-reading vial
- Tinted 360° vials to provide distinct readability

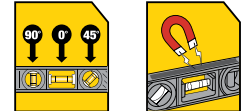

SKU #	Description	Length (in.)	Length (mm)	Top Read Vial	Plumb Vial	45° Vial	Box Qty
STHT42291-8	STANLEY® 8" Plastic Torpedo Level	8"	200	1	1	1	6

PLASTIC TORPEDO LEVEL



- High-impact ABS body provides durability
- Top-reading feature allows clear visibility from above
- Tinted 360° vials make measurements easy on the eyes

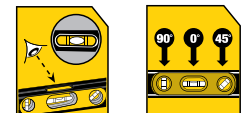

SKU #	Description	Length (in.)	Length (mm)	Top Read Vial	Plumb Vial	45° Vial	Box Qty
STHT42264-8	STANLEY® 9" Plastic Torpedo Level	9"	229	1	1	1	6

DIE CAST TORPEDO LEVEL



- Durable, heavy-duty, cast aluminum frame
- Features large, top-read vial window
- Pipe groove enables use on rounded surfaces

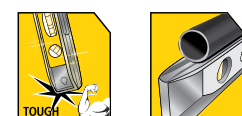

SKU #	Description	Length (in.)	Length (mm)	Top Read Vial	Plumb Vial	45° Vial	Box Qty
STHT42465-8	STANLEY® 9" Die Cast Torpedo Level	9"	229	1	1	1	6

STANLEY®

CLASSIC BOX-BEAM LEVEL

The **STANLEY®** CLASSIC BOX-BEAM features a wide range of levels that come in various sizes. New features offer better visibility, readability, durability and accuracy.

SOFT MATERIAL
used to make shock-absorbing end caps

EXCELLENT ACCURACY

center vial with 0.05mm/1m

2 PLUMB VIALS

for easy readability

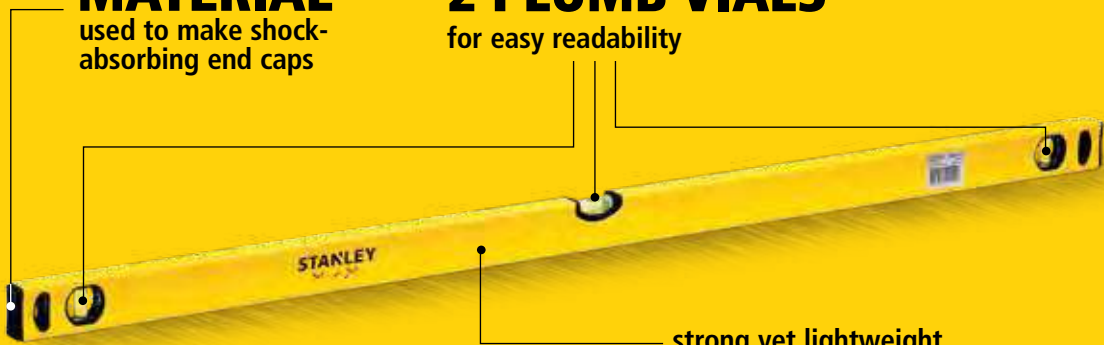

strong yet lightweight

ALUMINUM FRAME
suitable for all-purpose durability



MILLING SURFACE
to provide better accurate measurement

USER TIPS

- The hang-hole allows for easy storage
- Measuring can be done from either direction, offering excellent accuracy

SKU #	Description	Length (in.)	Length (mm)	Top Read Vial	Plumb Vial	Hang Holes
STHT43118-8	Stanley® Classic Box Beam Level 30Cm/12"	12"	300	1	1	1
STHT43102-8	Stanley® Classic Box Beam Level 40Cm/16"	16"	400	1	1	1
STHT42521-8	Stanley® Classic Box Beam Level 40Cm/16" (3 Vials)	16"	400	1	2	1
STHT43103-8	Stanley® Classic Box Beam Level 60Cm/24"	24"	600	1	1	1
STHT42522-8	Stanley® Classic Box Beam Level 60Cm/24" (3 Vials)	24"	600	1	2	1
STHT43104-8	Stanley® Classic Box Beam Level 80Cm/31"	31"	800	1	1	1
STHT42523-8	Stanley® Classic Box Beam Level 80Cm/31" (3 Vials)	31"	800	1	2	1
STHT43105-8	Stanley® Classic Box Beam Level 100Cm/39"	39"	1000	1	2	2
STHT43106-8	Stanley® Classic Box Beam Level 120Cm/48"	48"	1200	1	2	2
STHT43107-8	Stanley® Classic Box Beam Level 150Cm/59"	59"	1500	1	2	2
STHT43108-8	Stanley® Classic Box Beam Level 180Cm/72"	72"	1800	1	2	2
STHT43109-8	Stanley® Classic Box Beam Level 200Cm/78"	78"	2000	1	2	2

FATMAX® II LEVEL

- Built from a single piece of aluminum extrusion for increased durability and rugged use
- A center MaxEdge™ vial enables users to scribe continuous lines with an improved view
- Features 2 block vials on each end to provide maximum accuracy
- Dual bi-material



SKU #	Description	Length (in.)	Length (mm)	Top Read Vial	Plumb Vial	Hang Holes	Hand Holes	Magnet	Box Qty
1-43-524	FatMax® II Level 24"/60cm	24"	600	1	2	2	1	–	6
43-536	FatMax® II Level 36"/90cm	36"	900	1	2	2	1	–	6
43-548	FatMax® II Level 48"/120cm	48"	1200	1	2	2	2	–	3
43-525	FatMax® II Level 24"/60cm(Magnetic)	24"	600	1	2	2	1	•	3
43-537	FatMax® II Level 36"/90cm(Magnetic)	36"	900	1	2	2	1	•	6
43-549	FatMax® II Level 48"/120cm(Magnetic)	48"	1200	1	2	2	2	•	6

FOAM CAST LEVEL



- Durable, shock-resistant ABS construction
- Measuring scale adds utility
- Non-marring material helps prevent damage to finished surfaces



SKU #	Description	Length (in.)	Length (mm)	Top Read Vial	Plumb Vial	45° Vial	Hang Holes	Hand Holes
STHT42467-8	18" Foamcast Level	18"	450	1	1	1	1	2
STHT42468-8	24" Foamcast Level	24"	600	1	1	1	1	2
STHT42470-8	48" Foamcast Level	48"	1200	1	1	1	1	2

24" I-BEAM LEVEL MID-GRADE RANGE



- Level accuracy of 0.0015 in./in. (1.5mm/m)
- 360 ° vials set directly into frame never need adjustment
- Heavy-duty aluminum I-beam construction provides rigidity and accuracy

SKU #	Description	Material	Length (mm)	Magnetic	VIALS
42-244	24" i-beam level	Aluminum	24"	Yes	3

FATMAX® I-BEAM LEVEL



Shock Absorbing End Caps



MaxEdge Center Vial



Straight Edge for Fast Measurements

- Ergonomic Aluminum body removes excess dirt and prolongs life
- Magnified center vial for increased user comfort
- Vials with accuracy of 0.5mm/m for improved exactness
- MaxEdge center vial : bridged center vial for continuous marking surface
- Pencil clip included for convenient marking
- Shock absorbing end caps makes it long lasting and shock resistant

SKU #	Description	Length (in.)	Length (mm)	Top Read Vial	Plumb Vial	Hang Holes	Hand Holes	Manget	Box Qty
43-553	FatMax® I-Beam Level 24"/60cm	24"	600	1	2	2	1	–	2
43-555	FatMax® I-Beam Level 48"/120cm	48"	1200	1	2	2	2	–	2
43-557	FatMax® I-Beam Level 72"/180cm	72"	1800	1	2	2	2	–	2
43-554	FatMax® I-Beam Level 24"/60cm(Magnetic)	24"	600	1	2	2	1	•	2
43-556	FatMax® I-Beam Level 48"/120cm(Magnetic)	48"	1200	1	2	2	2	•	2
43-558	FatMax® I-Beam Level 78"/200cm(Magnetic)	78"	2000	1	2	2	2	•	2

THRIFTY



- Durable, lightweight aluminum construction for all purpose use
- Yellow vial covers increase visibility and readability
- Comfortable hand holes for easy handling

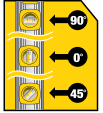

SKU #	Description	Length (in.)	Length (mm)	Top Read Vial	Plumb Vial	45° Vial	Hang Holes	Hand Holes
STHT42072-8	12" Thrifty Levels	12"	300	1	1	–	1	–
STHT42073-8	18" Thrifty Levels	18"	450	1	1	1	1	–
STHT42074-8	24" Thrifty Levels	24"	600	1	1	1	1	1
STHT42075-8	36" Thrifty Levels	36"	900	1	1	1	1	1
STHT42076-8	48" Thrifty Levels	48"	1200	1	1	1	2	2

TRY SQUARE

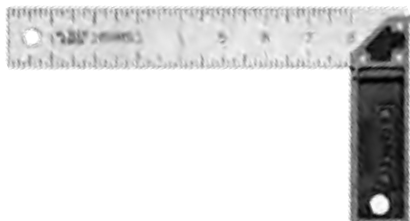

- Try square with stamped graduations and figures
- Cast Zinc handle
- Metric/Imperial marking on ruler



SKU #	Description	Blade (in.)	Blade (mm)	Handle (in.)	Handle(mm)
STHT46530-8	6" Try Square	6"	152	4-7/8"	124
STHT46532-8	8" Try Square	8"	203	4-7/8"	124
STHT46534-8	10" Try Square	10"	254	7-1/4"	184
STHT46536-8	12" Try Square	12"	305	7-1/4"	184

STANLEY® STEEL CARPENTER SQUARE



- Tempered steel designed for durability
- Deep graduations for easy reading on face and back
- Surface protected with a clear finish that resists rust
- Reverse reading scale makes measuring more efficient

SKU #	Finish	Length		Graduation		Box/CTN
		Body	Tongue	Face	Back	
45-500 (Imperial)	Buffed	24" x 12"	16 x 1- 1/2"	1/8"	1/8"	1/4
45-600 (M/E)	Buffed	24" x 16"	16" x 1-1/2"	1/8"	1/8"	6/6

STANLEY® RAFTER / ROOFING SQUARE



- Embossed graduations and figures on work-hardened steel
- Metric roofing table
- Buffed finish with a clear lacquer that resists rust

SKU #	Finish	Length		Graduation		Box/CTN
		Body	Tongue	Face	Back	
45-530 (Metric)	Buffed	600 x 500mm	400 x 8mm	2mm	2mm	6/6

COMBINATION SQUARE

- Try square with stamped graduations and figures
- Cast zinc handle
- Metric / Imperial marking on ruler

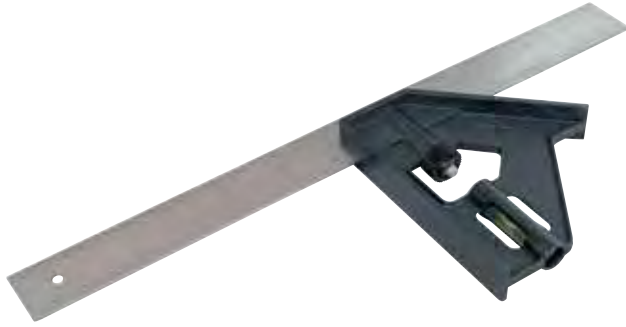

SKU #	Description	Length inches	# of Vials	Box/CTN
46-012	12"	36"	3	6/6
46-028	Die Cast	48"	3	3/3

STANLEY® BEVEL EDGE

- High carbon steel-tempered blade
- Nickel-plated
- Tough plastic handle



SKU #	Description		O/A Length		Box/CTN
	mm	Inches	mm	Inches	
46-825-0	203	8"	140	5-1/2"	6/36

CHALK LINE



- Stainless steel end hook for added durability and rust prevention
- High impact ABS case for durability
- Sliding door for quick and easy refill

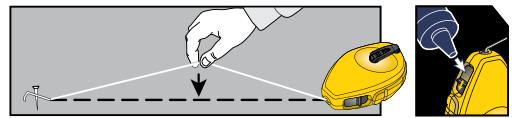

SKU #	Description	Chalk Line Length (ft.)	Chalk Line Length (m)	Chalk Refill Weight (oz)	Chalk Refill Weight (g)	Box Qty
STHT47440-8	Chalk Line Reel	100	30	-	-	6
STHT47442-8	Chalk Line Reel, Blue Chalk 4 oz	100	30	4	113	-
STHT47443-8	Chalk Line Reel, Blue Chalk 4 oz & Plastic Line Level	100	30	4	113	2
47-460	Chalk Line Powerwinder®	100	30	-	-	1

CHALK REFILL

- Powder specially formulated for good adhesion and high visibility
- Water resistant
- Good resistance to all atmospheric conditions



SKU #	Description	Weight (oz)	Weight (g)
STHT47403-8	Chalk Refill Blue 4 oz	4	113
STHT47404-8	Chalk Refill Red 4 oz	4	113

STANLEY®

STORAGE SOLUTIONS



Roller Cabinets

On Wheels

Toolboxes

Tool Bags

Organizers

Workbenches



PRACTICAL STORAGE SOLUTION



INTEGRATED STORAGE SYSTEM AND MODULE TRAYS, BRINGING MORE FLEXIBILITY TO FREELY MANAGE TOOLS ACCORDING TO YOUR DEMAND.



PROVEN DURABILITY FOR HEAVY JOBS!

While on the job, users tend to open and shut the drawers of their storage solutions multiple times to access the necessary tools. Consistently putting uneven force on the drawers can lead to their distortion and eventual break down. To ensure their durability, all **STANLEY®** storage products are laden down and tested with a variety of weights. These drawers and lids are then

REPEATEDLY OPENED AND CLOSED THOUSANDS OF TIMES

to ensure that their structure and functionality remain in the best condition.



TOUGH ENOUGH TO CARRY ALL!

ALL STANLEY® STORAGE PRODUCTS ARE DESIGNED TO WITHSTAND THE TOUGHEST CONDITIONS.

Storage products are essentially built to sustain heavy loads without incurring any distortion or damage. **STANLEY®** has conducted a myriad of tests that continuously load force onto and within each storage space to ensure that each structure is firm, strong and durable.



STANLEY® ROLLER CABINET

MOBILE STORAGE CART

COMPATIBLE with
**TRANS
MODULE**
system

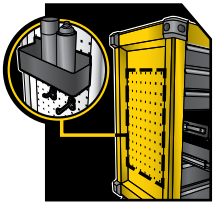

Perforated side panels for more storage options.



Ball bearing slide for smooth and heavy loading drawer operation.

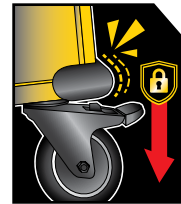

Two lockable 4" x 2" swivelling PP castors for easy maneuverability and secure parking.

Corner bumpers protect against impact damage.

X 3

EACH DRAWER OF ROLLER CABINET ACCOMMODATES 3 MODULES, YOU MAY ADJUST THE CONFIGURATION ACCORDING TO YOUR OWN WORKING PREFERENCE.

* Refer to page 182-187 for STANLEY® Transmodule System details



4 DRAWERS ROLLER CABINET



COMPATIBLE with
**TRANS
MODULE**
system

- Multiple drawer sizes for flexible storage options
- Perforated side panels for more storage options
- Ball bearing slides for smooth and heavy loading drawer operation
- Lockable castors
- PVC bumpers on corners
- Lockable drawers

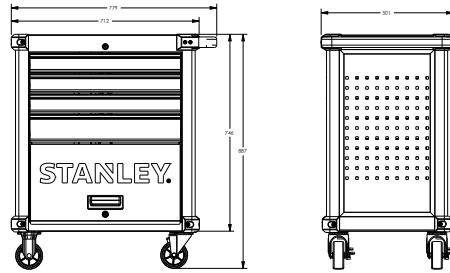

SKU #	Description	Overall Dimension (Length x Width x Height mm)	Effective Drawer Dimension (mm)	Total Load Capacity (kg)	Drawer Load Capacity (kg)	Compartment Load Capacity (kg)	Drawer Qty
STST74305-8	4 Drawers Roller Cabinet	690 x 426 x 889	Top 3: 540 x 408 x 72 Bottom 1: 540 x 408 x 105	300	20	35	4

7 DRAWERS ROLLER CABINET



COMPATIBLE with
**TRANS
MODULE**
system

- Multiple drawer sizes for flexible storage options
- Perforated side panels for vertical storage
- Ball bearing slides for smooth and heavy loading drawer operation
- Lockable castors
- PVC bumpers on corners
- Lockable drawers

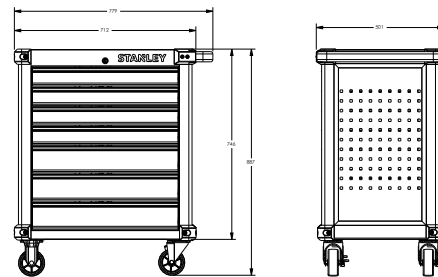

SKU #	Description	Overall Dimension (Length x Width x Height mm)	Effective Drawer Dimension (mm)	Total Load Capacity (kg)	Drawer Load Capacity (kg)	Compartment Load Capacity (kg)	Drawer Qty
STST74306-8	7 Drawers Roller Cabinet	690 x 426 x 889	Top 4: 540 x 408 x 72 Bottom 3: 540 x 408 x 105	300	20	–	7

4 DRAWERS ROLLER CABINET WITH ABS TOP TRAY



COMPATIBLE with
**TRANS
MODULE**
system

- Ball bearing slides for smooth and heavy loading drawer operation
- ABS top tray
- Side folding shelf
- Lockable wheel with rubber castors
- Side can and screwdriver holders
- Rubber bumpers on corners
- Lockable drawers

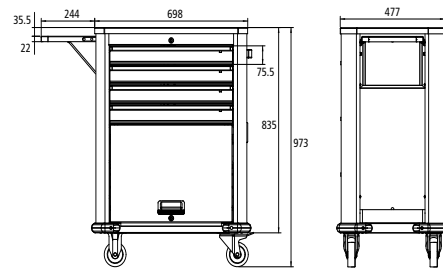

SKU #	Description	Overall Dimension (Length x Width x Height mm)	Effective Drawer Dimension (mm)	Total Load Capacity (kg)	Drawer Load Capacity (kg)	Compartment Load Capacity (kg)	Drawer Qty
STMT99069-8	4 Drawers Roller Cabinet	698 x 477 x 973	536 x 410 x 75.5	300	25	35	4

18" CASE TROLLEY CART

NEW



- Carries up to 4 tool set cases for better organization with tool/cart sharing
- 2 sides vertical tool storage on top shelf
- 4 swivel castors for ease of operation

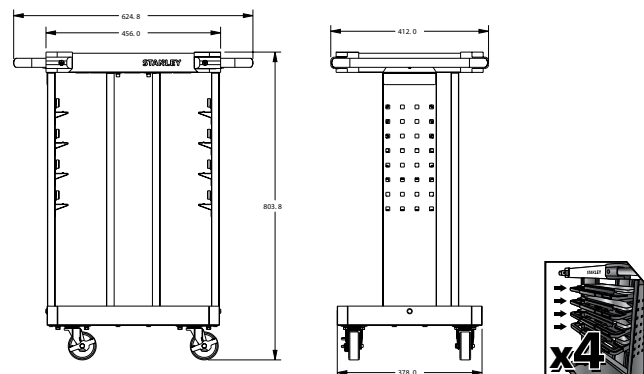

SKU #	Description	Overall Dimension (Length x Width x Height) (in mm)	Shelf Load Capacity (kg)	Total Load Capacity (kg)
STST74316-8	18" Case Trolley Cart	412 x 456 x 805	50	22

16" METAL CANTILEVER TOOLBOX

The **STANLEY®** 16" Metal Cantilever Toolbox is a one-of-a-kind storage solution for improved efficiency. The toolbox offers a duo layer design for simple organization and unique user-facing storage space for quick tool access.

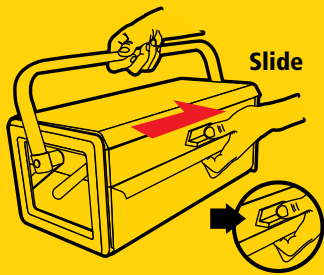

Long handle makes it easy to carry around and maneuver.

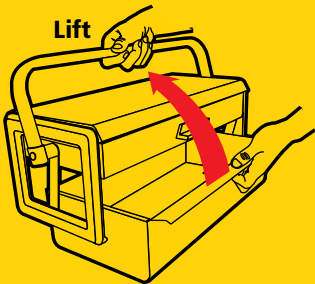

USER FACING DESIGN



“ UTILIZE THE FULL TRAY SPACE AND STORE BULKIER TOOLS COMPARED TO OTHER SIMILAR SIZED CANTILEVER TOOLBOXES ”

COMPATIBLE with
**TRANS
MODULE**
system

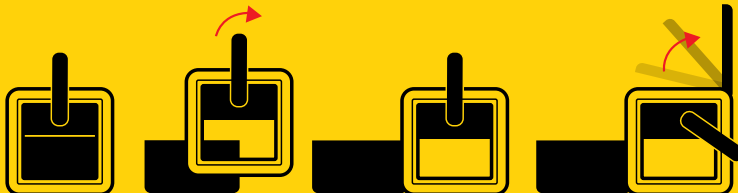

“ SMART BUMPER PROTECTS THE SIDE AND OFFERS SUPPORT BY SERVING AS A STAND ”

* Refer to page 182-187 for STANLEY® Transmodule System details

SKU #	Description	Length (mm)	Width (mm)	Height (mm)	Weight (kg)	Total Load Capacity (kg)	Drawer Load Capacity (kg)	Drawer / Layer Quantity
STST73097-8	16" Metal Toolbox - Cantilever 2 Layers	403	189	169	3.2	16	4.5	1

19" METAL TOOLBOX



STST73099-8

- One-handed operation
- Long handle

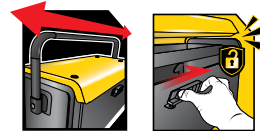
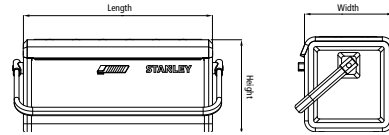

**GOOD DESIGN
AWARD 2014**



COMPATIBLE with
**TRANS
MODULE**
system

STST73100-8

- One-handed operation
- Long handle
- Auto sliding drawer

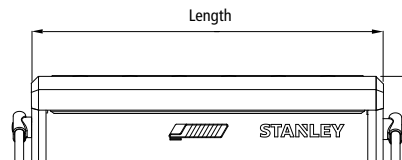

COMPATIBLE with
**TRANS
MODULE**
system

STST73101-8



- One-handed operation
- Long handle
- Central lock mechanism
- Ball bearing drawer slides

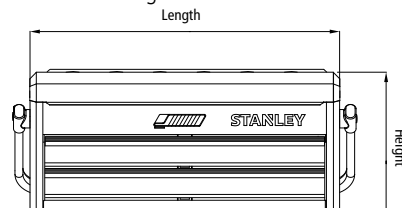

SKU #	Description	Overall Dimension (mm)	Effective Drawer Dimension (mm)	Weight (kg)	Total Load Capacity (kg)	Drawer Load Capacity (kg)	Drawer / Layer Quantity
STST73099-8	19" Metal toolbox - no drawer	471 x 221 x 236	-	3.4	20	-	-
STST73100-8	19" Metal toolbox - 1 drawer	471 x 221 x 236	403.8 x 184 x 77	4.5	20	4.5	1
STST73101-8	19" Metal toolbox - 2 drawers	471 x 221 x 236	405 x 189.5 x 47	5.9	20	4.5	2

FM 30GL/113L PROMOBILE JOBCHEST™



- Tough and big enough to fit more tools and accessories
- Big wheels and telescopic handle making it easier to move around on uneven surfaces and stairs
- 113 liter volume, 50 kg capacity

SKU #	Description	Length (mm)	Width (mm)	Height (mm)	Weight (kg)	Latch
1-94-850	FM 30GL/113L Promobile Jobchest™	516	431	12.7	12.76	Metal

FATMAX® CANTILEVER ROLLING WORKSHOP



- Opens up easily into a 4 level workstation
- Heavy duty road tested wheels
- Large adjustable organizer for nails, screws and other small components
- Large adjustable organizer for nails, screws and other small components
- 82 Liter volume, 50 kg capacity

SKU #	Description	Length (mm)	Width (mm)	Height (mm)	Weight (kg)	Latch
1-94-210	Fatmax® Cantilever Rolling Workshop	550	370	740	9.6	Metal

ONE TOUCH LATCH CONTRACTOR



- Portability of large tools
- Removable organizer on lid
- Over molded metal pull handle
- 2/3 size portable tray allows for storage of larger/longer tools
- 45 liter volume, 40 kg capacity

SKU #	Description	Length (mm)	Width (mm)	Height (mm)	Weight (kg)	Latch
STST33080	One Touch Latch Contractor	621	382	423	3.37	Metal

ROLLING WORKSHOP



- 3 in 1 storage options: tool box, organizer, storage bin
- Large bottom bin
- Middle carrousel organizer
- Large wheels
- Foldable handle
- 39 liter volume, 20 kg capacity

SKU #	Description	Length (mm)	Width (mm)	Height (mm)	Weight (kg)	Latch
STST18603	Rolling Workshop	470	295	619	4.34	Metal

3-IN-1 MOBILE WORK CENTER



MADE IN
USA
WITH GLOBAL MATERIALS™

- Includes detachable tool box unit + portable organizer + large bottom bin - the solution for all tool storage needs
- Removable tray allows enough space for larger tools to be stored underneath
- Portable organizer for small parts with multiple compartments which can be carried outside of the main unit
- Large bottom bin for larger hand tools and power tools
- Metal front and side latches for heavy duty usage - side latches can be clicked shut with or without organizer

SKU #	Description	Length (mm)	Width (mm)	Height (mm)	Weight (kg)	Latch
STST18613	3 -in-1 Mobile Work Center	469.9	279.4	629.92	4.85	Metal

WHEELED CONTRACTOR BOX



- Mobile fittings box with removable organizer
- Heavy-duty wheels for safety and comfort
- Robust handle
- 37 liter volume, 50 kg capacity

SKU #	Description	Length (mm)	Width (mm)	Height (mm)	Weight (kg)	Latch
1-92-904	Wheeled Contractor Box 33025	620	375	425	6.2	Metal
STST33026	PRO Contractor	620	375	425	5.66	Metal

PLASTIC TOOLBOX STORAGE LINE



METAL LATCH

Durable and anti-rust metal latch

REMOVABLE ORGANIZER

Removable organizer on the lid of the toolbox

INTERNAL TRAY

Comes with internal tray inside the toolbox

STRUCTURAL FOAM TOOLBOX WATERSEALED



- Waterproof storage solution
- All round water seal ensures safe and dry storage
- Constructed of structural foam for extra strength
- Extra large storage capacity
- Tough ergonomic soft grip handle allows heavy loads to be carried with ease
- Large metal rust proof latches with padlock for locking possibilities

SKU #	Description	Length (mm)	Width (mm)	Height (mm)	Weight (kg)	Latch
1-94-749	23" Structural Foam toolbox	580	208	269	3	Metal
1-93-935	28" Structural Foam toolbox	710	320	295	4.25	Metal

20" METAL-PLASTIC BOX



- Durable metal body
- Big metal latches
- Easy-grip coated handle

HEAVY DUTY

SKU #	Description	Length (mm)	Width (mm)	Height (mm)	Weight (kg)	Latch
STST20060	20" Metal-Plastic Box	497	293	222	2.4	Metal

20" PRO TOOLBOX



- Long metal handle
- Big metal latches
- Internal tray

HEAVY DUTY

SKU #	Description	Length (mm)	Width (mm)	Height (mm)	Weight (kg)	Latch
STST20300	20" PRO Toolbox	567	521	811	2.3	Metal

PORTABLE TOTE TRAY



- Constructed from high strength weatherproof plastic
- Adjustable and removable dividers
- Detachable case with integrated handle
- Heavy duty anti-rust metal latches
- Tough polycarbonate lid for extreme protection

SKU #	Description	Length (mm)	Width (mm)	Height (mm)	Weight (kg)	Latch
STST1-70317	19" Tote + Organizer	556	320.2	249	2.98	Metal
1-97-514	24" Tote + Organizer	670	320	250	3.53	Metal
STST1-70736	19" Organizer	500	95	330	1.6	Metal
STST1-79203	24" Organizer	610	95	330	1.95	Metal

25" ANTI SHOCK BOX



- Impact-absorbing and slip-resistant feet
- Two built into the lid organizer
- Aluminium padlock
- Transparent organizer flap

SKU #	Description	Length (mm)	Width (mm)	Height (mm)	Weight (kg)	Latch
1-70-353	25" Anti Shock Box	635	280	267	2.9	Metal

18" STRUCTURAL FOAM CANTILEVER TOOLBOX



- Robust and compact for high durability and easy transport
- Protruding compartments for clearly arranged storage and easy access
- Large main compartment – ideal for power tool storage
- Splash proof to the IP53 standard

SKU #	Description	Length (mm)	Width (mm)	Height (mm)	Weight (kg)	Latch
FMST1-71219	18" Structural Foam Cantilever Toolbox	457	236	310	3.5	Metal

CLICK 'N CONNECT™



MADE IN
USA
WITH GLOBAL MATERIALS™

- Stack multiple units for flexible storage structures
- Hinge+Latch feature allows the toolbox to be opened from both sides
- Removable dividers for customizable storage solutions

SKU #	Description	Length (mm)	Width (mm)	Height (mm)	Weight (kg)	Latch
STST14440	Click 'N Connect™ Organizer	505	290	90	1.3	Plastic
STST19950	Click 'N Connect™ Toolbox	505	310	165	1.6	Plastic
STST19900	Click 'N Connect™ 2 IN 1 Box & Organizer	505	310	245	2.9	Plastic

STANLEY® ONE LATCH



16"



19"

- Single latch one-hand operation
- Organizer on lid
- Internal tray

SKU #	Description	Length (mm)	Width (mm)	Height (mm)	Weight (kg)	Latch
STST16410	16" New Stanley® Plastic Latch	394	220	162	1.1	Plastic
STST19410	19" New Stanley® Plastic Latch	486	266	236	2.0	Plastic
STST16400	16" New Stanley® Metal Latch	394	220	162	1.1	Metal
STST19400	19" New Stanley® Metal Latch	486	266	236	2.0	Metal

22" TOOLBOX W/ TPR CORNERS & ALU LATCHES



- Large metal closures
- Lid organizer
- Removable tool tray

SKU #	Description	Length (mm)	Width (mm)	Height (mm)	Weight (kg)	Latch
1-97-512	22" Toolbox w/ TPR corners & alu latches	556	257	248	2.2	Metal

19" CLEAR LID METAL LATCH



- Organizer on lid with clear cover
- Metal latches
- Internal tray

SKU #	Description	Length (mm)	Width (mm)	Height (mm)	Weight (kg)	Latch
STST19061	19" Clear Lid Metal Latch	483	260	250	1.6	Metal

TOOLBOX



19"

22"

- Organizer top lid with clear cover
- Durable metal latch
- Internal tray

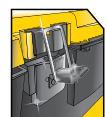

SKU #	Description	Length (mm)	Width (mm)	Height (mm)	Weight (kg)	Latch
STST74303-8	19" Toolbox metal latch	480	225	230	1.6	Metal
STST74304-8	22" Toolbox metal latch	555	295	265	2.4	Metal

JUMBO



16"



19"

- Removable organizer on lid
- Metal latches
- Internal tray

SKU #	Description	Length (mm)	Width (mm)	Height (mm)	Weight (kg)	Latch
STST16028	16" Jumbo Metal Latch	400	250	185	1.1	Metal
STST19028	19" Jumbo Metal Latch	535	495	725	1.6	Metal

TOOL BOX



MADE IN USA
WITH GLOBAL MATERIALS™

- Built in padlock eye for small locks for secure storage of tools
- Nickel plated metal latches for durability
- Tote tray

SKU #	Description	Length (mm)	Width (mm)	Height (mm)	Weight (kg)	Latch
STST19005	19" Toolbox with Metal Latches	492.76	243.84	251.46	1.78	Metal
STST24113	24" Toolbox with Metal Latches	601.98	292.10	284.48	3.15	Metal

SERIES 2000



Metal Latch



Plastic Latch

- Organizer on lid
- Internal tray
- Metal latch

SKU #	Description	Length (mm)	Width (mm)	Height (mm)	Weight (kg)	Latch
STST13011	12.5" Series 2000 Plastic Latch	318	178	130	0.4	Plastic
STST16011	16" Series 2000 Plastic Latch	403	206	181	1.1	Plastic
STST19011	19" Series 2000 Plastic Latch	489	260	248	1.9	Plastic
STST13013	12.5" Series 2000 Metal Latch	318	178	130	0.5	Metal
STST16013	16" Series 2000 Metal Latch	403	206	181	1.1	Metal
STST19013	19" Series 2000 Metal Latch	489	260	248	1.9	Metal

ECON SERIES



- Organizer on lid with clear cover
- Internal tray

SKU #	Description	Length (mm)	Width (mm)	Height (mm)	Weight (kg)	Latch
1-71-948	13" Toolbox	320	150	135	0.5	Plastic
1-71-949	16" Toolbox	410	200	180	1.0	Plastic
1-71-950	19" Toolbox	480	230	230	1.6	Plastic
1-71-951	22" Toolbox	555	290	265	2.5	Plastic

PORTABLE TOTE TRAY



- Open access
- Tool rack

SKU #	Description	Length (mm)	Width (mm)	Height (mm)	Weight (kg)	Latch
STST41001	Portable Storage Tote Tray Blk	496	335	195	0.8	-



NEW 3-IN-1 TOOL ORGANIZER



- Made from polypropylene plastic
- Robust structure that provides security while transporting
- Movable dividers that provide specific configuration for smaller part and tools
- Central rigid tote that is perfect for hand tools

SKU #	Description	Length (mm)	Width (mm)	Height (mm)	Weight (kg)	Latch
STST1-71963	New 3-in-1 Tool Organizer	425	234	316	2.59	Plastic

SORT MASTER



- Ability to connect back to back
- Unique spacing design
- Removable divider plates



SKU #	Description	Length (mm)	Width (mm)	Height (mm)	Weight (kg)	Latch
STST14027	Sort Master	431	333	88	1.2	Plastic
STST14022	Sort Master Junior	375	292	67	0.7	Plastic
STST14021	Sort Master light	290	210	63	0.4	Plastic

8 COMPARTMENT PROFESSIONAL DEEP ORGANIZER



- 8 deep compartments for extra storage
- Lockable virtually unbreakable polycarbonate lid

SKU #	Description	Length (mm)	Width (mm)	Height (mm)	Weight (kg)	Latch
1-92-749	8 Compartment Professional Deep Organizer	419	337	108	1.67	Polycarbonate lid

ORGANIZER



- Removable divider plates
- Integrated handle



S / M



L

SKU #	Description	Length (mm)	Width (mm)	Height (mm)	Weight (kg)	Latch
STST73822-8	Small Organizer	320	265	50	0.4	Plastic
STST73823-8	Medium Organizer	380	300	60	0.7	Plastic
STST73824-8	Large Organizer	480	375	75	1.2	Plastic

CLEAR ORGANIZER



- Transparent lid and body
- Removable divider plates
- Rounded compartment edges make it simple to remove contents

SKU #	Description	Length (mm)	Width (mm)	Height (mm)	Weight (kg)	Latch
STST14009	9" Organizer Clear	210	115	35	0.1	Plastic
STST14014	14" Organizer Clear	357	229	48	0.5	Plastic



"UNIQUE LATCH DESIGN THAT CAN BE OPENED FROM BOTH SIDES, ENABLING EASY CONNECTING & DETACHING"

TOOL BAG STORAGE LINE



OPEN BULKY STRUCTURE DESIGN

Easy access to tools

600X600 DENIER FABRIC

Hardwearing, strong and durable

STRONG REINFORCED PLASTIC BASE

Protection from wet and damp surfaces

FREE STANDING OPEN MOUTH

Non collapsible enables easy access to tools at all times

MULTIPLE INTERNAL AND EXTERNAL POCKETS

Maximum organization potential

COVERED FRONT POCKET

Secure storage of small parts or personal items

PERSONAL POUCH



- Fully adjustable to different size of belts
- Large zippered pocket for secure storage of important items

SKU #	Description	Length (mm)	Width (mm)	Height (mm)	Weight (kg)
1-96-179	Personal Pouch	250	150	40	0.168

TOOL POUCH



- Multiple size pockets & loops; dedicated hammer storage
- Padded back

SKU #	Description	Material	Length (mm)	Width (mm)	Height (mm)	Weight (kg)	# of pockets inside
STST511324	Tool Pouch	600 denier polyester	235	130	330	0.3	11

9" POUCH



- Side Loop
- Front mesh pocket

SKU #	Description	Material	Length (mm)	Width (mm)	Height (mm)	Weight (kg)	# of pockets inside	# of pockets outside
STST509104	9" Pouch	600 denier polyester	240	160	110	0.2	1	3

TOOL APRON



- Multiple size pockets & loops; dedicated tape and hammer storage
- Adjustable belt and padded back

SKU #	Description	Material	Length (mm)	Width (mm)	Height (mm)	Weight (kg)	# of pockets inside
STST511304	Tool Apron	600 denier polyester	600	75	255	0.7	11

STANLEY® TOOL BELT



- Adjustable length

SKU #	Description	Material	Length (mm)	Width (mm)	Height (mm)	Weight (kg)
STST73830-8	Stanley® Tool Belt	600 denier polyester	1250	60	15	0.1

FATMAX™ MULTIFUNCTIONAL AND WORK VEST



- Numerous easy-access pockets and attachment options – often for easy transport of used tools
- Breathable – great wearing comfort even at high temperatures, no heat or humidity storage
- Safety through reflective inserts
- Robust-Double material on sensitive areas for protection from sharp objects
- Concealed inner pocket for safe storage of documents, etc

SKU #	Description	Length (mm)	Width (mm)	Height (mm)	Weight (kg)
FMST1-71181	Fatmax™ Multifunctional and Work Vest	580	10	47	1.32

12" SOFT SIDE TOOL BAG



- Multiple internal and external pockets
- Durable body material



SKU #	Description	Material	Length (mm)	Width (mm)	Height (mm)	Weight (kg)	# of pockets inside	# of pockets outside
STST512114	12" Soft Side Tool Bag	600 denier polyester	350	140	240	0.5	7	6

16" OPEN MOUTH BAG



- Strong reinforced plastic base
- Adjustable shoulder strap
- Free standing open mouth



SKU #	Description	Material	Length (mm)	Width (mm)	Height (mm)	Weight (kg)	# of pockets inside	# of pockets outside
STST516126	16" Open Mouth Bag	600 denier polyester	450	235	275	1.1	5	6

16" TOTE FABRIC BOTTOM



- Strong metal handle with comfortable grip
- Multiple internal and external pockets
- Adjustable shoulder strap



SKU #	Description	Material	Length (mm)	Width (mm)	Height (mm)	Weight (kg)	# of pockets inside	# of pockets outside
STST516114	16" Tote Fabric Bottom	600 denier polyester	410	230	325	1.7	11	11

14" TOOL BAG



- Heavy Duty 600 denier fabric
- Shoulder Strap
- Large rubber zipper

SKU #	Description	Length (mm)	Width (mm)	Height (mm)	Weight (kg)
STST1-73615	14" Tool Bag	360	21	255	0.9

STANLEY® BACKPACK



- Large inner compartment
- Large storage divider
- Back support system Mesh padding



SKU #	Description	Material	Length (mm)	Width (mm)	Height (mm)	Weight (kg)	# of pockets inside	# of pockets outside
STST515155	Stanley® Backpack	600 denier polyester	305	185	470	1.9	15	2

FATMAX® TOOLS BACKPACK ON WHEELS



- Strong reinforced plastic base with wheels
- Large inner compartment
- Large storage divider



SKU #	Description	Material	Length (mm)	Width (mm)	Height (mm)	Weight (kg)	# of pockets inside	# of pockets outside
FMST514196	Fatmax® Tools Backpack on Wheels	600 denier polyester	360	230	540	3.3	29	4

18" SOFT BAG WITH WHEELS



- Heavy duty 600 denier polyester that resists cuts and scratches
- Multiple internal and external pockets
- Drill and tools storage

SKU #	Description	Material	Length (mm)	Width (mm)	Height (mm)	Weight (kg)
1-97-515	18" soft bag with wheels	600 denier polyester	460	330	450	2.5

7-PIECE TOOLS SET



- 1pc Linesman Pliers : 7"
- 1pc Adjustable Wrench : 8"
- 1pc Cushion Grip : 6x100
- 1pc Cushion Grip : M6x100
- 1pc STANLEY Tape Rules : 3m
- 1pc Snap-Off Blade : 18mm
- 1pc Test Pen : 100-500V24

SKU #	Description	BOX/CTN
90-596N	7-pc Tools Set	1/36

18-PIECE TOOLS SET



- 1pc Precision Screwdriver Set
- 1pc Linesman Pliers : 8"
- 1pc Long Nose Pliers : 6"
- 1pc Adjustable Wrench : 8"
- 1pc Test Pen 100-500V AC : 150mm
- 1pc Snap-Off Knife : 9mm
- 1pc Cushion Grip : 3 x 100mm
- 1pc Cushion Grip : #0 x 100mm
- 1pc Cushion Grip : 6.5 x 150mm
- 1pc Cushion Grip : #2 x 150mm
- 1pc Solder Iron : 30W/220W
- 1pc STANLEY Tape Rules : 8m
- 1pc Metric Hex Key Set : 10pcs
- 1pc Wood Handle Nail Hammers : 130Z
- 1pc Mini Hacksaw : 8-3/4"
- 1pc Torch Light
- 1pc Pinch
- 1pc Scissor
- 1pc Nylon Bag

SKU #	Description	BOX/CTN
90-597	18-pc Tools Set	1/5

25 PCS DO-IT-ALL TOOLS SET



- 1 pc Wood Handle Nail Hammers 7oz
- 1 pc STANLEY Tape Rules 3meter 1
- 1 pc Knife
- 1 pc Metric Hex Key Set 10pcs
- 1 pc Linesman Pliers 8"
- 1 pc Long nose Pliers 6"
- 1 pc Adjustable wrench 8"
- 1 pc 6-way screwdriver
- 1 pc Digital Spark Test Pen
- 1 pc Torch Light
- 1 pc Waterproof Tools Bag

SKU #	Description	BOX/CTN
92-006	25 pcs Electrician's Tools Set	1/9

BLACK & DECKER® WORKMATE 301



- Durable steel construction
- Folds flat for storage
- Dual clamping cranks



SKU #	Description	Working Height	Folded Width	Folded Height	Folded Depth	Max Loading	Max Table Width
WM301-XJ	Workbench w/ Dual Clamping	760	630	890	130	160	341

BLACK & DECKER® WORKMATE 536



- Dual working heights
- Durable steel construction
- Folds flat for storage
- Dual clamping cranks



SKU #	Description	Working Height	Folded Width	Folded Height	Folded Depth	Max Loading	Max Table Width
WM536-XJ	Workbench w/ Dual Working Height	595 / 775	610	740	195	250	384

BLACK & DECKER® WORKMATE 1000



- One-handed quick clamp system
- Quick folding frame enables product free standing
- Folds flat for storage
- Dual clamping cranks



SKU #	Description	Working Height	Folded Width	Folded Height	Folded Depth	Max Loading	Max Table Width
WM1000-XJ	Workbench w/ Advance Quick Clamping System	803	670	1090	210	250	607

STANLEY®

CUTTING TOOLS



Snap-Off Knives

Utility Knives

Knife Blades

Handsaws

Hacksaws

Hacksaw Blades

Pipe Cutters

Snips



PRECISION EVERY TIME

STANLEY® manufactured its first utility knife back in 1935. We are the pioneer and innovator in this category. The **STANLEY®** cutting tool range is built to last, to provide excellent cutting performance and to have noteworthy safety and ergonomic features.



A MUST HAVE KNIFE FOR ALL TRADES

SNAP-OFF KNIVES

STANLEY® Snap-off Knives have high quality carbon steel blades that snap off in sections, providing a fresh and sharp cutting point to the user without the need to open up the knife. We bring innovation to snap-off knives by providing unique features that users have never experienced before.



**THICKER BLADES FOR
HEAVY DUTY TASKS**

UTILITY KNIVES

The **STANLEY®** range of advanced utility knives encompass a design that features more comfort, grip and handling than other brands. They have a thicker knife blade, simplifying efforts when it comes to tough cutting tasks. We provide a wide range of utility knives that offer different blade options and special applications.



Cardboard



Leather



Carpet



Vinyl

DO YOU KNOW...

Stanley's blades are very popular in the market. In fact, its state-of-the-art manufacturing facilities must pump out **20,000 miles** of blades each and every year to keep up with the demand.

FUN FACT

In the UK, Australia and New Zealand, any Utility Knife is simply known as a **STANLEY®** knife

KNIFE BLADES



Extensive tests and the use of advanced technology such as induction heat treated blade edge, make **STANLEY®** the leader in the category.

HANDSAWS



We are one of the largest hand saw manufacturers in the world. Producing over 4 million units a year, **STANLEY®** handsaws are at the top of their class. Its hard point teeth are heat treated to give the tool a much longer lifespan. Tests have proven that they can last up to five or six times longer than other brands.

HACKSAWS



STANLEY® hacksaws have excellent safety features, making them some of the safest and most reliable tools on the market. Its excellent blade tension mechanism system plays a role in ensuring that less accidents happen on the job, creating a safe and tension-free work environment.

PIPE CUTTER



STANLEY® offers an array of pipe cutters that are perfect additions to the tool box. Used for cutting metal and plastic pipes, there is an expectation for these cutters to be strong, durable and precise.

HACKSAW BLADES



Perfect for cutting metal or plastic piping, **STANLEY®** offers two different hacksaw blades with materials include High Speed Steel (HSS) and Bi-Metal. Bi-Metal hacksaw blades are made from a material that combines the segregated section of HSS and carbon steel.

SNIPS



STANLEY® Snips have undergone various durability tests to prove the tools' hardness, cutting load, cutting length, cutting life, corrosion and solvency levels. Every test conducted exceeded ANSI standards, making these tools some of the best in the world.

SNAP-OFF KNIVES & BLADES OVERVIEW

PROFILE	CASE MATERIAL	LOCKING SYSTEM	SNAP-OFF BLADE		
			9mm	18mm	25mm
Professional Snap-Off Knife	Metal + ABS Metal + ABS & TPR	Auto Lock / Dial Lock	●	●	
QuickPoint™ Snap-Off Knife	ABS	Auto Lock	●	●	
Dynagrip™ Snap-Off Knife	Metal + ABS & TPR	Dial Lock	●	●	●
18mm Cartridge Blade Knife	Metal + Plastic	Auto Lock		●	
18mm Snap-Off Blade Knife	Metal + Plastic	Auto Lock		●	
Professional Interlock™ Knife	Metal	Captive Wheel Lock		●	

UTILITY KNIVES & BLADES OVERVIEW

PROFILE	CASE MATERIAL	Utility Knife Blades				
		STHT11921-8 Heavy Duty	11-987 Safe Round-Point	0-11-983 Large Hook Blade	0-11-700 FatMax® Utility Blade	
Fixed Blade	STANLEY® Classic 199®	Metal	●	●	●	●
	STANLEY® FatMax®	Metal	●	●	●	●
Retractable	STANLEY® Classic 99®	Metal	●	●	●	●
	Retractable Utility Knife	Plastic	●	●	●	●
	Dynagrip™ Retractable Utility	Metal + TPR	●	●	●	●
	Ergonomic All-Metal Retractable	Metal	●	●	●	●
	STANLEY® FatMax® Retractable	Metal+TPR	●	●	●	●
Safety	Self-Retracting Utility Knife	Metal	●	●	●	●

STANLEY®

18mm Snap-off Knife

KNIFE SKU	DESCRIPTION	BLADE SKU
STHT10276-8	18mm Snap-off Knife	STHT11147-8*

*Fits STANLEY® Double-Point, Quick-Point™ and most other 18mm snap-off blade.



ERGONOMIC+ ANTI SLIP DESIGN

Enables firm and comfortable holding position, also providing excellent grip control

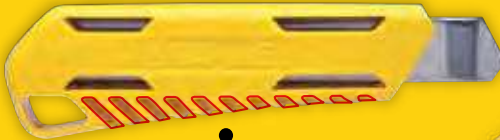

HANG HOLE
for easy storage

AUTO LOCK SLIDER

automatically holds blade in a fixed position to prevent blades from being pulled out and pushed in

2x Cutting Points

Equipped with 18mm
DOUBLE POINTS BLADE



Long & Smooth Cut

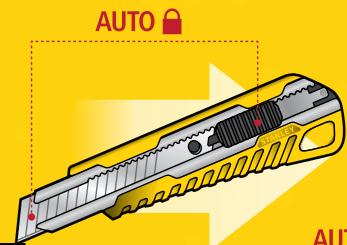

AUTO 

AUTO 

Hard Cut

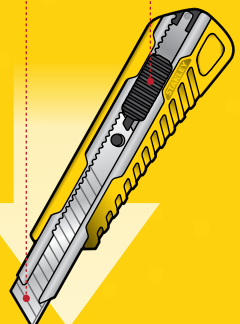

MADE IN  **UK**
WITH GLOBAL MATERIALS™

STANLEY® knives are equipped with Stanley's high quality blades made by Stanley's UK plant where more than **32,000 KMs** of blades are made annually. These blades are made with intensive testing for quality.

PROFESSIONAL 18MM SNAP-OFF KNIFE



- Ergonomic design of thumb pad and neck down create comfortable grip and control
- Bi-material TPR handle with soft grip or full ABS version for durability
- Fits application needs from light to heavy duty and specially designed to improve cutting performance
- Dial lock or auto slide lock for convenience and safety
- Removable blade snapper in the knife cap
- Storage of spare blades

SKU #	Description	Blade width (mm)	Length (mm)	Locking Mechanism	No. of Blade	Box Qty
STHT10265-8	18mm ABS Auto Lock Snap-Off Knife	18	172	Auto Slide Lock	3	12
STHT10266-8	18mm TPR Auto Lock Snap-Off Knife	18	172	Auto Slide Lock	3	12
STHT10268-8	18mm TPR Dial Lock Snap-Off Knife	18	172	Screw Dial Lock	3	12

PROFESSIONAL 9MM SNAP-OFF KNIFE



- Ergonomic design of thumb pad and neck down create comfortable grip and control
- Bi-material TPR handle with soft grip or full ABS version for durability
- Fits application needs from light to heavy duty and specially designed to improve cutting performance
- Removable blade snapper in the knife cap

SKU #	Description	Blade width (mm)	Length (mm)	Locking Mechanism	No. of Blade	Box Qty
STHT10264-8	9mm TPR Auto Lock Snap-Off Knife	9	140	Auto Slide Lock	1	12

QUICK POINT™ SNAP-OFF KNIFE



- Light-duty, auto lock knife with Quick Point™ blades
- Durable and compact ABS body for simple storage and handling
- Blade sections snap off providing fresh and sharp cutting points
- Removable blade snapper included in the knife cap

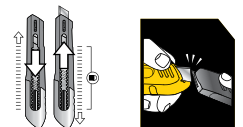

SKU #	Description	Blade width (mm)	Length (mm)	Locking Mechanism	No. of Blade	Box Qty
STHT10150-8	9mm QuickPoint™ Snap-Off Knife	9	130	Auto Slide Lock	1	6
STHT10151-8	18mm QuickPoint™ Snap-Off Knife	18	156	Auto Slide Lock	1	6

STANLEY

DYNAGRIP™
SNAP-OFF KNIFE



DYNAGRIP™ SERIES

adding the new soft grip on top of the durable case

ERGONOMICALLY DESIGNED HANDLE

Bi-material with soft TPR providing comfort with performance

RIGID STAINLESS STEEL BARREL

corrosion resistant and provides smooth action



DIAL LOCK

with security and firm blade control for heavy-duty cutting



HIGH PERFORMANCE BLADE
MADE BY STANLEY® with quality and great cutting life



SKU #	Description	Blade width (mm)	Length (mm)	Locking Mechanism	No. of Blade	Box Qty
STHT10409-8	Dynagrip™ Snap-Off Knife - 9mm	9	133	Screw Dial Lock	1	12
STHT10418-8	Dynagrip™ Snap-Off Knife - 18mm	18	165	Screw Dial Lock	1	6
STHT10425-8	Dynagrip™ Snap-Off Knife - 25mm	25	178	Screw Dial Lock	1	6

18MM CARTRIDGE BLADE KNIFE



- Auto reloading cartridge with 6 blades storage provides time saving and improves work efficiency
- Bi-material ABS + TPR body gives extra comfort and grip control
- Blade clamp enables better blade control and extra security
- Auto slide lock for convenience and safety



SKU #	Description	Blade width (mm)	Length (mm)	Locking Mechanism	No. of Blade	Box Qty
0-10-480	18mm Snap-Off Cartridge Blade Knife	18	172	Auto Slide Lock	6	6

18MM SNAP-OFF BLADE KNIFE



- Full ABS body is lightweight and durable
- Ergonomic design offers a comfortable grip and better handling
- Rigid stainless steel barrel provides smooth action and is corrosion resistant
- Auto slide lock for convenience and safety



SKU #	Description	Blade width (mm)	Length (mm)	Locking Mechanism	No. of Blade	Box Qty
10-280-0	18mm Snap-Off Blade Knife	18	174	Auto Slide Lock	2	6

PROFESSIONAL INTERLOCK™ KNIFE

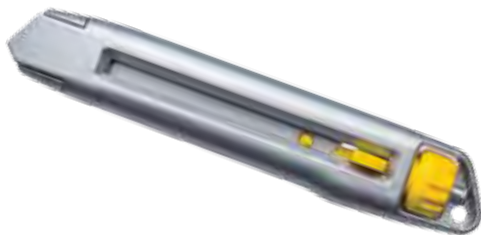

- Ideal for heavy duty cutting
- Metal construction for long life
- Ability to open and clean the knife
- Captive wheel lock for heavy duty clamping



SKU #	Description	Blade width (mm)	Length (mm)	Locking Mechanism	No. of Blade	Box Qty
0-10-018	18mm Interlock™ Knife	18	210	Auto Slide Lock	1	12

CLASSIC 199® FIXED BLADE UTILITY KNIFE



- Nose overlaps at top and bottom for added strength
- Cast metal textured handle designed for long and tough use
- Works with all STANLEY® replacement utility blades

SKU #	Description	Length (mm)	Width (mm)	Blade Thickness (mm)	No. of Blade	Box Qty
STHT10209-8	Classic 199® Fixed Blade Utility	136.8	20.2	0.61	3	6

STANLEY CLASSIC 99®



- The one and only Original STANLEY®
- Interlock® nose firmly secures the blade into the knife

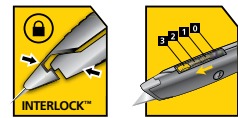

SKU #	Description	Length (mm)	Width (mm)	Blade Thickness (mm)	No. of Blade	Box Qty
10-099	Classic 99® Retractable Utility	152	18.5	0.65	3	6

RETRACTABLE UTILITY KNIFE



- Lightweight, economical utility knife
- Three-positioned retractable blade
- Interlocking overlap nose secures blade safely between knife halves

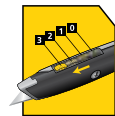

SKU #	Description	Length (mm)	Width (mm)	Blade Thickness (mm)	No. of Blade	Box Qty
STHT10175-8	Retractable Utility Knife	154.0	18.7	0.65	1	6

DYNAGRIP™ RETRACTABLE UTILITY



- Dynagrip™ surface for comfort, even in extreme temperatures
- Slip-resistant grip helps prevent slipping, even on angled surfaces
- Patented interlocking nose secures blade



SKU #	Description	Length (mm)	Width (mm)	Blade Thickness (mm)	No. of Blade	Box Qty
STHT10779-8	Dynagrip™ Retractable Utility	150	22.5	0.65	1	6

SELF-RETRACTING UTILITY KNIFE



- Spring-loaded blade retracts into knife automatically when pressure on slide button is released
- Interlocking nose secures blade safely between knife halves
- Orange colored for high visibility and safety



SKU #	Description	Length (mm)	Width (mm)	Blade Thickness (mm)	No. of Blade	Box Qty
STHT10189-8	Self-Retracting Utility Knife	150.3	20.2	0.65	1	6

BASIC SNAP-OFF KNIFE



- Lightweight and economical snap-off blade knife
- Works with most light-weight applications
- Tips in use can be removed with the snapper at the end-cap of the knife
- Pocket clip included on the 9mm (10-131) Snap-Off Knife

SKU #	Description	Blade Width	O/A Length		Box/CTN
			mm	Inches	
10-131-S	9mm snap-off knife	9mm	137	5-3/8"	6/864
10-143-S	18mm snap-off knife	18mm	152	6"	6/432

PLASTIC RETRACTABLE KNIFE



- Versatile plastic body knife
- Great for a variety of light-duty cutting and trimming jobs
- Unique patented snap closure allows quick blade changes
- No need for a screwdriver
- Five position retractable blade
- Stainless steel blade carrier
- Furnished with one 11-921 heavy-duty utility blade
- For light-duty use only

SKU #	Color #	Handle Length	Number of Blades	Box/CTN
10-065	Yellow	152mm, 6"	1	6/36

18MM SNAP-OFF CARTRIDGE KNIFE



- This 18mm Snap-Off Cartridge Knife has a 6-5/8" handle length
- Features a blade cartridge which rapidly and automatically slides new blade into position after old blade is removed
- Ergonomically designed for comfort and cutting power
- The smooth slider mechanism features an audible click-stop and is self locking for greater blade security
- Hang hole for storage or lanyard
- Blade capacity of six heavy-duty blades or five extra heavy-duty blades
- Supplied with three 11-301 heavy-duty blades (equals 24 points)

SKU #	Blade Width	O/A Length		Box/CTN
	mm	mm	Inches	
10-380-0	18	172	6-3/4" Handle 6-5/8"	6/36

FATMAX® RETRACTABLE UTILITY KNIFE



- Adjustable thumb-dial locking wheel holds blade in place and prevents shifting
- Swivels open for quick blade change – no tools required
- Rear blade storage for seven blades
- Ergonomically designed rubber grip fits comfortably in hand
- Lightweight, durable body

SKU #	Length		BOX /CTN
	mm	inches	
10-777	165	6.5"	6/36



CLASSIC 1992® HEAVY-DUTY UTILITY BLADE



- Heavy-duty blade, ideal for carpet and vinyl
- Replacement blade for 10-099, 10-175, 10-777, 10-779 & 10-804

SKU#	#of blades	Length mm	Blade Width		Blade Thickness	Blades Pack Details	Box/CTN
			mm	inches			
11-921H	100	62	19	3/4"	0.65mm	10 Dispensers of 10pcs	1/24
11-921T	10	62	19	3/4"	0.65mm	10 per Dispensers	12/72

QUICK-POINT™ BLADE



- Fits most 9mm snap-off blade knives



- Fits Stanley 18mm snap-off blade knives and most other 18mm Snap-Off blade knives



- Fits Stanley 25mm snap-off blade knives and most other 25mm Snap-Off blade knives



9mm



18mm



25mm

SKU #	Description	Width (mm)	Thickness (mm)	Package Detail	Points	No. of Pieces	Box Qty
STHT11300-8	3-Pack Quick-Point™ Blade -9mm	9	0.43	–	13	3	10
STHT11300-8Q	10-Pack Quick-Point™ Blade -9mm	9	0.43	Dispenser	13	10	10
STHT11301-8	3-Pack Quick-Point™ Blade -18mm	18	0.50	–	8	3	10
STHT11301-8Q	10-Pack Quick-Point™ Blade -18mm	18	0.50	Dispenser	8	10	10
11-301T	10 x10-Pack Quick-Point™ Blade -18mm	18	0.50	Dispenser	8	100	–
STHT11325-8	3-Pack Super Heavy Duty Blade -25mm	25	0.70	–	7	3	6
STHT11325-8Q	10-Pack Super Heavy Duty Blade -25mm	25	0.70	Dispenser	7	10	4

DOUBLE CUTTING POINTS BLADE



- Replacement blade with 15 cutting points for better cost efficiency per point
- Fits Stanley 18mm snap-off blade knives and most other 18mm snap-off blade knives



SKU #	Description	Width (mm)	Thickness (mm)	Package Detail	Points	No. of Pieces	Box Qty
STHT11147-8Q	10-Pack Double Cutting Points Blade - 18mm	18	0.50	Dispenser	15	10	10

HEAVY DUTY UTILITY KNIFE BLADE



- Engineered for general-purpose cutting
- Precision-honed edge for consistent and long cutting life
- Fits most standard utility knives

SKU #	Description	Thickness (mm)	Package Detail	No. of Pieces	Box Qty
STHT11921-8	5-Pack HeavyDuty Utility Knife Blade	0.61	–	5	10
STHT11921-8Q	10-Pack HeavyDuty UtilityKnife Blade	0.61	Dispenser	10	7

SAFE ROUND-POINT UTILITY BLADE



- Rounded edge helps reduce risk of accidental cuts
- Helps prevent damage to carton contents when opening boxes
- Fits most standard utility knives

SKU #	Description	Thickness (mm)	Package Detail	No. of Pieces	Box Qty
11-987	5-Pack Carton Round-Point Utility Blade	0.61	–	5	20

LARGE HOOK BLADE



- With deeper hook for cutting thicker materials
- Fits most standard utility knives

SKU #	Description	Thickness (mm)	Package Detail	No. of Pieces	Box Qty
0-11-983	5-Pack 1996™ Large Hook Blade	0.61	–	5	20

STEEL FRAME HACKSAW



- Positive locking mechanism
- Two blade position 90°/55°
- Aluminium handle - 12" blades

SKU#	Length		Blade Size		Box/CTN
	mm	inches	mm	inches	
15-166	450	17-3/4"	305	12"	6/36

10" V 12" ADJUSTABLE BLADE RUBBER GRIP HACKSAW



- Easy adjustment of frame for 10" and 12" blades
- Rigid steel frame with molded cushion grip
- D-shape guard helps protect hands and knuckles
- Blade Length 10" / 254mm or 12"/305mm
- Throat Depth 3-7/8" / 98mm

SKU#	Length		Blade Size		Box/CTN
	mm	inches	mm	inches	
15-265-5	98	3-7/8"	305	12"	6/6

10" V 12" ADJUSTABLE BLADE HACKSAW



- Rugged plated steel frame
- Fits 10" and 12" blades
- Comfort pistol-grip handle
- Blade Length 10"/254mm or 12"/305mm
- Throat Depth 2-3/4" / 70mm

SKU#	Length		Blade Size		Box/CTN
	mm	inches	mm	inches	
15-565-5	70	2-3/4"	254/300	10"/12"	6/6

WOOD HANDLE SAW



- Machine set and sharpened teeth for accurate cutting
- High carbon steel blade hardened and tempered for sharpness and durability
- Comes with full length sleeve

SKU#	Contents	Tooth Pattern	Box/CTN
20-502	18"	Crosscut / 7TPI	12/24
20-503	20"	Crosscut / 7TPI	12/48

PLASTIC HANDLE SAW



- Handle offers a square/mitre feature with 45° and 90° angles
- Contoured sturdy handle designed for comfort and control
- Full length protective sleeve

SKU #	Blade Length	Tooth Pattern	Box/CTN
20-081	20"	Crosscut / 6TPI	12/48

LUCTADOR HANDSAW



- Handle offers a square/mitre feature with 45 degree and 90 degree angles
- Contoured sturdy handle designed for comfort and control
- Full length protective sleeve
- Cross cut

SKU #	Description	Blade Length (in.)	Blade Length (mm)	TPI
20-082-23	Saw Crosscut 22" X 6T/7P	22"	558	6
20-083-23	Saw Crosscut 24" X 6T/7P	24"	600	6
20-004-23	Saw Crosscut 18" X 7T/8P	18"	450	7
20-005-23	Saw Crosscut 20" X 7T/8P	20"	500	7
20-006-23	Saw Crosscut 22" X 7T/8P	22"	558	7
20-007-23	Saw Crosscut 24" X 7T/8P	24"	600	7

FATMAX® JAB SAW



- SharpTooth™ Technology cuts on push and pull strokes and is up to 50% faster than traditional tooth designs
- Sharpened tip punches through drywall with ease
- Hardened, tempered blade for increased cutting life
- Excellent for wood, plastic, and drywall
- Slip-resistant handle is designed for strength and durability

SKU #	Description	Blade Length (in.)	Blade Length (mm)	TPI	Box Qty
20-556	6" FatMax® Jab saw	6"	152	9	6

FATMAX® MINI FLUSH CUT PULL SAW



- Flexible blade for flush cutting plugs and dowels
- 23-point tooth geometry cuts quickly and cleanly on the pull stroke
- Designed for trimming through tenon or lap joints
- Double sided blade for convenient cutting from the left or the right
- Ergonomically designed cushion grip handle for comfort

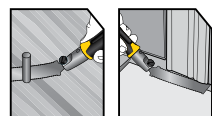

SKU #	Description	Blade Length (in.)	Blade Length (mm)	TPI	Box Qty
20-331	FatMax® Mini Flush Cut Pull Saw	4-3/4"	120	23	4

FLUSH CUT PULL SAW



- Flexible blade for flush and finish cuts
- Quick-change blade to handle assembly
- Thin blade for cutting accuracy and clean finish
- Ergonomically designed cushion grip handle for comfort

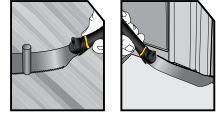

SKU #	Description	Blade Length (in.)	Blade Length (mm)	TPI	Box Qty
20-500	Flush Cut Pull Saw	9"	229	15	4

12" BASIC HACKSAW



- Robust, all-metal frame for durability
- Full grip handle helps protect knuckles
- Compact frame for comfort and control
- Large tensioning knob for ease of use
- 90° and 180° adjustable blade angles allowing flush cuts

SKU #	Description	Blade Length (in.)	Blade Length (mm)	TPI	Box Qty
STHT20138	12" Basic Hacksaw	12"	305	24	6

MINI-HACK™ UTILITY SAW



- 15809 - Durable solid aluminum construction
- 20807 – Durable solid plastic construction
- Ideal for hard-to-reach places
- Handle covers blade to help protect user's hands

SKU #	Description	Blade Length (in.)	Blade Length (mm)	TPI	Box Qty
STHT15809-8	10" Metal Mini-Hack™ Utility Saw	10"	250	24	6
STHT20807-8	10" Mini-Hack™ Utility Saw	10"	250	24	6

COPING SAW



- Hardened, tempered provides clean, controlled cutting action
- 4 blades included
- Light weight wooden handle

SKU #	Description	Blade Length (in.)	Blade Length (mm)	Frame Depth (mm)	TPI	Box Qty
STHT15104-8	Coping Saw 120mm_4.75" Depth (4 blades)	6-1/2"	165	120	15	-
STHT15106-8	Coping Saw 170mm_6.75" Depth (4 blades)	6-1/2"	165	120	15	-

12" TUBULAR HIGH-TENSION HACKSAW



- High tension hacksaw frame
- Holds blades at up to 300 Lbs (136Kg)
- Rubber handles and large comfortable tensioning knob
- Allows positioning of the blade at 45° for more versatility
- 120mm (4-3/4") throat depth
- Storage of hacksaw blade (8 PCS) in the frame
- Durable and robust tubular metal frame
- Long reach cutting

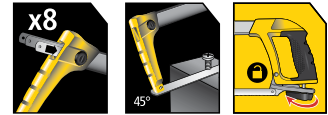

SKU #	Description	Blade Length (in.)	Blade Length (mm)	TPI
STHT20140-8	12" Tubular High-Tension Hacksaw	12"	300	24

12" PRO FIXED HACKSAW



- Ergonomic handle with pattern for comfort, better grip and control
- Closed handle for hand protection
- Allows positions of the blade at 90° for more versatility
- Front thumb grip with patented texture for improved control and grip
- Tension screw with pattern for easy blade tensioning
- Resistant light weight and lean frame design allows access to difficult hard-to-reach areas

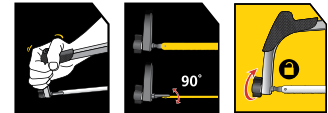

SKU #	Description	Blade Length (in.)	Blade Length (mm)	TPI	Box Qty
STHT20064-8	12" Pro Fixed Hacksaw	12"	300	24	6

12" FIXED HACKSAW



- Comfortable full handle with patented pattern for better grip and control
- Full grip protects knuckles
- Sturdy all steel painted frame
- 101.6mm (4") throat depth



SKU #	Description	Blade Length (in.)	Blade Length (mm)	TPI
STHT20206-8	12" Fixed hacksaw	12"	300	24

PRO ADJUSTABLE HACKSAW



- Adjustable to 8", 10" and 12" blades
- Closed handle for strength and control
- Rubber covered handle for greater control and better grip
- Allows positioning of the blade at 90° for more versatility
- 101.6mm (4") throat depth

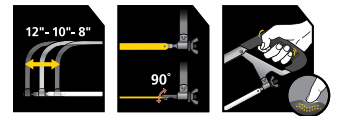

SKU #	Description	Blade Length (in.)	Blade Length (mm)	TPI
STHT15555-8	Pro Adjustable Hacksaw	12"	300	24

ADJUSTABLE HACKSAW



- Adjustable to 8", 10" and 12" blades
- Comfort pistol-grip handle with patented pattern for better grip and control
- Allows positioning of the blade at 90° for more versatility
- 101.6mm (4") throat depth

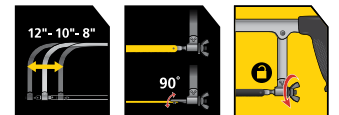

SKU #	Description	Blade Length (in.)	Blade Length (mm)	TPI
STHT15200-8	Adjustable Hacksaw	12"	300	24

BI-METAL HACKSAW BLADE



- Combines the flexibility of carbon steel backs with the cutting performance of a high-speed steel cutting edge
- Cuts most metals including unhardened tool steel and stainless-steel

SKU #	Description	TPI	Length (in.)	Length (mm)	No. of Blade
STHT20297-8	Bi-Metal Hacksaw Blade 18Tx12"(x100)	18	12"	300	100
STHT20298-8	Bi-Metal Hacksaw Blade 24Tx12"(x100)	24	12"	300	100
STHT20299-8	Bi-Metal Hacksaw Blade 32Tx12"(x100)	32	12"	300	10

BI-METAL HACKSAW BLADE



- Combines the flexibility of carbon steel backs with the cutting performance of a high-speed steel cutting edge
- Cuts most metals including unhardened tool steel and stainless-steel

SKU #	Description	TPI	Length (in.)	Length (mm)	No. of Blade
20-175	Bi-Metal Hacksaw Blade 18Tx12"(x100)	18	12"	300	100
20-176	Bi-Metal Hacksaw Blade 24Tx12"(x100)	24	12"	300	100
20-177	Bi-Metal Hacksaw Blade 32Tx12"(x100)	32	12"	300	100
95-297	Bi-Metal Hacksaw Blade 18Tx12"(x10)	18	12"	300	10
95-298	Bi-Metal Hacksaw Blade 24Tx12"(x10)	24	12"	300	10
95-299	Bi-Metal Hacksaw Blade 32Tx12"(x10)	32	12"	300	10

HIGH SPEED STEEL HACKSAW BLADE



- Ground tooth design for improved cutting performance versus traditional hacksaw blades
- Can be used on most metals including unhardened tool steel and stainless-steel

SKU #	Description	TPI	Length (in.)	Length (mm)	No. of Blade
15-988	HSS Hacksaw Blade 18Tx12"(x100)	18	12"	300	100
15-982	HSS Hacksaw Blade 32Tx12"(x100)	32	12"	300	100
95-294	HSS Hacksaw Blade 18Tx12"(x10)	18	12"	300	10
95-295	HSS Hacksaw Blade 24Tx12"(x10)	24	12"	300	10
95-296	HSS Hacksaw Blade 32Tx12"(x10)	32	12"	300	10

TUBING CUTTER



- Tubing cutters for cutting copper/plastic tubing

SKU #	Description	O/A Length (in.)	O/A Length (mm)	Box Qty
93-020	Tubing Cutter	1/8" - 1 1/8"	3 - 28	10
93-021	Tubing Cutter	1/8" - 1 1/4"	3 - 31	10
93-028	Tubing Cutter	1/4" - 2 1/2"	6 - 64	6

MINI TUBING CUTTER



- Tubing cutters for cutting copper/plastic tubing

SKU #	Description	O/A Length (in.)	O/A Length (mm)	Box Qty
93-033	MINI Tubing Cutter	1/8" - 3/4"	3 - 16	12

PVC PIPE CUTTER



- Heavy duty PVC pipe cutter
- Stainless steel blades
- Heat treated for durability

SKU #	Description	O/A Length (in.)	O/A Length (mm)	Box Qty
14-442	PVC Pipe Cutter	1" - 5/8"	42	10

BOLT CUTTER



- A range of bolt cutters in most popular sizes
- Cutter blades are of chrome molybdenum tempered steel with cutting jaws tempered HRC 60° (FBS std)
- Special heat treatment give blades extra hardness and durability



SKU#	Length		Max Cutting Load (kg)	Box/CTN
	mm	inches		
14-308-S	203	8"	36	6/48
14-312-S	305	12"	46	6/24
14-314-S	355	14"	54	6/24
14-318-S	457	18"	65	6/12
14-324-S	609	24"	61	2/6
14-330-S	762	30"	84	1/4
14-336-S	914	36"	104	1/4

PRUNING SHEARS



- Blades of precision steel
- Cuts up to 18mm / 3/4" thickness
- Padded handle for comfort and reduced hand fatigue
- Safety lock feature

SKU#	O / A Length		Type	Box/CTN
	mm	inches		
14-302	200	8"	Bypass	10/60
14-303	200	8"	Anvil	10/60

WIRE STRIPPER



- Convenient hole for looping or bending wire
- Ideal for cutting, stripping speaker wire & appliance cords
- Slide adjust for various gauge wire

SKU#	O / A Length		Box/CTN
	mm	inches	
84-214	130	5-1/4"	15/150

CABLE CUTTER



- Designed for electric cable, copper, aluminum, etc
- Notched jaw holds & cuts cables in a clean & sharp way

SKU#	Type	Length	Max Cutting (mm ²)	Box/CTN
		inches		
84-258	10" Cable Cutter	10"	60	6/36
84-629	12" Cable Cutter	12"	125	6/24
84-630	21" Cable Cutter	21"	250	1/10
84-632	32" Cable Cutter	32"	500	1/5

AVIATION SNIPS



- Cuts up to 18 gauge (1.2mm) cold-rolled steel or 23 gauge (0.7mm) stainless-steel
- Forged chrome molybdenum steel cutting blades for strength, durability and long cutting life
- Serrated cutting blades provides a sturdy bite and helps prevent material from slipping during use
- Latch design allows for a quick single handed operation
- Adjustment-free fasteners prevent loosening of the blades
- Color-coded, slip-resistant bi-material grip for comfort and control
- Meets or exceeds ANSI standards



SKU #	Description	Length (in.)	Length (mm)	Box Qty
14-562	Aviation Snips - Left Cut	10"	250	6
14-563	Aviation Snips - Straight Cut	10"	250	6
14-564	Aviation Snips - Right Cut	10"	250	6

AVIATION SNIPS - STRAIGHT LONG



- Extended cutting blade allows for a longer distance per cut than standard length blades
- Cuts up to 18 gauge (1.2mm) cold-rolled steel or 23 gauge (0.7mm) stainless-steel
- Forged chrome molybdenum steel cutting blades for strength, durability and long cutting life
- Serrated cutting blades provides a sturdy bite and helps prevent material from slipping during use
- Latch design allows for a quick single handed operation
- Adjustment-free fasteners prevent loosening of the blades
- Color-coded, slip-resistant bi-material grip for comfort and control
- Meets or exceeds ANSI standards



SKU #	Description	Length (in.)	Length (mm)	Box Qty
14-566	Aviation Snips - Straight Long Blade	11"	275	6

TIN SNIPS



- Cuts up to 20 gauge (0.91mm) cold-rolled steel or 23 gauge (0.72mm) stainless-steel
- Durable fully-polished steel blades are forged to stay sharp for long cutting life
- Adjustment-free fastener prevents loosening of the blades
- Slip-resistant double cushion grip for comfort
- Meets or exceeds ANSI standards



SKU #	Description	Length (in.)	Length (mm)	Cold-Rolled Steel Up To	Stainless Steel Up To	Box Qty
STHT14569-8	7" Stanley® All-Purpose Straight Pattern Snips	7"	180	25ga/0.57mm	28ga/0.38mm	6
STHT14556-8	10" Stanley® All-Purpose Straight Pattern Snips	10"	250	22ga/0.78mm	26ga/0.45mm	6
STHT14558-8	12" Stanley® All-Purpose Straight Pattern Snips	12"	300	20ga/0.91mm	23ga/0.72mm	6

ENGLISH SNIPS



- Serrated cutting edges to prevent slippage when cutting
- Forged alloy steel for long life
- Single pivot action & soft grip for comfort
- Interlocking joint assembly for smooth cutting
- Heat treated high chrome steel forging for long life and durability

SKU #	Description	Length (in.)	Length (mm)	Box Qty
14-163	Tinsnips w/o Spring, 200mm - 8"	8"	200	6
14-164	Tinsnips w/o Spring, 250mm - 10"	10"	250	6
14-165	Tinsnips w/o Spring, 300mm - 12"	12"	300	6
14-166	Tinsnips w/o Spring, 350mm - 14"	14"	350	6

HEDGE SHEARS



- Shock absorbing bumpers on the handle reduce tensions during cuttings
- Ergonomic non-slip handle grips provide comfort for your hands
- Top coated with non-stick material makes it easy to clean

SKU #	Description	Length (mm)	Width (mm)	Blade Length (mm)	Weight (Kg)	CTN Qty
STHT74995-8	Hedge Shears	590	250	200	1.02	12

STANLEY®

CLAMPING TOOLS



Pliers Locking Pliers

Pliers Sets

Vde Pliers

Pipe Pliers

Adjustable Wrench



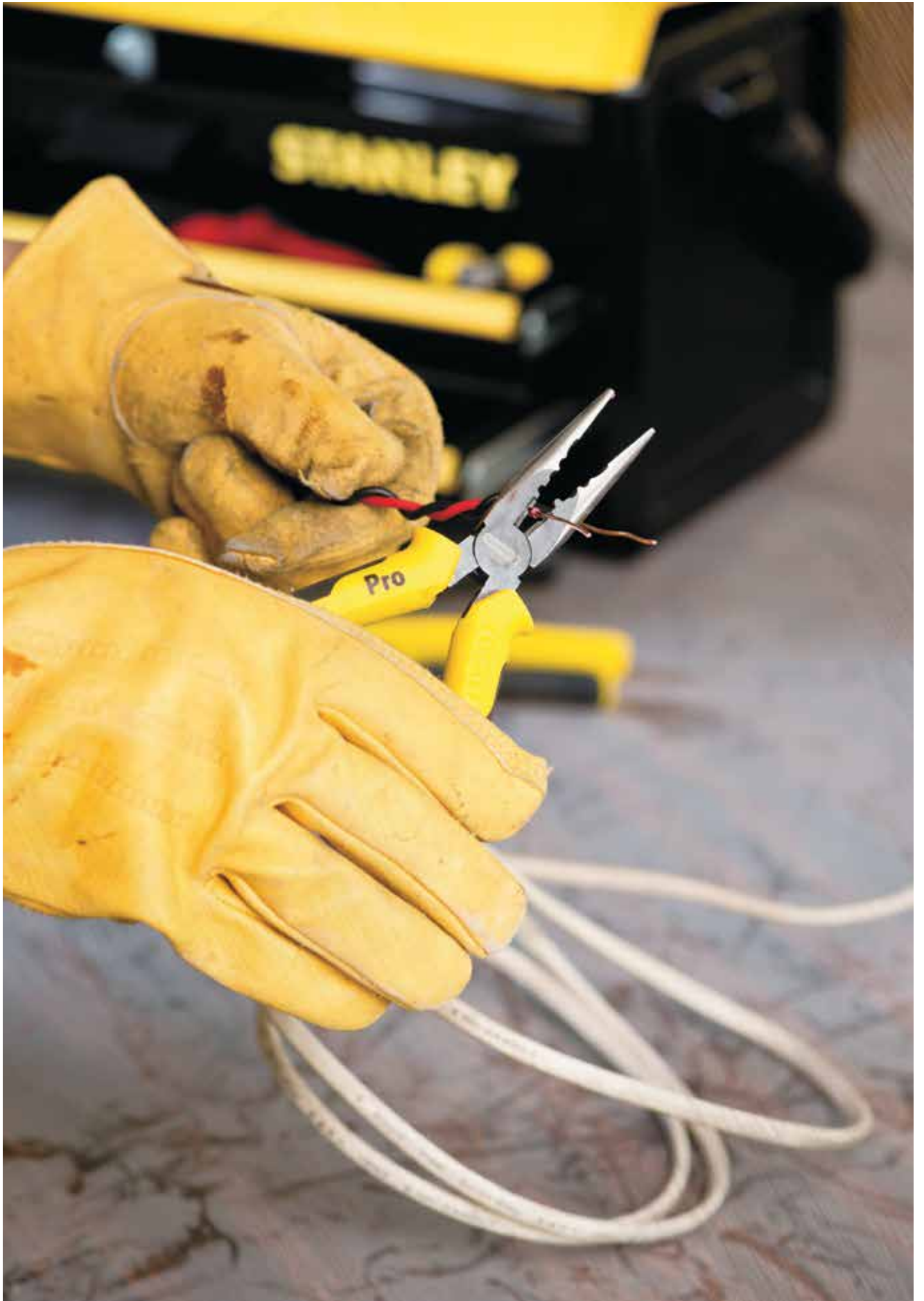

PERFECTION IN ACTION

Extensive quality testing is done on every clamping tool design, ensuring that daily performance exceeds industry standards. This comprehensive range allows for varied utility.

THE COMPREHENSIVE RANGE OF PLIERS

Whatever the task is, there is a **STANLEY®** pliers to help. Manufactured from quality steel, the range of pliers are built for high performance in any situation.

The range of options include linesman, combination, diagonal cutter, long nose, bent nose, wire stripper, slip joint, groove joint, and locking pliers.

PLIERS Available as:

Linesman, combination, long nose, bent nose, wire stripper, slip joint & groove joint variants



LOCKING PLIERS Available as:

Curved jaw, Straight jaw, Long nose, Welding, Sheet metal or 'C' clamp variants



LINESMAN



LONG NOSE



SLIP JOINT



DIAGONAL CUTTER



WIRE STRIPPERS



CURVED JAW



ANSI
American National Standards Institute

VDE PLIERS

STANLEY® is proud to be one of the market leaders in providing VDE solutions. Tested and proven, these tools either meet or exceed industry standards and can ensure safety when working with live equipment up to 1000VAC or 1500VDC.



PIPE PLIERS

The pipe pliers by **STANLEY®** boast a solid cast iron body and jaw forged with chrome molybdenum steel. Tough materials are used to ensure that the entire range provides users with great performance and durability.



ADJUSTABLE WRENCH

Every wrench produced by **STANLEY®** exceeds ANSI standards. Adjustable jaw design allows tool to grip many fastener sizes. Knurl adjusting mechanism is available for quick and precise adjustments.



PLIERS RANGE OVERVIEW

TYPE	SIZE								
	4"	5"	6"	7"	8"	9"	9-1/2"	10"	12"
Long Nose	•	•	•		•				
Linesman			•	•	•	•			
Diagonal Cutting		•	•	•	•				
Bent Nose		•	•		•				
End Nipper	•		•		•				
Slip Joint			•		•				
Groove Joint					•			•	•
Flat Nose	•		•						
Round Nose			•						
Neddele Nose		•							
Wire Stripper			•						
Combination			•						
High Leverage Cable Cutting							•		
Fence								•	
Circlip				•					

LOCKING PLIERS RANGE OVERVIEW

TYPE	SIZE						
	6-1/2"	7"	8"	9"	9-1/2"	10"	11"
Curved Jaw		•				•	
Straight Jaw		•				•	
Long Nose	•				•		
Welding				•			
Sheet Metal			•				
C Clamps							•

STANLEY[®]

DYNAGRIP[™] PLIERS

FORGED CARBON STEEL JAWS

fully heat treated for optimum performance and durability

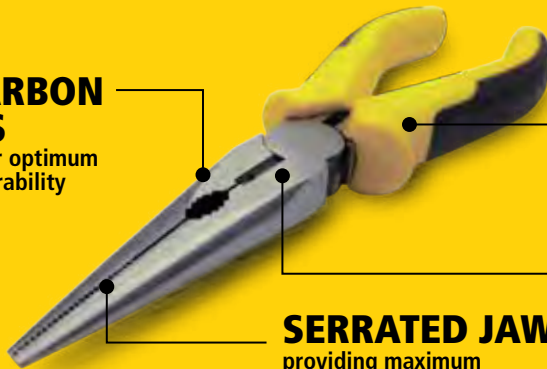

BI-MATERIAL HANDLE (PP+TPR)

with finger guards for better efficiency and a comfortable grip



INDUCTION HARDENED CUTTING EDGES

for precise work and greater reliability in cutting

SERRATED JAW

providing maximum gripping power

DYNAGRIP[™] LONG NOSE PLIERS

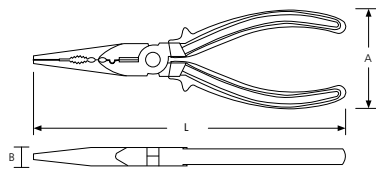

- Forged carbon steel jaws fully heat treated for optimum performance and durability
- Induction hardened cutting edges for greater reliability in cutting
- Bi-material soft grip handle provides excellent comfort
- Ergonomically designed DYNAGRIP[™] handle with finger guards for better efficiency and handling

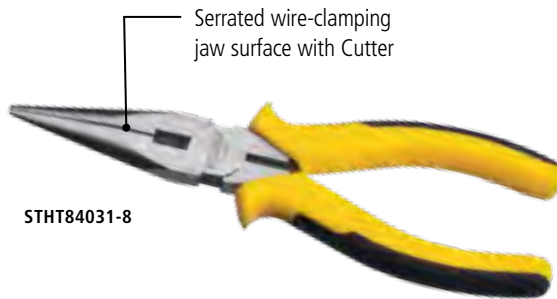

STHT84031-8

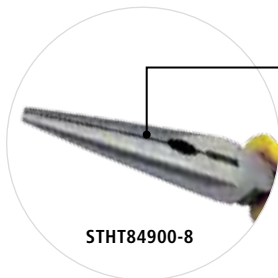

STHT84900-8

Serrated wire-clamping and pipe gripped jaw surface with Cutter



STHT84053-8

Serrated wire-clamping and wire stripping jaw surface with Cutter



SKU #	Description	A (mm)	B (mm)	L (mm)	Box Qty
STHT84031-8	6" Long Nose Pliers	58.3	14.7	174.8	6
STHT84900-8	6" Long Nose Pliers	50	10	160	12
STHT84053-8	6" Long Nose Pliers	50	10	160	12
STHT84032-8	8" Long Nose Pliers	49.6	11.2	201	6

DYNAGRIP™ LINESMAN PLIERS

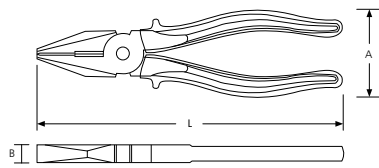

- Forged carbon steel jaws fully heat treated for optimum performance and durability
- Induction hardened cutting edges for greater reliability in cutting
- Bi-material soft grip handle provides excellent comfort
- Ergonomically designed DYNAGRIP™ handle with finger guards for better efficiency and handling



SKU #	Description	A (mm)	B (mm)	L (mm)	Box Qty
STHT84623-8	6" Linesman Pliers	44.8	12	164.6	6
STHT84035-8	7" Linesman Pliers	60	12.4	193	6
STHT84029-8	8" Linesman Pliers	60.5	19.5	219.9	6
STHT84609-8	9" Linesman Pliers	58	14.7	240	6

DYNAGRIP™ DIAGONAL CUTTING PLIERS

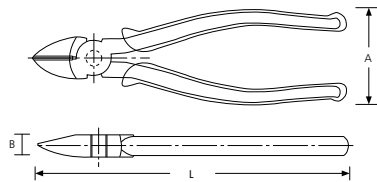

6"



7" & 8"

- Forged carbon steel jaws fully heat treated for optimum performance and durability
- Induction hardened cutting edges for greater reliability in cutting
- Bi-material soft grip handle provides excellent comfort
- Ergonomically designed DYNAGRIP™ handle with finger guards for better efficiency and handling



SKU #	Description	A (mm)	B (mm)	L (mm)	Box Qty
STHT84027-8	6" Diagonal Cutting Pliers	61.3	16.5	163.1	6
STHT84028-8	7" Heavy Duty Diagonal Cutting Pliers	57	11.3	180	6
STHT84607-8	8" Heavy Duty Diagonal Cutting Pliers	60	11.7	205	6

DYNAGRIP™ BENT NOSE PLIERS

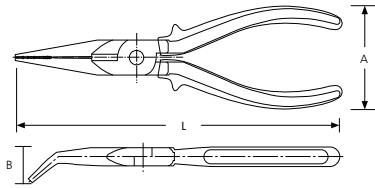

- Forged carbon steel jaws fully heat treated for optimum performance and durability
- Induction hardened cutting edges for greater reliability in cutting
- Bi-material soft grip handle provides excellent comfort
- Ergonomically designed DYNAGRIP™ handle with finger guards for better efficiency and handling

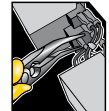

SKU #	Description	A (mm)	B (mm)	L (mm)	Box Qty
STHT84071-8	6" Bent Nose Pliers	48	10	157.7	6
STHT84072-8	8" Bent Nose Pliers	11.5	51	200	6

DYNAGRIP™ END NIPPER PLIERS

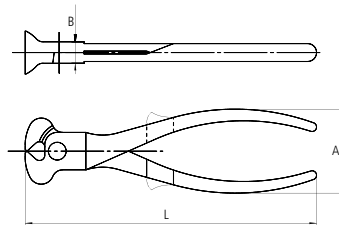

- Forged carbon steel jaws fully heat treated for optimum performance and durability
- Induction hardened cutting edges for greater reliability in cutting
- Bi-material soft grip handle provides excellent comfort
- Ergonomically designed DYNAGRIP™ handle with finger guards for better efficiency and handling



SKU #	Description	A (mm)	B (mm)	L (mm)	Box Qty
STHT84077-8	6" End Nipper Pliers	52	11.9	163	6
STHT84167-8	8" End Nipper Pliers	50	11	202	6

DYNAGRIP™ SLIP JOINT PLIERS

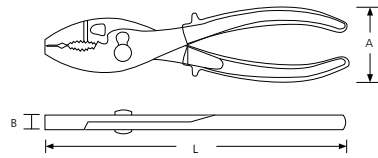

- Forged carbon steel jaws fully heat treated for optimum performance and durability
- Bi-material soft grip handle provides excellent comfort
- Ergonomically designed DYANGRIP™ handle with finger guards for better efficiency and handling



SKU #	Description	A (mm)	B (mm)	L (mm)	Box Qty
STHT84055-8	6" Slip Joint Pliers	46	10.5	156	6
STHT84026-8	8" Slip Joint Pliers	52	11	209	6

DYNAGRIP™ GROOVE JOINT PLIERS

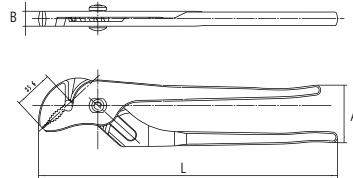

- Forged carbon steel jaws fully heat treated for optimum performance and durability
- Bi-material soft grip handle provides excellent comfort
- Ergonomically designed DYANGRIP™ handle with finger guards for better efficiency and handling



SKU #	Description	A (mm)	B (mm)	L (mm)	Box Qty
STHT84034-8	8" Groove Joint Pliers	45.5	10.3	198	6
STHT84024-8	10" Groove Joint Pliers	65.5	10.3	257.7	6
STHT84021-8	12" Groove Joint Pliers	64	12	308	6

DYNAGRIP™ FLAT NOSE PLIERS

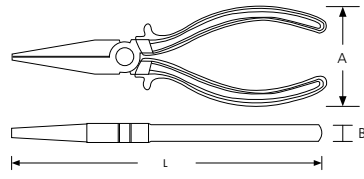

- Forged carbon steel jaws fully heat treated for optimum performance and durability
- Bi-material soft grip handle provides excellent comfort
- Ergonomically designed DYANGRIP™ handle with finger guards for better efficiency and handling



SKU #	Description	A (mm)	B (mm)	L (mm)	Box Qty
STHT84073-8	6" Flat Nose Pliers	56	10.2	165	6

DYNAGRIP™ ROUND NOSE PLIERS

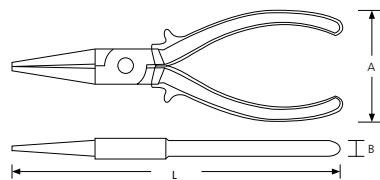

- Forged carbon steel jaws fully heat treated for optimum performance and durability
- Bi-material soft grip handle provides excellent comfort
- Ergonomically designed DYANGRIP™ handle with finger guards for better efficiency and handling



SKU #	Description	A (mm)	B (mm)	L (mm)	Box Qty
STHT84074-8	6" Round Nose Pliers	47.7	8.9	162	6

DYNAGRIP™ WIRE STRIPPER PLIERS

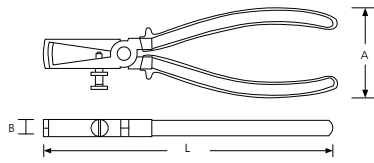

- Forged carbon steel jaws fully heat treated for optimum performance and durability
- Bi-material soft grip handle provides excellent comfort
- Ergonomically designed DYANGRIP™ handle with finger guards for better efficiency and handling



SKU #	Description	A (mm)	B (mm)	L (mm)	Box Qty
STHT84075-8	6" Wire Stripper Pliers	57	9	161.3	6

DYNAGRIP™ COMBINATION PLIERS

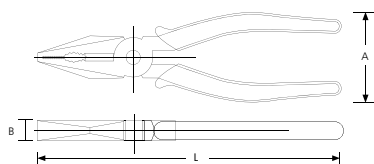

- Forged carbon steel jaws fully heat treated for optimum performance and durability
- Induction hardened cutting edges for greater reliability in cutting
- Bi-material soft grip handle provides excellent comfort
- Ergonomically designed DYANGRIP™ handle with finger guards for better efficiency and handling



SKU #	Description	A (mm)	B (mm)	L (mm)	Box Qty
STHT70487-8	7" Combination Pliers	50.4	12.8	188.5	12

BASIC LONG NOSE PLIERS

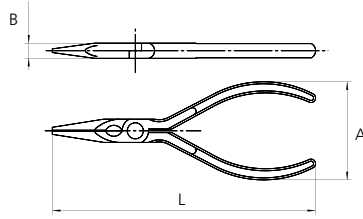

- Forged carbon steel jaws fully heat treated for optimum performance and durability
- Double dipped handle allows for a comfortable grip
- Drop-forged steel is strong and durable
- Meets ANSI specifications



SKU #	Description	A (mm)	B (mm)	L (mm)	Box Qty
STHT84119-8	4" Long Nose Pliers-Miniature	48.5	7.5	130	6
STHT84100-8	5" Long Nose Pliers	50.2	7.5	141	6
STHT84101-8	6" Long Nose Pliers	48.6	9.5	170	6
STHT84102-8	8" Long Nose Pliers	50	11.2	200	6

BASIC LINESMAN PLIERS

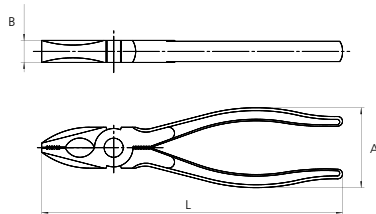

- Forged carbon steel jaws fully heat treated for optimum performance and durability
- Double dipped handle allows for a comfortable grip
- Drop-forged steel is strong and durable
- Meets ANSI specifications



SKU #	Description	A (mm)	B (mm)	L (mm)	Box Qty
STHT84112-8	7" Linesman Pliers	50	12.5	188	6
STHT84113-8	8" Linesman Pliers	50	12.8	218	6
STHT84222-8	9" Heavy Duty Linesman Pliers	50	14.2	234	6

BASIC DIAGONAL CUTTING PLIERS

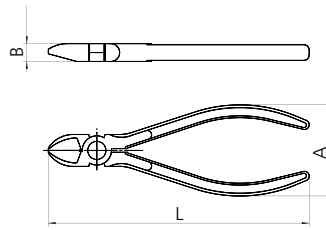

- Forged carbon steel jaws fully heat treated for optimum performance and durability
- Double dipped handle allows for a comfortable grip
- Drop-forged steel is strong and durable
- Meets ANSI specifications



SKU #	Description	A (mm)	B (mm)	L (mm)	Box Qty
STHT84124-8	4" Diagonal Cutting Pliers-Miniature	48.5	7.5	109.5	6
STHT84104-8	5" Diagonal Cutting Pliers	50	8.8	143	6
STHT84105-8	6" Diagonal Cutting Pliers	50	10.5	154.5	6
STHT84108-8	7" Diagonal Cutting Pliers	50	11.5	180	6

BASIC HIGH LEVERAGE CABLE CUTTING PLIERS

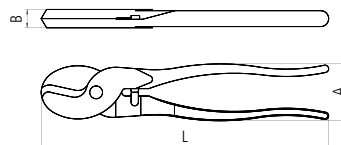

- Forged carbon steel jaws fully heat treated for optimum performance and durability
- Double dipped handle allows for a comfortable grip
- Drop-forged steel is strong and durable
- Meets ANSI specifications



SKU #	Description	A (mm)	B (mm)	L (mm)	Box Qty
STHT84258-8	9-1/2" High Leverage Cable Cutting Pliers	46.5	14	235	6

BASIC BENT NOSE PLIERS

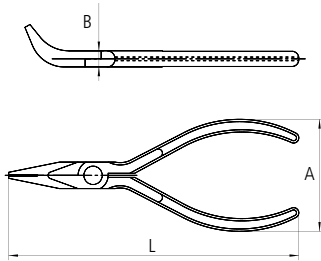

- Forged carbon steel jaws fully heat treated for optimum performance and durability
- Double dipped handle allows for a comfortable grip
- Drop-forged steel is strong and durable
- Meets ANSI specifications



SKU #	Description	A (mm)	B (mm)	L (mm)	Box Qty
STHT84126-8	5" Bent Nose Pliers-Miniature	48.5	7.5	125.5	6

BASIC END NIPPER PLIERS

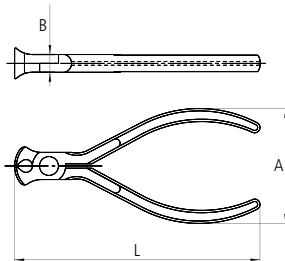

- Forged carbon steel jaws fully heat treated for optimum performance and durability
- Double dipped handle allows for a comfortable grip
- Drop-forged steel is strong and durable
- Meets ANSI specifications



SKU #	Description	A (mm)	B (mm)	L (mm)	Box Qty
STHT84125-8	4" End Nipper Pliers-Miniature	48.5	7.5	103.5	6

BASIC SLIP JOINT PLIERS

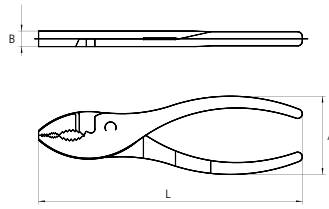

- Forged carbon steel jaws fully heat treated for optimum performance and durability
- Double dipped handle allows for a comfortable grip
- Drop-forged steel is strong and durable
- Meets ANSI specifications



SKU #	Description	A (mm)	B (mm)	L (mm)	Box Qty
STHT84097-8	6" Slip Joint Pliers	50	9	168	6
STHT84098-8	8" Slip Joint Pliers	49	9.6	208.5	6

BASIC GROOVE JOINT PLIERS

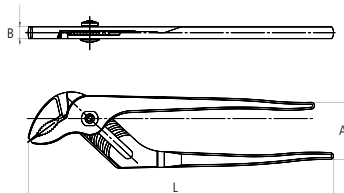

- Forged carbon steel jaws fully heat treated for optimum performance and durability
- Double dipped handle allows for a comfortable grip
- Drop-forged steel is strong and durable
- Meets ANSI specifications



SKU #	Description	A (mm)	B (mm)	L (mm)	Box Qty
STHT84110-8	10" Groove Joint Pliers	48.2	10	258	6

BASIC FLAT NOSE PLIERS

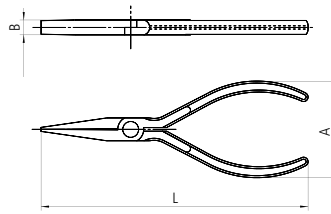

- Forged carbon steel jaws fully heat treated for optimum performance and durability
- Double dipped handle allows for a comfortable grip
- Drop-forged steel is strong and durable
- Meets ANSI specifications



SKU #	Description	A (mm)	B (mm)	L (mm)	Box Qty
STHT84122-8	4" Flat Nose Pliers-Miniature	48.5	7.5	134	6

BASIC NEEDLE NOSE PLIERS

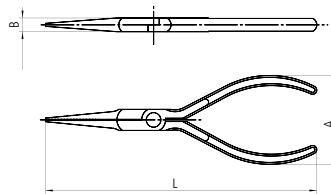

- Forged carbon steel jaws fully heat treated for optimum performance and durability
- Double dipped handle allows for a comfortable grip
- Drop-forged steel is strong and durable
- Meets ANSI specifications



SKU #	Description	A (mm)	B (mm)	L (mm)	Box Qty
STHT84096-8	5" Needle Nose Pliers-Miniature	48.5	7.5	148	6

BASIC FENCE PLIERS

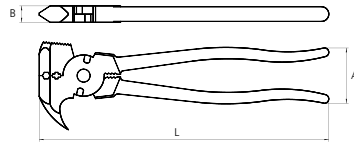

- Forged carbon steel jaws fully heat treated for optimum performance and durability
- Double dipped handle allows for a comfortable grip
- Drop-forged steel is strong and durable
- Meets ANSI specifications



SKU #	Description	A (mm)	B (mm)	L (mm)	Box Qty
STHT84221-8	10" Fence Pliers	51	13.5	267	6

BASIC CIRCLIP PLIERS

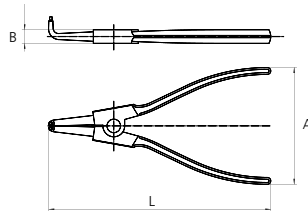

Straight



Bent

- Forged carbon steel jaws fully heat treated for optimum performance and durability
- Double dipped handle allows for a comfortable grip
- Drop-forged steel is strong and durable
- Meets ANSI specifications



SKU #	Description	A (mm)	B (mm)	L (mm)	Box Qty
STHT84271-8	7" Circlip Plier Straight Exterior Type	86	10	174	6
STHT84272-8	7" Circlip Plier Bent Exterior Type	86	10	163	12
STHT84273-8	7" Circlip Plier Straight Interior Type	49	9	179	6
STHT84274-8	7" Circlip Plier Bent Interior Type	49	9	169	12

DYNAGRIP™ CURVED JAW PRO LOCKING PLIERS

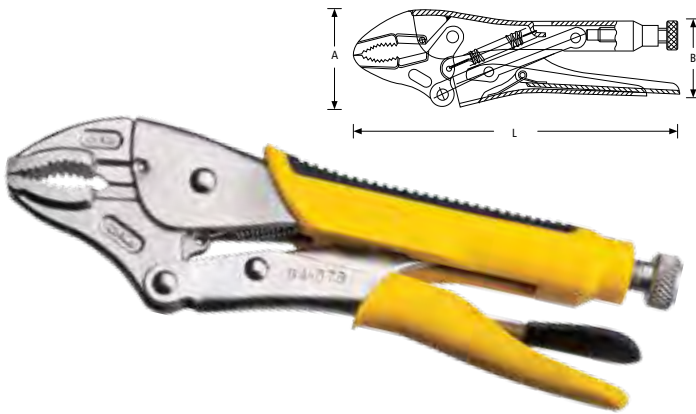

- Chrome plating is corrosion resistant
- Forged and machined jaws for maximum durability
- Screws adjust the jaws and the clamping pressure amount for precision
- Safety and ease when opening



SKU #	Description	A (mm)	B (mm)	L (mm)	Box Qty
STHT84378-8	10" Curved Jaw Pro Locking Pliers	65	60	254	6

DYNAGRIP™ STRAIGHT JAW PRO LOCKING PLIERS

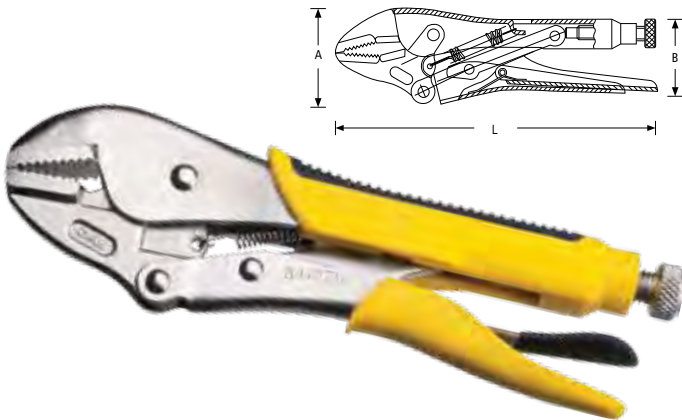

- Chrome plating is corrosion resistant
- Forged and machined jaws for maximum durability
- Screws adjust the jaws and the clamping pressure amount for precision
- Safety and ease when opening



SKU #	Description	A (mm)	B (mm)	L (mm)	Box Qty
STHT84379-8	10" Straight Jaw Pro Locking Pliers	66	47	254	6

DYNAGRIP™ LONG NOSE PRO LOCKING PLIERS

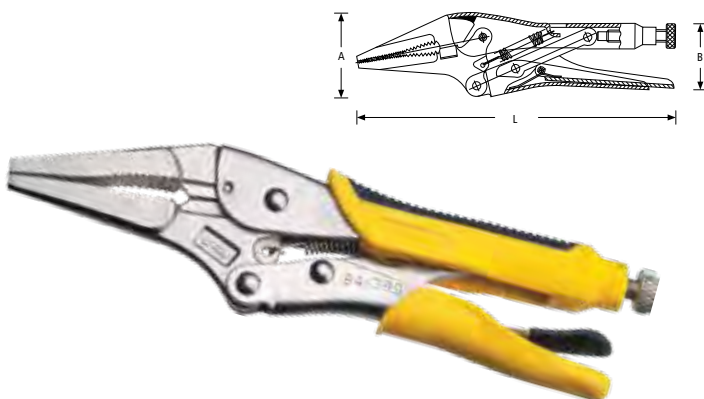

- Chrome plating is corrosion resistant
- Forged and machined jaws for maximum durability
- Screws adjust the jaws and the clamping pressure amount for precision
- Safety and ease when opening



SKU #	Description	A (mm)	B (mm)	L (mm)	Box Qty
STHT84389-8	9-1/2" Long Nose Pro Locking Pliers	50.8	47.8	228	6

CURVED JAW LOCKING PLIERS

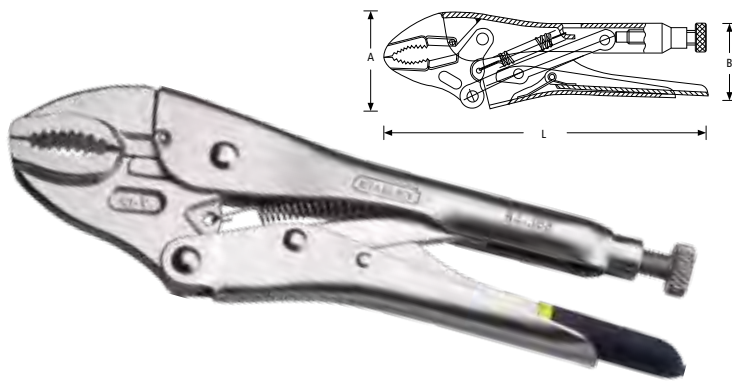

- Chrome plating is corrosion resistant
- Forged and machined jaws for maximum durability
- Screws adjust the jaws and the clamping pressure amount for precision
- Safety and ease when opening



SKU #	Description	A (mm)	B (mm)	L (mm)	Box Qty
STHT84368-8	7" Curved Jaw Locking Pliers	56	56	175	6
STHT84369-8	10" Curved Jaw Locking Pliers	66	66	254	6

STRAIGHT JAW LOCKING PLIERS

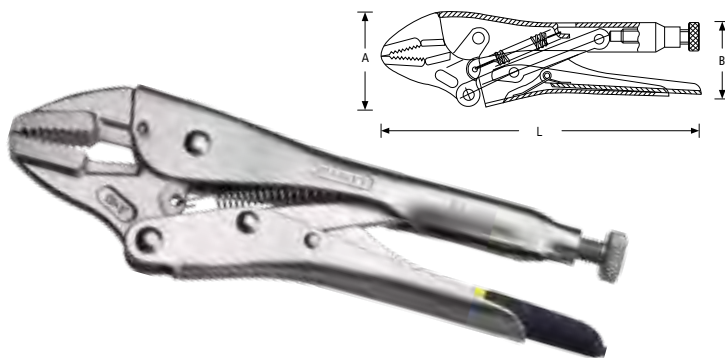

- Chrome plating is corrosion resistant
- Forged and machined jaws for maximum durability
- Screws adjust the jaws and the clamping pressure amount for precision
- Safety and ease when opening



SKU #	Description	A (mm)	B (mm)	L (mm)	Box Qty
STHT84370-8	7" Straight Jaw Locking Pliers	55	55	175	4
STHT84371-8	10" Straight Jaw Locking Pliers	66	66	254	4

LONG NOSE LOCKING PLIERS

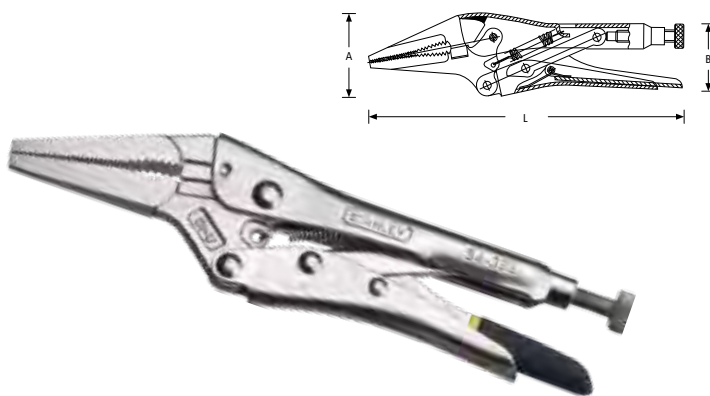

- Chrome plating is corrosion resistant
- Forged and machined jaws for maximum durability
- Screws adjust the jaws and the clamping pressure amount for precision
- Safety and ease when opening



SKU #	Description	A (mm)	B (mm)	L (mm)	Box Qty
STHT84396-8	6-1/2" Long Nose Locking Pliers	45	37	165	6

WELDING LOCKING PLIERS

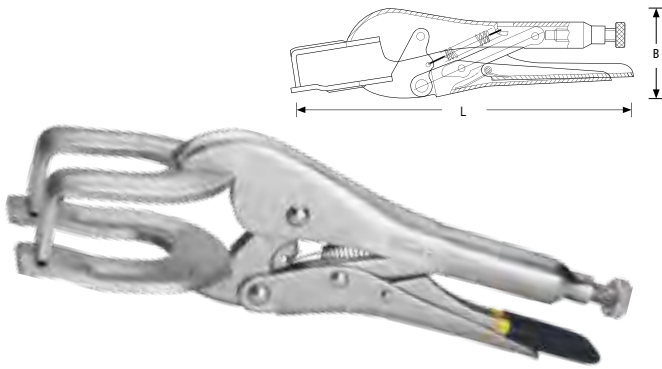

- Chrome plating is corrosion resistant
- Forged and machined jaws for maximum durability
- Screws adjust the jaws and the clamping pressure amount for precision
- Safety and ease when opening



SKU #	Description	B (mm)	L (mm)	Box Qty
STHT84397-8	9" Welding Locking Pliers	37.8	228	4

SHEET METAL LOCKING PLIERS

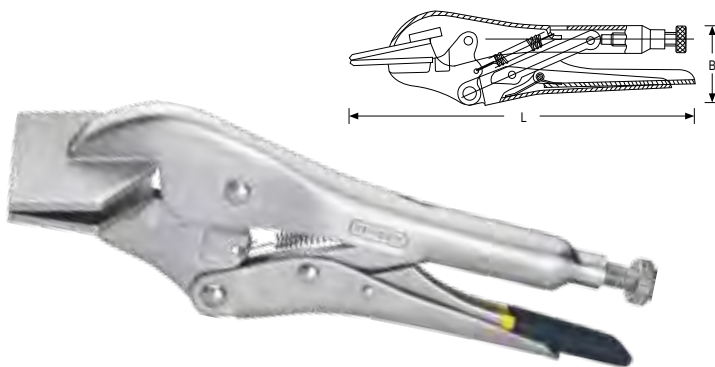

- Chrome plating is corrosion resistant
- Forged and machined jaws for maximum durability
- Screws adjust the jaws and the clamping pressure amount for precision
- Safety and ease when opening



SKU #	Description	B (mm)	L (mm)	Box Qty
STHT84398-8	8" Sheet Metal Locking Pliers	36.7	228	4

C CLAMPS LOCKING PLIERS

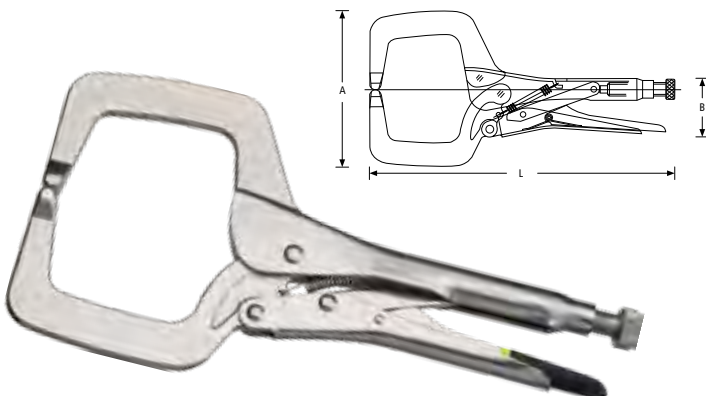

- Chrome plating is corrosion resistant
- Forged and machined jaws for maximum durability
- Screws adjust the jaws and the clamping pressure amount for precision
- Safety and ease when opening



SKU #	Description	A (mm)	B (mm)	L (mm)	Box Qty
STHT84399-8	11" C Clamps Locking Pliers	138	47.2	279	6

3 PCS BASIC PLIERS SET



- 8" Linesman Pliers
- 6" Diagonal Cutting Pliers
- 6" Long Nose Pliers

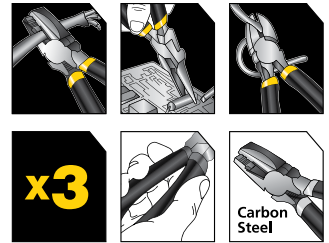

SKU #	Description	Box Qty
STHT90162-8	3 PCS Basic Pliers Set	4

2 PCS BASIC PLIERS SET



- 8" Linesman Pliers
- 6" Diagonal Cutting Pliers

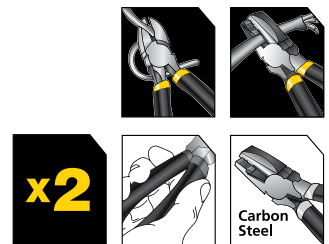

SKU #	Description	Box Qty
STHT90163-8	2 PCS Basic Pliers Set	4

2 PCS LINESMAN PLIERS & ADJUSTABLE WRENCH SET



- 8" Linesman Pliers
- 6" Adjustable Wrench

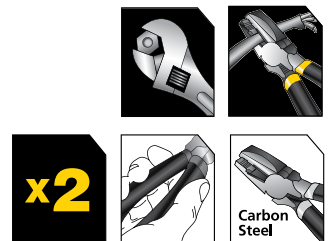

SKU #	Description	Box Qty
STHT90164-8	2 PCS Linesman Pliers & Adjustable Wrench Set	4

4 PCS PLIERS & ADJUSTABLE WRENCH SET



- 6" Linesman Pliers
- 6" Long Nose Pliers
- 8" Cutting Pliers
- 8" Adjustable Wrench

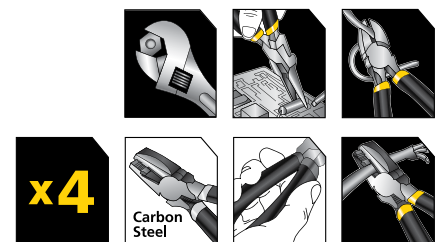

SKU #	Description	Box Qty
STHT91526-8	4 PCS Pliers & Adjustable Wrench Set	4

4 PCS PLIERS MODULE



- 8" Bent nose pliers
- 6" Diagonal cutting pliers
- 7" Linesman pliers
- 8" Slip joint pliers

COMPATIBLE with
**TRANS
MODULE**
system



SKU #	Description	Length (mm)	Width (mm)	Height (mm)	Carton Qty
STMT74179-8	4 PCS Pliers Module	384	184	45	4

4 PCS CIRCLIPS PLIERS MODULE



- 7" Basic circlip plier straight exterior type
- 7" Basic circlip plier bent exterior type
- 7" Basic circlip plier straight interior type
- 7" Basic circlip plier bent interior type

COMPATIBLE with
**TRANS
MODULE**
system



SKU #	Description	Length (mm)	Width (mm)	Height (mm)	Carton Qty
STMT74180-8	4 PCS Circlips Pliers Module	384	184	45	4

DYNAGRIP™ 3 PCS SET



- 7" Combination Pliers
- 6" Diagonal Cutting Pliers
- 6" Long Nose Pliers



SKU #	Description	Weight (kg)
STHT73655-8	Dynagrip 3 pcs set	0.64

VDE DIAGONAL CUTTING PLIERS



- Safe live line working to 1,000V
- DIN / ASO / ANSI compliant

SKU #	Description	Length (mm)	Box Qty
84-004	8" Diagonal Cutting Pliers	195	4
84-006	6" Long Nose Pliers	165	4
84-007	8.5" Long Nose Pliers	200	4
84-010	6.5" Wire Stripper Pliers	170	4
84-016	6.5" End Cutters	165	4

FATMAX® VDE PLIERS



- Safe live line working to 1,000v
- Individually tested to 10,000v
- Compliant to EN60900, IEC/CEI900, VDE688
- Bi-material handle with secure grip grooving for comfort
- Heat treated high chrome steel forging for long life and durability
- Hand ground, induction hardened blade for long life and accuracy
- Finger guard for better control & added user safety
- Interlocking joint assembly for smooth cutting
- DIN/ ASO/ ANSI Compliant

SKU #	Length Description	Box/CTN
84-000	160mm/6" Combination (2101NV)	4/24
84-001	180mm/7" Combination (2201NV)	4/24
84-002	200mm/8" Combination (2301NV)	4/24
84-009	160mm/6-1/4" Narrow Head Diagonal Pliers	4/24
84-011	3pcs Pliers Sets (84-001, 84-003 & 84-007)	4/4

COMBINATION SNAP RING PLIERS



- Internal- External positioning 45°- 90°-180°
- 10-50mm range

SKU #	Length		Box/CTN
	mm	inches	
84-168	152	6"	20/60

CRIMPING PLIERS



- Cuts electrical wires, strips insulation, shears screws and bolts clean (Warning: Grips do not protect against electrical shock.)

SKU #	O / A Length		Box/CTN
	mm	inches	
84-223 (Plier)	230	9"	10/100
84-253 (Set)	230	9"	6/36

PIPE PLIERS

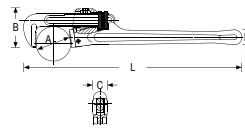

- Jaw forged in Cr-Mo steel
- Cast iron body

SKU #	Description	L (mm)	A (mm)	B (mm)	C (mm)	D (mm)	Box Qty
87-620-S	6" Pipe Pliers	150	21.5	41	20	16	6
87-621-S	8" Pipe Pliers	200	26.75	50	23.5	16.6	6
87-622-S	10" Pipe Pliers	250	33.5	63	27.5	22.4	6
87-623-S	12" Pipe Pliers	300	42.5	76	30	24	6
87-624-S	14" Pipe Pliers	350	48	81	33.5	24	6
87-625-S	18" Pipe Pliers	450	60	100	37	31	2
87-626-S	24" Pipe Pliers	600	75.5	120	45	40	2
87-627-S	36" Pipe Pliers	900	102	158	52	49	2
87-629-S	48" Pipe Pliers	1200	140	179	57.5	61	2

CAST STEEL BENCH VISE



- Better Performance
- Better than Iron
- Lightweight compared to Iron

SKU #	Description	Size	Jaw Width/Max Opening	Throat Depth	N.W.(Kg)	Clamp Force (Kg)	Box/CTN
81-600-1	Bench Vice w/ Base	3"	3"/3"	2"	6kgs	1,500kgs	1/1
81-601-1	Bench Vice w/ Base	4"	4"/4"	2-1/4"	7.5kgs	2,500kgs	1/1
81-602-1	Bench Vice w/ Base	5"	5"/5"	2-5/8"	11kgs	3,000kgs	1/1
81-603-1	Bench Vice w/ Base	6"	6"/6"	3"	14.5kgs	3,500kgs	1/1
81-604-1	Bench Vice w/ Base	8"	8"/8"	3-1/2"	20.5kgs	4,500kgs	1/1
81-605-1	Bench Vice w/ Base	10"	10"/10"	4"	25.6kgs	5,500kgs	1/1

BIT BRACE



- Holds shank bit from 1/8" to 7/16"
- Steel clad ball bearing head
- Chrome plated finish for rust resistance
- Available in 10" and 12" sweep

SKU #	O / A Length		Chuck Size		Box/CTN
	mm	inches	mm	inches	
02-110	255	10"	13	1/2"	6/24
02-112	305	12"	13	1/2"	6/24
02-130	255	10"	16	5/8"	6/24

STANLEY®

FASTENING TOOLS



Screwdrivers

Multi-Tools

Bits

Hex & Torx Keys

Staples

Glue & Soldering Guns

Riveters





DO YOU KNOW...

Which happened first?

- A. The invention of the light bulb.
- B. The manufacturing of STANLEY® screwdrivers.

Ans: B. STANLEY® manufactured screwdriver in 1870; Electric light bulb was invented in 1879.

MAKING EACH TURN COUNT

STANLEY® is one of the preeminent manufacturers of fastening tools and is responsible for helping to elevate the performance of these must-have tools. The excellent quality coupled with durability has propelled the extensive range of fastening tools to be the most highly coveted in the world.

SCREWDRIVERS

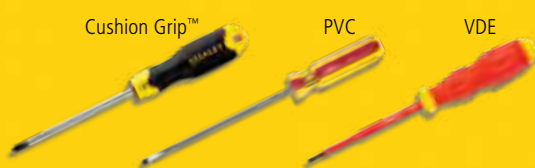

STANLEY® has a full range of screwdrivers. They are sold individually or packaged in convenient multi-piece kits.

We also offer a line of multi-bits and interchangeable bars/bits screwdrivers.

MULTI-TOOLS



This versatile tool features a stunningly compact design. With up to 14 tools compressed into one clever model, the multi-tool is built from solid steel for maximum strength. It also features a 400 in-lbs maximum torque.

BITS



STANLEY® bits are available as a combination with screwdrivers or as a stand-alone product. Together, they have a magnetism that allows for fast and secure bit changing. Made from chrome vanadium steel, the bits are undoubtedly built to last and come in a conveniently packaged storage option.

HEX KEYS



Made from durable composite materials, all the hex keys feature a compact design and exceed ANSI specifications.



CUSHION GRIP™ SCREWDRIVER RANGE OVERVIEW



PHILLIPS®

Tip Size	Bar Length (mm)	Total Length (mm)	Handle Diameter (mm)
PH0	60	76.5	16.5
	100	116.5	
	125	141.5	
	150	166.5	
PH1	75	104.5	29.5
	100	129.5	
	150	179.5	
	200	229.5	
PH2	45	74.2	32.2
	100	132.2	
	125	157.2	
	150	182.2	
	200	232.2	
PH3	150	184.3	34.3
	200	234.3	
	250	284.3	



SLOTTED FLARED

Tip Size	Bar Length (mm)	Total Length (mm)	Handle Diameter (mm)
3mm	75	91.5	16.5
	100	116.5	
	125	141.5	
	150	166.5	
5mm	75	104.5	29.5
	100	129.5	
	150	179.5	
	200	229.5	
6.5mm	45	74.2	32.2
	100	132.2	
	125	157.2	
	150	182.2	
	200	203.2	
8mm	150	184.3	34.3
	200	234.3	
	250	284.3	



TORX

Tip Size	Bar Length (mm)	Total Length (mm)	Handle Diameter (mm)
T5	80	96.5	16.5
T6			
T7			
T8			
T10			
T15	80	109.5	29.5
T20	120	149.5	29.5
T25	120	152.2	32.2
T27			
T30			
T40			



SLOTTED PARALLEL

Tip Size	Bar Length (mm)	Total Length (mm)	Handle Diameter (mm)
5mm	100	129.5	29.5
	150	179.5	
	200	229.5	

SCREWDRIVER SETS

6 PCS Cushion Grip™ Screwdriver Set with Bonus (Tester included)

8 PCS Cushion Grip™ Screwdriver Set

6 PCS Cushion Grip™ Screwdriver Set

4 PCS Cushion Grip™ Screwdriver Set

2 PCS Cushion Grip™ Screwdriver Set

5 PCS Cushion Grip™ TORX Screwdriver Set

6 PCS Cushion Grip™ TORX Screwdriver Set

STANLEY®

CUSHION GRIP™ SCREWDRIVERS RANGE

The **STANLEY® CUSHION GRIP™** range is fully patented and meets ANSI standards, proving the range's durability and precision. These tools have easy-to-hold handles that are comfortable and ergonomic.

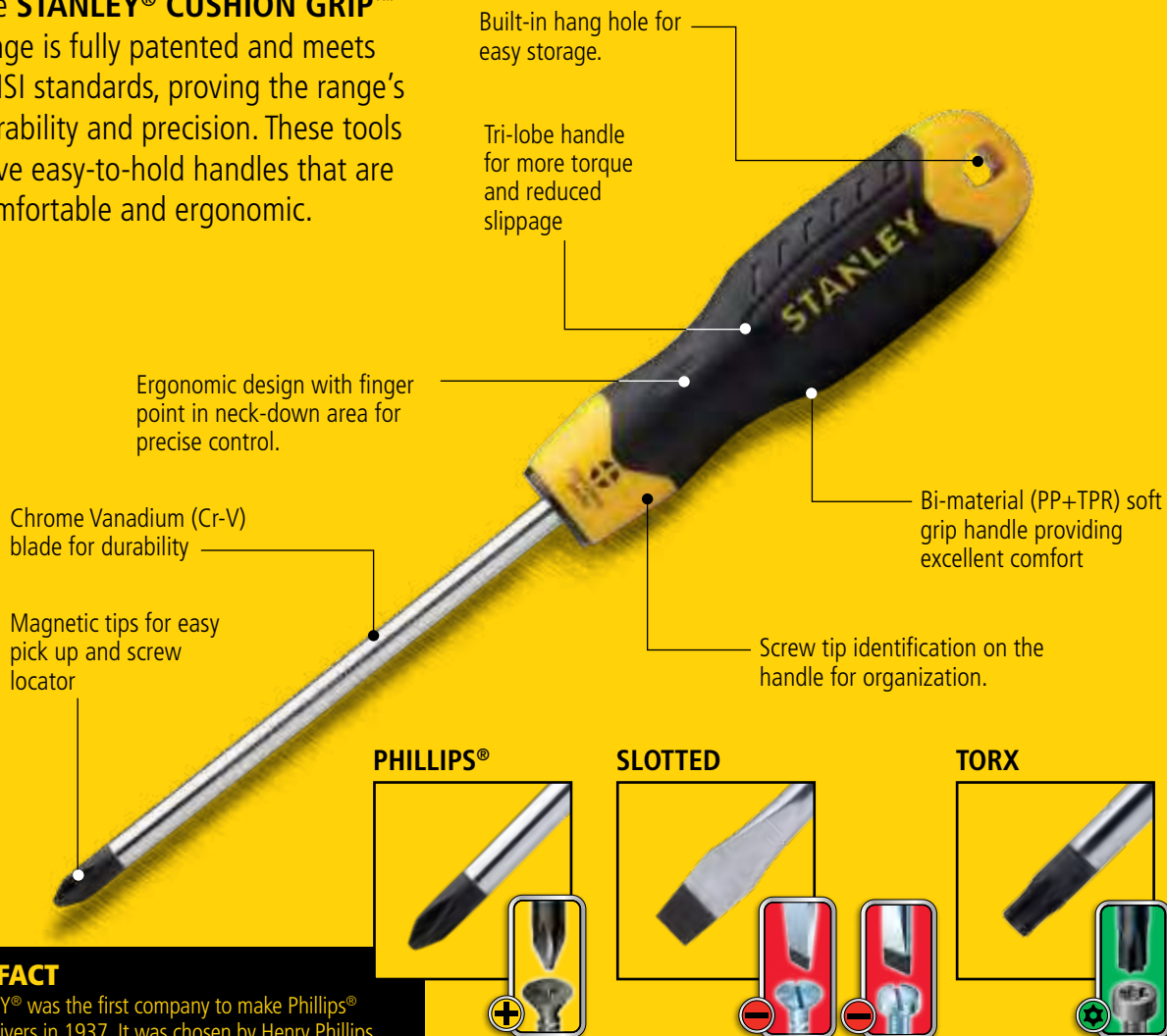

PHILLIPS®



SLOTTED

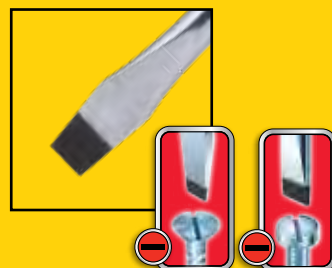

TORX

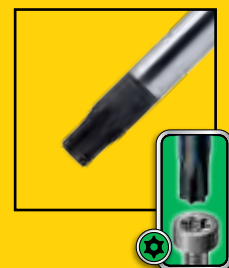

FUN FACT

STANLEY® was the first company to make Phillips® screwdrivers in 1937. It was chosen by Henry Phillips, the inventor of the Phillips® head screw.



UNIT PACK

Bold and attractive single packs exploit key features and provide clear user information. Minimal packaging allows full tactile opportunities with security.

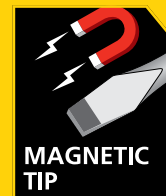

BULK PACK

For wholesalers, bulk packs represent great value. Sturdy boxes with bold branding and full EPOS labelling help to keep stock under control. Shipper and promotional packs are also available for some product lines.

CUSHION GRIP™ PHILLIPS®

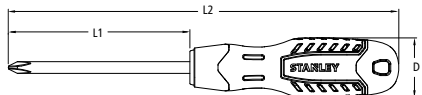
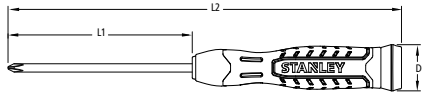
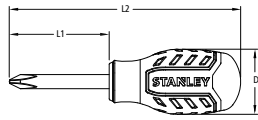

- Bi-material (PP+TPR) soft grip handle providing excellent comfort
- Chrome Vanadium (Cr-V) blade for durability
- Magnetic tips for easy pick up and screw locator
- Three-sided handle allowing more torque with anti-slip and anti rolling features reducing handle slippage
- Ergonomic design with finger point in neck-down area for precise control
- Built-in hang hole for easy storage
- Screw tip identification on the handle for organization

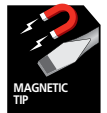

Retail SKU #	Bulk SKU #	Description	Tip Size	L1 (mm)	L2 (mm)	D (mm)	Box Qty
STHT65157-8	STHT65157-8B	Cushion Grip™ PH0 X 60mm	PH0	60	76.5	16.5	12
STHT65158-8	STHT65158-8B	Cushion Grip™ PH0 X 100mm	PH0	100	116.5	16.5	12
STHT65159-8	STHT65159-8B	Cushion Grip™ PH0 X 125mm	PH0	125	141.5	16.5	12
STHT65160-8	STHT65160-8B	Cushion Grip™ PH0 X 150mm	PH0	150	166.5	16.5	12
STHT65162-8	STHT65162-8B	Cushion Grip™ PH1 X 75mm	PH1	75	104.5	29.5	12
STHT65163-8	STHT65163-8B	Cushion Grip™ PH1 X 100mm	PH1	100	129.5	29.5	12
STHT65164-8	STHT65164-8B	Cushion Grip™ PH1 X 150mm	PH1	150	179.5	29.5	12
STHT65165-8	STHT65165-8B	Cushion Grip™ PH1 X 200mm	PH1	200	229.5	29.5	12
STHT65166-8	STHT65166-8B	Cushion Grip™ PH2 X 45mm	PH2	45	74.2	29.2	12
STHT65167-8	STHT65167-8B	Cushion Grip™ PH2 X 100mm	PH2	100	132.2	32.2	12
STHT65168-8	STHT65168-8B	Cushion Grip™ PH2 X 125mm	PH2	125	157.2	32.2	12
STHT65169-8	STHT65169-8B	Cushion Grip™ PH2 X 150mm	PH2	150	182.2	32.2	12
STHT65170-8	STHT65170-8B	Cushion Grip™ PH2 X 200mm	PH2	200	232.2	32.2	12
STHT65171-8	STHT65171-8B	Cushion Grip™ PH2 X 250mm	PH2	250	282.2	32.2	12
STHT65172-8	STHT65172-8B	Cushion Grip™ PH3 X 150mm	PH3	150	184.3	34.3	12
STHT65173-8	STHT65173-8B	Cushion Grip™ PH3 X 200mm	PH3	200	234.3	34.3	12
STHT65174-8	STHT65174-8B	Cushion Grip™ PH3 X 250mm	PH3	250	284.3	34.3	12

CUSHION GRIP™ SLOTTED FLARED

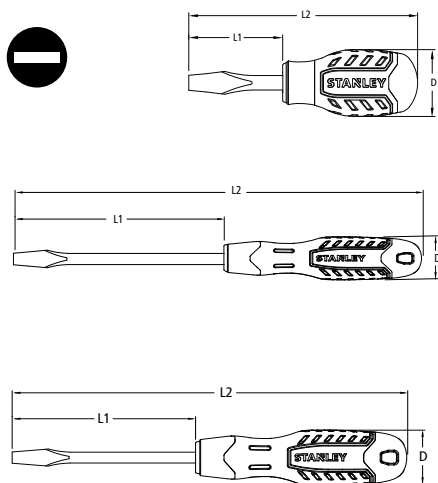

- Bi-material (PP+TPR) soft grip handle providing excellent comfort
- Chrome Vanadium (Cr-V) blade for durability
- Magnetic tips for easy pick up and screw locator
- Three-sided handle allowing more torque with anti-slip and anti rolling features reducing handle slippage
- Ergonomic design with finger point in neck-down area for precise control
- Built-in hang hole for easy storage
- Screw tip identification on the handle for organization

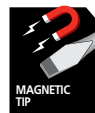

Retail SKU #	Bulk SKU #	Description	Tip Size	L1 (mm)	L2 (mm)	D (mm)	Box Qty
STHT65180-8	STHT65180-8B	Cushion Grip™ Standard 3mm X 75mm	3mm	75	91.5	16.5	12
STHT65181-8	STHT65181-8B	Cushion Grip™ Standard 3mm X 100mm	3mm	100	116.5	16.5	12
STHT65182-8	STHT65182-8B	Cushion Grip™ Standard 3mm X 125mm	3mm	125	141.5	16.5	12
STHT65183-8	STHT65183-8B	Cushion Grip™ Standard 3mm X 150mm	3mm	150	166.5	16.5	12
STHT65186-8	STHT65186-8B	Cushion Grip™ Standard 5mm X 75mm	5mm	75	104.5	29.5	12
STHT65187-8	STHT65187-8B	Cushion Grip™ Standard 5mm X 100mm	5mm	100	129.5	29.5	12
STHT65188-8	STHT65188-8B	Cushion Grip™ Standard 5mm X 150mm	5mm	150	179.5	29.5	12
STHT65189-8	STHT65189-8B	Cushion Grip™ Standard 5mm X 200mm	5mm	200	229.5	29.5	12
STHT65190-8	STHT65190-8B	Cushion Grip™ Standard 6.5mm X 45mm	6.5mm	45	74.2	29.2	12
STHT65191-8	STHT65191-8B	Cushion Grip™ Standard 6.5mm X 100mm	6.5mm	100	132.2	32.2	12
STHT65192-8	STHT65192-8B	Cushion Grip™ Standard 6.5mm X 125mm	6.5mm	125	157.2	32.2	12
STHT65193-8	STHT65193-8B	Cushion Grip™ Standard 6.5mm X 150mm	6.5mm	150	182.2	32.2	12
STHT65194-8	STHT65194-8B	Cushion Grip™ Standard 6.5mm X 200mm	6.5mm	200	203.2	32.2	12
STHT65195-8	STHT65195-8B	Cushion Grip™ Standard 6.5mm X 250mm	6.5mm	250	282.2	32.2	12
STHT65196-8	STHT65196-8B	Cushion Grip™ Standard 8mm X 150mm	8mm	150	184.3	34.3	12
STHT65197-8	STHT65197-8B	Cushion Grip™ Standard 8mm X 200mm	8mm	200	234.3	34.3	12
STHT65198-8	STHT65198-8B	Cushion Grip™ Standard 8mm X 250mm	8mm	250	284.3	34.3	12

CUSHION GRIP™ SLOTTED PARALLEL

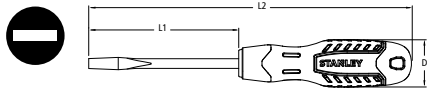

- Bi-material (PP+TPR) soft grip handle providing excellent comfort
- Chrome Vanadium (Cr-V) blade for durability
- Magnetic tips for easy pick up and screw locator
- Three-sided handle allowing more torque with anti-slip and anti rolling features reducing handle slippage
- Ergonomic design with finger point in neck-down area for precise control
- Built-in hang hole for easy storage
- Screw tip identification on the handle for organization

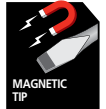

Retail SKU #	Bulk SKU #	Description	Tip Size	L1 (mm)	L2 (mm)	D (mm)	Box Qty
STHT65227-8	STHT65227-8B	Cushion Grip™ Standard Parallel 5mm X 100mm	5mm	100	129.5	29.5	12
STHT65228-8	STHT65228-8B	Cushion Grip™ Standard Parallel 5mm X 150mm	5mm	150	179.5	29.5	12
STHT65229-8	STHT65229-8B	Cushion Grip™ Standard Parallel 5mm X 200mm	5mm	200	229.5	29.5	12

CUSHION GRIP™ TORX

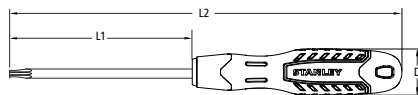
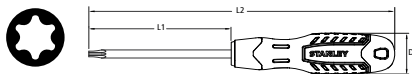

- Bi-material (PP+TPR) soft grip handle providing excellent comfort
- Chrome Vanadium (Cr-V) blade for durability
- Magnetic tips for easy pick up and screw locator
- Three-sided handle allowing more torque with anti-slip and anti rolling features reducing handle slippage
- Ergonomic design with finger point in neck-down area for precise control
- Built-in hang hole for easy storage
- Screw tip identification on the handle for organization

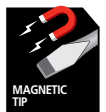

Retail SKU #	Bulk SKU #	Description	Tip Size	L1 (mm)	L2 (mm)	D (mm)	Box Qty
STHT65144-8	STHT65144-8B	Cushion Grip™ TORX T5 X 80mm	T5	80	96.5	16.5	12
STHT65145-8	STHT65145-8B	Cushion Grip™ TORX T6 X 80mm	T6	80	96.5	16.5	12
STHT65146-8	STHT65146-8B	Cushion Grip™ TORX T7 X 80mm	T7	80	96.5	16.5	12
STHT65147-8	STHT65147-8B	Cushion Grip™ TORX T8 X 80mm	T8	80	96.5	16.5	12
STHT65148-8	STHT65148-8B	Cushion Grip™ TORX T10 X 80mm	T10	80	96.5	16.5	12
STHT65149-8	STHT65149-8B	Cushion Grip™ TORX T15 X 80mm	T15	80	109.5	29.5	12
STHT65150-8	STHT65150-8B	Cushion Grip™ TORX T20 X 120mm	T20	120	149.5	29.5	12
STHT65151-8	STHT65151-8B	Cushion Grip™ TORX T25 X 120mm	T25	120	152.2	32.2	12
STHT65152-8	STHT65152-8B	Cushion Grip™ TORX T27 X 120mm	T27	120	152.2	32.2	12
STHT65153-8	STHT65153-8B	Cushion Grip™ TORX T30 X 120mm	T30	120	152.2	32.2	12
STHT65154-8	STHT65154-8B	Cushion Grip™ TORX T40 X 120mm	T40	120	154.3	34.3	12

6 PCS CUSHION GRIP™ SCREWDRIVER SET WITH BONUS (TESTER INCLUDED)



- Phillips® PH1 x 100mm
- Phillips® PH2 x 45mm
- Phillips® PH2 x 100mm
- Slotted 5mm x 100mm
- Slotted 6.5mm x 45mm
- Slotted 6.5mm x 100mm

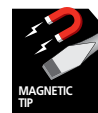

SKU #	Description	Box Qty
STHT92002-8	6 PCS Cushion Grip™ Screwdriver Set with Bonus (Tester included)	12

8 PCS CUSHION GRIP™ SCREWDRIVER SET

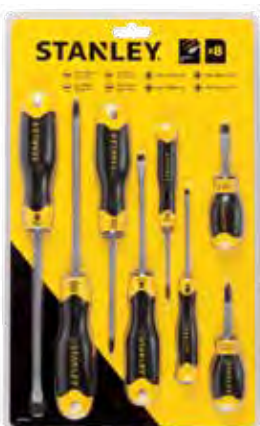

- Phillips® PH0 x 60mm
- Phillips® PH1 x 100mm
- Phillips® PH2 x 45mm
- Phillips® PH2 x 150mm
- Slotted 3mm x 75mm
- Slotted 5mm x 100mm
- Slotted 6.5mm x 45mm
- Slotted 6.5mm x 150mm

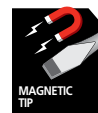

SKU #	Description	Box Qty
STHT92004-8	8 PCS Cushion Grip™ Screwdriver Set	12

6 PCS CUSHION GRIP™ SCREWDRIVER SET

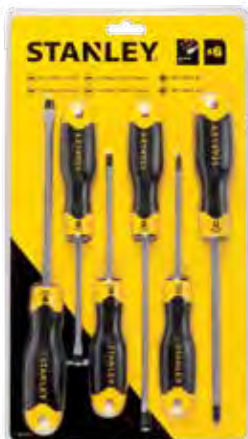

- Phillips® PH1 x 100mm
- Phillips® PH2 x 150mm
- Std Parallel 5mm x 100mm
- Std Parallel 5mm x 150mm
- Slotted 6.5mm x 150mm
- Slotted 5mm x 100mm

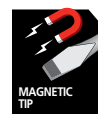

SKU #	Description	Box Qty
STHT65242-8	6 PCS Cushion Grip™ Screwdriver Set	12

4 PCS CUSHION GRIP™ SCREWDRIVER SET

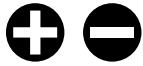

- Phillips® PH1 x 100mm
- Phillips® PH2 x 150mm
- Std Parallel 5mm x 100mm
- Slotted 6.5mm x 150mm

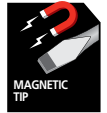

SKU #	Description	Box Qty
STHT65199-8	4 PCS Cushion Grip™ Screwdriver Set	24

2 PCS CUSHION GRIP™ SCREWDRIVER SET

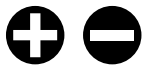

- Phillips® PH2 x 100mm
- Slotted 6.5mm x 100mm

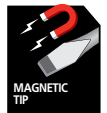

SKU #	Description	Box Qty
STHT65200-8	2 PCS Cushion Grip™ Screwdriver Set	24

5 PCS CUSHION GRIP™ TORX SCREWDRIVER SET

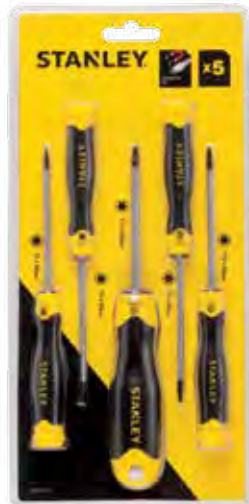

- T5, T6, T8, T10, T15 x 80mm

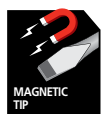

SKU #	Description	BoxQty
STHT65155-8	5 PCS Cushion Grip™ TORX Screwdriver Set	12

6 PCS CUSHION GRIP™ TORX SCREWDRIVER SET



- T10, T15, x 80mm
- T20, T25, T30, T40 x 120mm



SKU #	Description	Box Qty
STHT65156-8	6 PCS Cushion Grip™ TORX Screwdriver Set	12

8 PCS SCREWDRIVERS MODULE



COMPATIBLE with
TRANS
MODULE
system

- Cushion grip standard 3mm X 100mm
- Cushion grip standard parallel 5mm X 150mm
- Cushion grip standard 6.5mm X 150mm
- Cushion grip standard 8mm X 200mm
- Cushion grip phillips PH0 X 60mm
- Cushion grip phillips PH1 X 100mm
- Cushion grip phillips PH2 X 125mm
- Cushion grip phillips PH3 X 150mm

SKU #	Description	Length (mm)	Width (mm)	Height (mm)	Carton Qty
STMT74181-8	8 PCS Screwdrivers Module	384	184	45	4

6 PCS TORX SCREWDRIVERS MODULE



COMPATIBLE with
TRANS
MODULE
system

- Cushion grip torx T10 X 80mm
- Cushion grip torx T15 X 80mm
- Cushion grip torx T20 X 120mm
- Cushion grip torx T25 X 120mm
- Cushion grip torx T30 X 120mm
- Cushion grip torx T40 X 120mm

SKU #	Description	Length (mm)	Width (mm)	Height (mm)	Carton Qty
STMT74182-8	6 PCS Torx Screwdrivers Module	384	184	45	4

PVC HANDLE SCREWDRIVER RANGE OVERVIEW



PHILLIPS®

Tip Size	Bar Length (mm)	Total Length (mm)
PH0	75	139
	100	164
PH1	38	89
	75	164
	100	189
	150	239
PH2	250	339
	38	89
	100	206
PH3	150	256
	200	306
	250	356
PH4	150	277
PH4	200	384



SLOTTED FLARED

Tip Size	Bar Length (mm)	Total Length (mm)
3.2mm	50	114
	75	139
	100	164
	150	214
3.5mm	200	264
	250	314
5mm	75	164
	100	189
	150	239
	200	289
6mm	250	339
	300	389
	38	89
8mm	75	181
	100	206
	150	256
8mm	150	277
	250	377



TORX

Tip Size	Bar Length (mm)	Total Length (mm)
T10	100	246
T15		
T20		
T25		
T30		

TACK CLAW

Tip Size	Tip Size	Total Length (mm)
6mm	100	263

PVC HANDLE PHILLIPS®

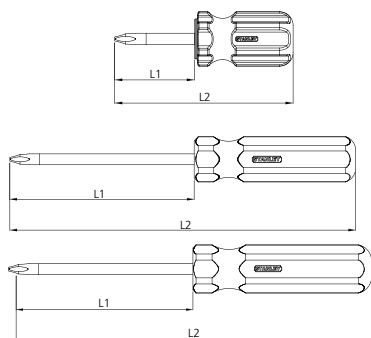

- Comfortable handle
- Chrome plated Cr-V bar resists corrosion
- Magnetic tips for secure grip on fasteners
- Color coordinated handles: red (standard), blue (Phillips®), black (Torx)



Retail SKU #	Bulk SKU #	Description	Tip Size	L1 (mm)	L2 (mm)	Box Qty
STHT69138-8	STHT69138-8B	PVC Handle PH0 X 75mm	PH0	75	139	12
STHT69177-8	STHT69177-8B	PVC Handle PH0 X 100mm	PH0	100	164	12
STHT69139-8	STHT69139-8B	PVC Handle PH1 X 38mm	PH1	38	89	12
STHT69178-8	STHT69178-8B	PVC Handle PH1 X 75mm	PH1	75	164	12
STHT69141-8	STHT69141-8B	PVC Handle PH1 X 100mm	PH1	100	189	12
STHT69179-8	STHT69179-8B	PVC Handle PH1 X 150mm	PH1	150	239	12
STHT69142-8	STHT69142-8B	PVC Handle PH1 X 250mm	PH1	250	339	12
STHT69144-8	STHT69144-8B	PVC Handle PH2 X 38mm	PH2	38	89	12
STHT69145-8	STHT69145-8B	PVC Handle PH2 X 100mm	PH2	100	206	12
STHT69180-8	STHT69180-8B	PVC Handle PH2 X 150mm	PH2	150	256	12
STHT69146-8	STHT69146-8B	PVC Handle PH2 X 200mm	PH2	200	306	12
STHT69147-8	STHT69147-8B	PVC Handle PH2 X 250mm	PH2	250	356	12
STHT69148-8	STHT69148-8B	PVC Handle PH3 X 150mm	PH3	150	277	6
STHT69150-8	-	PVC Handle PH4 X 200mm	PH4	200	384	6

PVC HANDLE SLOTTED FLARED

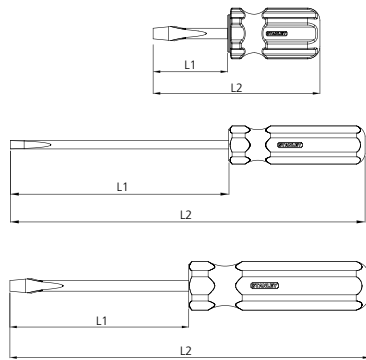

- Comfortable handle
- Chrome plated Cr-V bar resists corrosion
- Magnetic tips for secure grip on fasteners
- Color coordinated handles: red (standard), blue (Phillips®), black (Torx)

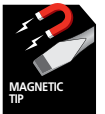

Retail SKU #	Bulk SKU #	Description	Tip Size	L1 (mm)	L2 (mm)	Box Qty
STHT69102-8	STHT69102-8B	PVC Handle Standard 3.2mm X 50mm	3.2mm	50	114	12
STHT69103-8	STHT69103-8B	PVC Handle Standard 3.2mm X 75mm	3.2mm	75	139	12
STHT69104-8	STHT69104-8B	PVC Handle Standard 3.2mm X 100mm	3.2mm	100	164	12
STHT69106-8	STHT69106-8B	PVC Handle Standard 3.2mm X 150mm	3.2mm	150	214	12
STHT69107-8	STHT69107-8B	PVC Handle Standard 3.2mm X 200mm	3.2mm	200	264	12
STHT69108-8	STHT69108-8B	PVC Handle Standard 3.5mm X 250mm	3.5mm	250	314	12
STHT69109-8	STHT69109-8B	PVC Handle Standard 5mm X 75mm	5mm	75	164	12
STHT69111-8	STHT69111-8B	PVC Handle Standard 5mm X 100mm	5mm	100	189	12
STHT69112-8	STHT69112-8B	PVC Handle Standard 5mm X 150mm	5mm	150	239	12
STHT69113-8	STHT69113-8B	PVC Handle Standard 5mm X 200mm	5mm	200	289	12
STHT69114-8	STHT69114-8B	PVC Handle Standard 5mm X 250mm	5mm	250	339	12
STHT69116-8	STHT69116-8B	PVC Handle Standard 5mm X 300mm	5mm	300	389	12
STHT69118-8	STHT69118-8B	PVC Handle Standard 6mm X 38mm	6mm	38	89	12
STHT69101-8	STHT69101-8B	PVC Handle Standard 6mm X 75mm	6mm	75	181	12
-	STHT69119-8B	PVC Handle Standard 6mm X 100mm	6mm	100	206	12
-	STHT69120-8B	PVC Handle Standard 6mm X 150mm	6mm	150	256	12
STHT69121-8	STHT69121-8B	PVC Handle Standard 8mm X 150mm	8mm	150	277	6
STHT69175-8	STHT69175-8B	PVC Handle Standard 8mm X 250mm	8mm	250	377	6

PVC HANDLE TORX

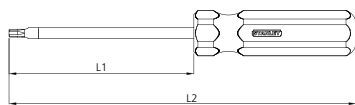

- Comfortable handle
- Chrome plated Cr-V bar resists corrosion
- Magnetic tips for secure grip on fasteners
- Color coordinated handles: red (standard), blue (Phillips®), black (Torx)

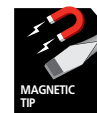

SKU #	Description	Tip Size	L1 (mm)	L2 (mm)	Box Qty
STHT69162-8	PVC Handle TORX T10 X 100mm	T10	100	246	12
STHT69163-8	PVC Handle TORX T15 X 100mm	T15	100	246	12
STHT69164-8	PVC Handle TORX T20 X 100mm	T20	100	246	12
STHT69166-8	PVC Handle TORX T25 X 100mm	T25	100	246	12
STHT69167-8	PVC Handle TORX T30 X 100mm	T30	100	246	12

PVC HANDLE TACK CLAW

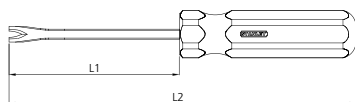

- Comfortable handle
- Chrome plated Cr-V bar resists corrosion
- Ideal for nail pulling



SKU #	Description	Tip Size	L1 (mm)	L2 (mm)	Box Qty
STHT69168-8	PVC Handle 6mm X 100mm	6mm	100	263	12

VDE SCREWDRIVER PHILLIPS®



- Insulation directly injection-moulded around the blade
- Ergonomic, shock resistant, anti slip handle and for greater torque to be applied with less effort
- Each screwdriver is individually tested to 10,000V in a water bath for 10 SCEa

SKU #	Description	Tip Size	L1 (mm)	Length (mm)	Box Qty
STHT65972-8	VDE Screwdriver PH0 X 60mm	PH0	60	160	12
STHT65973-8	VDE Screwdriver PH1 X 80mm	PH1	80	190	12
STHT65974-8	VDE Screwdriver PH2 X 100mm	PH2	100	215	12
STHT65975-8	VDE Screwdriver PH3 X 150mm	PH3	150	275	12

VDE SCREWDRIVER SLOTTED FLARED



- Insulation directly injection-moulded around the blade
- Ergonomic, shock resistant, anti slip handle and for greater torque to be applied with less effort
- Each screwdriver is individually tested to 10,000V in a water bath for 10 SCEa

SKU #	Description	Tip Size	L1 (mm)	Length (mm)	Box Qty
STHT65966-8	VDE Screwdriver Standard 3.0x100mm	3.0	100	200	12
STHT65967-8	VDE Screwdriver Standard 4.0x100mm	4.0	100	200	12
STHT65968-8	VDE Screwdriver Standard 5.5x125mm	5.5	125	235	12
STHT65969-8	VDE Screwdriver Standard 6.5x150mm	6.5	150	265	12
STHT65970-8	VDE Screwdriver Standard 8.0x175mm	8.0	175	300	12
STHT65971-8	VDE Screwdriver Standard 10.0x200mm	10	200	325	12

7 PCS VDE SCREWDRIVER SET



3.0 x 100mm
4.0 x 100mm
5.5 x 125mm
6.5 x 150mm



3.0 x 70mm



PH1 x 80mm
PH2 x 100mm



- Insulation directly injection-moulded around the blade
- Ergonomic, shock resistant, anti slip handle and for greater torque to be applied with less effort
- Each screwdriver is individually tested to 10,000V in a water bath for 10 SCEa



SKU #	Description
STHT65980-8	7 PCS VDE Screwdriver Set

SPARK DETECTING SCREWDRIVER

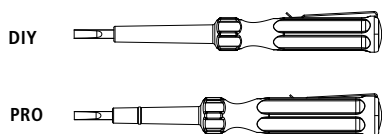

STHT72991-8

STHT72992-8

Retail SKU #	Bulk SKU #	Description	Tip Size	Length (mm)	Box Qty
STHT72991-8	STHT72991-8B	Stanley Tester - DIY	3.5	128	20
STHT72992-8	STHT72992-8B	Stanley Tester - PRO	3.5	133	20

SPARK DETECTING SCREWDRIVER



- Test range of 100~500V
- Pocket size model c/w clip
- Attractive PP card packaging

SKU#	Blade Length		O/A Length		Tip Width		Box/CTN
	mm	inches	mm	inches	mm	inches	
66-119-S	50	2-3/4"	127	5-1/2"	3	1/8"	20/600
66-120-S	100	4"	178	7-1/2"	5	3/16"	20/480

MULTIFUNCTIONAL DIGITAL TESTER WITH LCD DISPLAY AND NEON LAMP DISPLAY



- Easy single button operation
- Easy to read & practical screen
- Ergonomic design & shape , Bi-Material body combination
- Pocket clip for easy carrying
- Neon lamp for electriciferous test
- International standard, CE certified
- Rubber hands provides comfort & insulation

SKU#	Description	Box/CTN
66-133	Multifunctional Digital Tester with LCD Display and Neon Lamp Display	12/96

MULTIFUNCTIONAL DIGITAL TESTER WITH LCD DISPLAY



Induction test, break-point & voltage reading button

- Easy to read & practical screen
- Pocket clip for easy carrying
- International standard, CE certified
- Longer tip for deep insertion

SKU#	Description	Box/CTN
66-137-S	Multifunctional Digital Tester with LCD Display	12/240

10 PCS RATCHETING MULTIBIT SCREWDRIVER

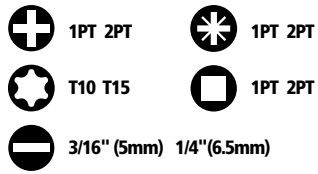

- Three-position switch enables clockwise and counter-clockwise ratcheting and locked position
- Bit storage in handle for quick and easy access
- Ergonomically designed handle
- Magnetic bit holder for speedy and secure changeover of bits
- Includes: 3/16" Standard, 1/4" Standard, 1pt Phillips®, 2pt Phillips®, T15 Torx, T20 Torx, 1pt Pozi, 2pt Pozi, 1pt Square, 2pt Square, Storage Rack



SKU #	Description	Box Qty
STHT68010-8	10 PCS Ratcheting Multibit Screwdriver	2

6-WAY SCREWDRIVER





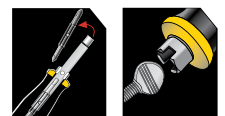



- Convenient and space-saving design reduces the number of tools users must carry
- Chrome-plated bar resists corrosion
- Slip-resistant rubber grip provides comfort



SKU #	Description	Box Qty
STHT68012-8	6-Way Screwdriver	6

6 PCS STUBBY MULTIBIT SCREWDRIVER







-  1PT
-  2PT
-  4.5mm
-  6.0mm
-  1PT
-  2PT

- Magnetic bit holder for speedy and secure changeover of bits
- Durable bi-material handles with comfrot grip
- Includes (6) CR-V bits with internal bit storage for easy access to bits-end cap carries 6 bits



SKU #	Description	Box Qty
STHT66357-8	6 PCS Stubby Multibit Screwdrivers	3

6 PCS RATCHETING STUBBY MULTIBIT SCREWDRIVER

-  1PT
-  2PT
-  4.5mm
-  6.0mm
-  1PT
-  2PT

- Three-position switch enables clockwise and counter-clockwise ratcheting and locked position
- Magnetic bit holder for speedy and secure changeover of bits
- Durable bi-material handles with comfrot grip
- Includes (6) CR-V bits with internal bit storage for easy access to bits-end cap carries 6 bits



SKU #	Description	Box Qty
STHT66358-8	6 PCS Ratcheting Stubby Multibit Screwdrivers	3

9-WAY SCREWDRIVER

 OPT 1PT 2PT

 1/8" (3mm) 3/16" (5mm) 1/4" (6mm)



- Interchangeable bars maximize versatility
- Reduces the number of tools user needs to carry
- Storage case included
- Includes: 1/8" Standard Bar, 3/16" Standard Bar, 1/4" Standard Bar, Opt Phillips® Bar, 1pt Phillips® Bar, 2pt Phillips® Bar, 1 Tack Puller, 1 Brad Awl, 1 Hook Driver



SKU #	Description	Box Qty
STHT62511-8	9-Way Screwdriver	6

10-WAY FLEXIBLE SCREWDRIVER

 1PT 2PT

 1PT 2PT

 T15 T20

 3/16" (5mm)
1/4" (6.5mm)
9/32" (7mm)

- 10 Replaceable 1/4" bits and adapter
- Comfortable bi-material handle
- Bit magazine with belt clip

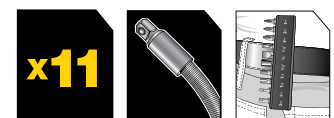

SKU #	Description	Box Qty
STHT62508-8	10-Way Flexible Screwdriver	4

6 PCS METAL PRECISION SCREWDRIVER SET

+ OPT 1PT

— 1.4mm 2.0mm
2.4mm 3.0mm

- Swivel-head handles provide tightening precisely
- Bright, plated shafts are fluted for a steady, solid grip
- Hardened and tempered steel blades with blued finish to resist corrosion
- Plastic storage case included

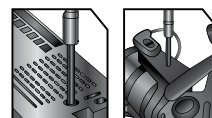

x6



Metal Handle

SKU #	Description	Box Qty
STHT66039-8	6 PCS Precision Screwdriver Set	12

6 PCS BI-MAT PRECISION SCREWDRIVER SET

+ OPT 1PT

— 1.4mm 2.0mm
2.4mm 3.0mm

- Swivel-head handles provide tightening precisely
- Tough, plastic handles with soft cushion grip for comfort
- Plastic storage case included

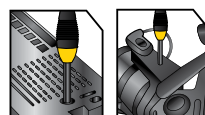



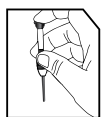



x6



Plastic Handle

SKU #	Description	Box Qty
STHT66052-8	6 PCS Bi-Mat Precision Screwdriver Set	6

6.3MM BITS OVERVIEW

TYPE		TIP	Length (mm)					
			25	50	60	65	110	
Single End	 Slotted	5 mm		•				
		5.5 mm		•				
		6 mm		•				
		6.5 mm		•				
	 Phillips®	PH0		•				
		PH1		•				
		PH2	•	•				
		PH3		•				
	 Torx	T10		•				
		T15		•				
		T20		•				
		T25		•				
	 Pozidriv	PZ2	•	•				
	Double End	 Phillips®	PH1-PH1				•	•
			PH2-PH2				•	•
			PH3-PH3				•	•
PH1-PH2						•		
PH2-PH3						•		
 Slotted-Phillips®		4.5mm-PH1				•		
		5.5mm-PH2				•		
		6.5mm-PH3				•		
Bit Holder					•			

6.3MM SLOTTED HEADS



- Ideal for screwing
- Tempered for durability

SKU #	Description	Tip Size	Length (mm)	Box Qty
63-013T-23	5.0mm X 50mm	5.0mm	50	10
63-014T-23	5.5mm X 50mm	5.5mm	50	10
63-015T-23	6.0mm X 50mm	6.0mm	50	10
63-016T-23	6.5mm X 50mm	6.5mm	50	10

6.3MM PHILLIPS® HEADS



- Ideal for screwing
- Tempered for durability

SKU #	Description	Tip Size	Length (mm)	Box Qty
63-026T-23	PH0 X 50mm	PH0	50	10
63-027T-23	PH1 X 50mm	PH1	50	10
63-028T-23	PH2 X 50mm	PH2	50	10
63-029T-23	PH3 X 50mm	PH3	50	10

6.3MM TORX HEADS

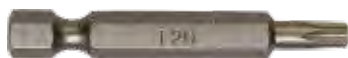

- Ideal for screwing
- Tempered for durability

SKU #	Description	Tip Size	Length (mm)	Box Qty
63-054T-23	T10 X 50mm	T10	50	10
63-055T-23	T15 X 50mm	T15	50	10
63-056T-23	T20 X 50mm	T20	50	10
63-057T-23	T25 X 50mm	T25	50	10

6.3MM PHILLIPS® HEADS

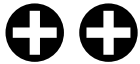

- Economical double ended tips
- Ideal for screwing
- Tempered for durability

SKU #	Description	Tip Size	Length (mm)	Box Qty
63-101T-23	PH1-PH1 X 65mm	PH1-PH1	65	10
63-102T-23	PH2-PH2 X 65mm	PH2-PH2	65	10
63-103T-23	PH3-PH3 X 65mm	PH3-PH3	65	10

6.3MM SLOTTED-PHILLIPS® HEADS



- Mixed tip for easy usage
- Ideal for screwing
- Tempered for durability

SKU #	Description	Tip Size	Length (mm)	Box Qty
63-104T-23	4.5mm-PH1 X 65mm	4.5mm-PH1	65	10
63-105T-23	5.5mm-PH2 X 65mm	5.5mm-PH2	65	10
63-106T-23	6.5mm-PH3 X 65mm	6.5mm-PH3	65	10

6.3MM PHILLIPS® HEADS

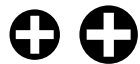

- Mixed tip for easy usage
- Tempered for durability

SKU #	Description	Tip Size	Length (mm)	Box Qty
63-107T-23	PH1-PH2 X 65mm	PH1-PH2	65	10
63-108T-23	PH2-PH3 X 65mm	PH2-PH3	65	10

6.3MM PHILLIPS® HEADS



- Economical double ended tips
- Ideal for screwing
- Tempered for durability

SKU #	Description	Tip Size	Length (mm)	Box Qty
63-111F-23	PH1-PH1 X 110mm	PH1-PH1	110	5
63-112F-23	PH2-PH2 X 110mm	PH2-PH2	110	5
63-113F-23	PH3-PH3 X 110mm	PH3-PH3	110	5

MAGNETIC BIT HOLDER



- Quick bit change
- Magnet holds fastener on bit

SKU #	Description	Length (mm)	Box Qty
63-189-23	6.3mm X 80mm	60	8

BITS MERCHANDISER



A Merchandiser with 20 Tic-tac Boxes



The merchandiser can be converted as a great display

- ISO 1173, ISO 2380-1, ISO 2351-1
- S2 Steel, 20% higher torque vs Cr-V
- HRC 60

SKU #	# of Bits / Tic-tac Box	# of Bits / Merchandiser
STHT72680-8L	25PCS	500PCS
STHT72678-8L	15PCS	300PCS
STHT72681-8L	25PCS	500PCS
STHT72679-8L	15PCS	300PCS



SKU #	Description	Tip Size	L (mm)	W (mm)	H (mm)	Weight (kg)	Carton Qty
STHT72680-8L	STANLEY® PH2 25mm Bits Merchandiser	PH2	245	155	75	3.15	4
STHT72678-8L	STANLEY® PH2 50mm Bits Merchandiser	PH2	245	155	80	4.04	4
STHT72681-8L	STANLEY® PZ2 25mm Bits Merchandiser	PZ2	245	155	75	3.22	4
STHT72679-8L	STANLEY® PZ2 50mm Bits Merchandiser	PZ2	245	155	75	4.05	4

MAXSTEEL™ C-CLAMP



- High-visibility, corrosion-resistant finish
- Advanced frame design resists flexing and bending
- Heavy-duty, malleable iron and steel construction
- Roll-formed screw threads ensure smooth operation and durability
- Oversized "T" handle for extra torque

SKU#	Length		Box/CTN
	mm	inches	
83-033K	57 x 75	3" x 2-1/4"	6/36
83-034K	75 x 100	4" x 3"	6/24
83-035K	89 x 150	6" x 3-1/2"	6/12
83-036K	100 x 200	8" x 4"	3/6

QUALITY MATERIALS FOR HIGH PERFORMANCE

PROFESSIONAL HEX RANGE

Attentively engineered, the **STANLEY®** Hex Key range comes conveniently grouped into sets or as multiples of the same size for common tasks. Hex or Torx drive options are perfectly suited to typical repair and maintenance situations.

Manufactured from S2 grade steel with a choice of short or long variants, spherical head options and up to 25° work angles, you can be sure that these ANSI certified products will live up to expectations.



S2
S2 Steel
material

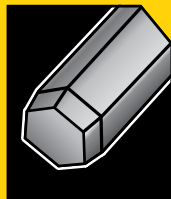

Hex Head

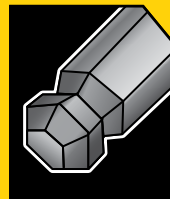

Spherical Head
Allows for 25°
working angle



Torx Head



HEX KEY RANGE OVERVIEW

SKU #	Description	No. of pieces	Sizes (mm/inch)	Length (mm)	Width (mm)	Weight (kg)	Qty
STMT94162-8	9 PCS Long Spheric-head Hex Key Set	9	1.5, 2, 2.5, 3, 4, 5, 6, 8, 10 mm	-	-	0.383	6
STMT92619-8	9 PCS Long Hex Key Set	9	1.5, 2, 2.5, 3, 4, 5, 6, 8, 10 mm	-	-	0.394	6
STMT92625-8	9 PCS Long Torx key set (T10 to T50)	9	TT10, TT15, TT20, TT25, TT27, TT30, TT40, TT45, TT50 mm	-	-	0.33	6
STMT94551-8	7 PCS Short Spher head Hex Key Set	7	1.5, 2, 2.5, 3, 4, 5, 6 mm	-	-	0.078	10
STMT69213-8	10 PCS Hex Key Ring Set	10	1.5, 2, 2.5, 3, 4, 5, 5.5, 6, 8, 10 mm	-	-	0.28	12
69-119	Hex Key Set 9pc Chrome MM	9	1.5, 2, 2.5, 3, 4, 5, 6, 8, 10mm	-	-	-	6
69-213	Hex Key Set 10pc Ring MM	10	1.5, 2, 2.5, 3, 4, 5, 5.5, 6, 8, 10mm	-	-	-	12
69-230	Hex Key Set 10pc Ring IMP	10	1/16, 5/64, 3/32, 1/8, 5/32, 3/16, 7/32, 1/4, 5/16, 3/8"	-	-	-	12
69-251	Hex Key Set 8pc S/arm MM	8	1, 1.5, 2, 2.5, 3, 4, 5, 5.5, 6mm	-	-	-	12
69-252	Hex Key Set 8pc S/arm IMP	8	1/16, 5/64, 3/32, 1/8, 5/32, 3/16, 7/32, 1/4"	-	-	-	12
69-253	Hex Key Set 10pc S/arm MM	10	1.5, 2, 2.5, 3, 4, 5, 5.5, 6, 8, 10mm	-	-	-	12
69-254	Hex Key Set 10pc S/arm IMP	10	1/16, 5/64, 3/32, 1/8, 5/32, 3/16, 7/32, 1/4, 5/16, 3/8"	-	-	-	12
69-256	Hex Key Set 9pc L/arm MM	9	1.5, 2, 2.5, 3, 4, 5, 6, 8, 10 mm	-	-	-	6
69-257	Hex Key Set 12pc L/arm IMP	12	1/16, 5/64, 3/32, 7/64, 1/8, 9/64, 5/32, 3/16, 7/32, 1/4, 5/16, 3/8"	-	-	-	6
69-259	Hex Key Set 9pc Fldg IMP	9	5/64, 3/32, 7/64, 1/8, 9/64, 5/32, 3/16, 7/32, 1/4"	-	-	-	12
69-260	Hex Key Set 5pc Fldg IMP	5	3/16, 7/32, 1/4, 5/16, 3/8"	-	-	-	12
69-261	Hex Key Set 7pc Fldg MM	7	1.5, 2, 2.5, 3, 4, 5, 6 mm	-	-	-	12
69-262	Hex Key Set 7pc Fldg MM	7	1.5, 2, 2.5, 3, 4, 5, 6 mm	-	-	-	12
STMT69213-8	10 PCS Hex Key Ring Set	10	1.5, 2, 2.5, 3, 4, 5, 5.5, 6, 8, 10 mm	-	-	0.28	12
STMT94099-8	Long Spherical Hex Key 1.5mm	6	1.5	187	55	0.016	72
STMT94100-8	Long Spherical Hex Key 2mm	6	2	187	55	0.022	72
STMT94101-8	Long Spherical Hex Key 2.5mm	6	2.5	187	55	0.033	72
STMT94102-8	Long Spherical Hex Key 3mm	6	3	187	55	0.05	72
STMT94103-8	Long Spherical Hex Key 4mm	6	4	269	81	0.096	72
STMT94104-8	Long Spherical Hex Key 5mm	6	5	269	81	0.157	72
STMT94106-8	Long Spherical Hex Key 6mm	6	6	269	81	0.258	72
STMT94108-8	Long Spherical Hex Key 8mm	6	8	302	102	0.524	72
STMT94109-8	Long Spherical Hex Key 10mm	3	10	302	102	0.441	36

9 PCS LONG SPHERICAL-HEAD HEX KEY SET



- ANSI B18.3.2M-1979 ,GGG-K-275D
- S2 steel
- Spherical head gives a working angle of up to 25°
- HRC 60 +/- 2, increase 20% torque than Cr-V
- Fine satin finish

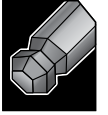

SKU #	Description	Qty	Size	Weight	Box Qty
STMT94162-8	9 PCS Long Spherical-head Hex Key Set	9	1.5, 2, 2.5, 3, 4, 5, 6, 8, 10 (mm)	0.383	6

9 PCS LONG HEX KEY SET



- ANSI B18.3.2M-1979 ,GGG-K-275D
- S2 steel
- HRC 60 +/- 2, increase 20% torque than Cr-V
- Fine satin finish

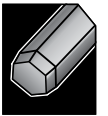

SKU #	Description	Qty	Size	Weight	Box Qty
STMT92619-8	9 PCS Long Hex Key Set	9	1.5, 2, 2.5, 3, 4, 5, 6, 8, 10 (mm)	0.394	6

9 PCS LONG TORX KEY SET



- ANSI B18.3.2M-1979 ,GGG-K-275D
- S2 steel
- HRC 60 +/- 2, increase 20% torque than Cr-V
- Fine satin finish



SKU #	Description	Qty	Size	Weight	Box Qty
STMT92625-8	9 PCS Long Torx Key Set (T10 to T50)	9	TT10, TT15, TT20, TT25, TT27, TT30, TT40, TT45, TT50	0.33	6

7 PCS SHORT SPHERICAL-HEAD HEAD HEX KEY SET



- ANSI B18.3.2M-1979 ,GGG-K-275D
- S2 steel
- Spherical head gives a working angle of up to 25°
- HRC 60 +/- 2, increase 20% torque than Cr-V
- Fine satin finish

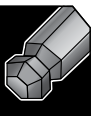

SKU #	Description	Qty	Size	Weight	Box Qty
STMT94551-8	7 PCS Short Spherical-head Hex Key Set	7	1.5, 2, 2.5, 3, 4, 5, 6 (mm)	0.078	10

HEX KEY SET



SKU #	Description	Contents	Box/CTN
69-119	Hex Key Set 9pc Chrome MM	1.5/2/2.5/3/4/5/6/8/10 mm – Ball tips	6/36
69-213	Hex Key Set 10pc Ring MM	1.5/2/2.5/3/4/5/5.5/6/8/10 mm	12/72
69-230	Hex Key Set 10pc Ring IMP	1/16, 5/64, 3/32, 1/8, 5/32, 3/16, 7/32, 1/4, 5/16, 3/8"	12/72
69-251	Hex Key Set 8pc S/arm MM	1.0/1.5/2/2.5/3/4/5/5.5/6 mm	12/72
69-252	Hex Key Set 8pc S/arm IMP	1/16, 5/64, 3/32, 1/8, 5/32, 3/16, 7/32, 1/4"	12/72
69-253	Hex Key Set 10pc S/arm MM	1.5/2/2.5/3/4/5/5.5/6/8/10 mm	12/72
69-254	Hex Key Set 10pc S/arm IMP	1/16, 5/64, 3/32, 1/8, 5/32, 3/16, 7/32, 1/4, 5/16, 3/8"	12/72
69-256	Hex Key Set 9pc L/arm MM	1.5/2/2.5/3/4/5/6/8/10 mm – Ball tips	6/36
69-257	Hex Key Set 12pc L/arm IMP	1/16, 5/64, 3/32, 7/64, 1/8, 9/64, 5/32, 3/16, 7/32, 1/4, 5/16, 3/8" – Ball tips	6/36
69-259	Hex Key Set 9pc Fldg IMP	5/64, 3/32, 7/64, 1/8, 9/64, 5/32, 3/16, 7/32, 1/4"	12/72
69-260	Hex Key Set 5pc Fldg IMP	3/16, 7/32, 1/4, 5/16, 3/8	12/48
69-261	Hex Key Set 7pc Fldg MM	1.5/2/2.5/3/4/5/6 mm	12/72
69-262	Hex Key Set 7pc Fldg MM	1.5/2/2.5/3/4/5/6 mm	12/72
69-263	Hex Key Set 8pc Fldg Torx®	T9/ T10/ T15 / T20/ T25/ T27 / T30/ T40	12/72
STMT69213-8	10 PCS Hex Key Ring Set	1.5, 2, 2.5, 3, 4, 5, 5.5, 6, 8, 10 (mm)	12

LONG SPHERICAL HEX KEY

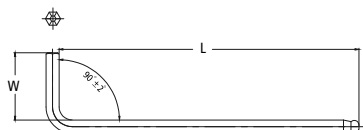

- ANSI B18.3.2M-1979 ,GGG-K-275D
- S2 steel
- Spherical head gives a working angle of up to 25°
- HRC 60 +/- 2, increase 20% torque than Cr-V
- Fine satin finish

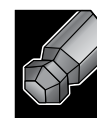

SKU #	Description	Qty	Size	Length (mm)	Width (mm)	Weight	Box Qty
STMT94099-8	Long Spherical Hex Key 1.5mm (6pcs)	6	1.5mm	187	55	0.016	72
STMT94100-8	Long Spherical Hex Key 2mm (6pcs)	6	2mm	187	55	0.022	72
STMT94101-8	Long Spherical Hex Key 2.5mm (6pcs)	6	2.5mm	187	55	0.033	72
STMT94102-8	Long Spherical Hex Key 3mm (6pcs)	6	3mm	187	55	0.05	72
STMT94103-8	Long Spherical Hex Key 4mm (6pcs)	6	4mm	269	81	0.096	72
STMT94104-8	Long Spherical Hex Key 5mm (6pcs)	6	5mm	269	81	0.157	72
STMT94106-8	Long Spherical Hex Key 6mm (6pcs)	6	6mm	269	81	0.258	72
STMT94108-8	Long Spherical Hex Key 8mm (6pcs)	6	8mm	302	102	0.524	72
STMT94109-8	Long Spherical Hex Key 10mm (3pcs)	3	10mm	302	102	0.441	36

SHARPSHOOTER™ STAPLE



- For light-duty household and crafting stapling jobs
- Colour-coded packaging makes size and product selection a cinch
- Sturdy plastic packaging reduces staple breakage
- Light-Duty - Narrow Crown - fits TR45 and Arrow® JT-21
- Heavy-Duty - Narrow Crown - fits TR110, TR200, TRE500 Series, PHT150, PHT250 and Arrow® T-50

SKU #	Description	Height		Pack Size	Box/CTN
		mm	inches		
TRA204T	1/4" Light-Duty Staples	6	1/4"	1,000 pcs	7/56
TRA205T	5/16" Light-Duty Staples	8	5/16"	1,000 pcs	6/48
TRA206T	3/8" Light-Duty Staples	10	3/8"	1,000 pcs	5/40
TRA704T	1/4" Heavy-Duty Staples	6	1/4"	1,000 pcs	7/56
TRA705T	5/16" Heavy-Duty Staples	8	5/16"	1,000 pcs	6/48
TRA706T	3/8" Heavy-Duty Staples	10	3/8"	1,000 pcs	5/40
TRA708T	1/2" Heavy-Duty Staples	12	1/2"	1,000 pcs	4/32
TRA709T	9/16" Heavy-Duty Staples	14	9/16"	1,000 pcs	4/32

LIGHT-DUTY STAPLE GUN



- Perfect for everyday stapling needs around the home or office
- Lightweight with convenient handle lock for safe storage
- Quick-jam-clear mechanism saves time and hassles
- Chrome-plated steel construction for durability

SKU #	Staple Used	Box/CTN
TR45	TRA200 or Arrow® JT-21® light-duty staples	40/720
TR110	SharpShooter® TRA700 or ArrowT-50® heavy-duty staples	1/3

HEAVY-DUTY STAPLE GUN



- Easy-squeeze handle reduces hand fatigue
- Anti-jam mechanism saves time on the job
- High-visibility yellow color easy to spot in a toolbox or workshop
- Durable aircraft-aluminum housing withstands heavy use
- Delivers high power and deep penetration
- Easy-slide full-stick staple load

SKU #	Staple Used	Box/CTN
TR150	SharpShooter® TRA700 or Arrow® T-50® heavy-duty staples	1/6

HEAVY-DUTY STAPLE GUN / BRAD NAILER



- Easy-squeeze product works overtime as a staple gun, brad-nailer, cable-tacker and wire-tacker
- All-metal drive channel ensures better penetration
- Less force to squeeze and more driving power
- Heavy-duty aircraft-aluminum housing for long-lasting durability
- Hi/Lo power lever for hard and soft materials
- Flush-nose design solves the problem of stapling in tight spots
- Lock-down handle for safe storage
- Quick-view window simplifies staple identification
- Easy-slide full-stick staple load

SKU #	Staple Used	Box/CTN
TR250	SharpShooter® TRA700 series or Arrow® T-50® heavy-duty narrow crown staples and 1/2", 9/16" and 5/8" Brads	1/6

GLUEPRO™ MINI HOT MELT GLUE GUN



- Small, portable size for quick gluing jobs in tight spaces
- Trigger-feed mechanism controls glue flow
- Uses GS10DT standard mini hot melt sticks
- Fold-out stand for safe, handy storage while in use

SKU #	Contents	Glue Stick	Box/CTN
69-GR10B	Mini Hot Melt Glue Gun 100-240V/15W Round Pin	GS10DT	6/36
69-GR10C	Mini Hot Melt Glue Gun 100-240V/15W Flat Pin	GS10DT	6/36

GLUEPRO™ MINI DUAL TEMP MELT GLUE GUN



- Ideal for hobbies, crafts and repairs
- Convenient, one-touch high/low selector switch
- Uses mini dual-temperature glue on both settings and mini hot-melt on high settings
- Fold-out stand for safe, handy storage while in use

SKU #	Contents	Glue Stick	Box/CTN
69-GR15B	Mini Dual Temp Glue Gun 100-240V/15W Round Pin	GS10DT	6/36
69-GR15C	Mini Dual Temp Glue Gun 100-240V/15W Flat Pin	GS10DT	6/36

GLUEPRO™ TRIGGER FEED HOT MELT GLUE GUN



- Quality engineered for reliable performance
- Trigger-feed mechanism controls glue flow
- Heats up quickly and bonds within 60 seconds
- Uses standard GS10DT hot melt glue sticks
- Fold-out stand for safe, handy storage while in use

SKU #	Contents	Glue Stick	Box/CTN
69-GR20B	Trigger Feed Hot Melt Glue Gun 100-240V/40W Round Pin	GS20DT/25DT/GS260 &500	6/24
69-GR20C	Trigger Feed Hot Melt Glue Gun 100-240V/40W Flat Pin	GS20DT/25DT/GS260 &500	6/24

GLUEPRO™ TRIGGER FEED DUAL MELT GLUE GUN



- Offers the versatility of high and low temperature gluing in one gun
- Convenient, one-touch high/low selector switch
- Uses standard dual-temperature glue on both settings and hot melt formulas on high setting
- Heats up quickly and bonds within 60 seconds
- Fold-out stand for safe, handy storage while in use

SKU #	Contents	Glue Stick	Box/CTN
69-GR25B	Trigger Feed Dual Melt Glue Gun 100-240V/80W Round Pin	GS20DT/25DT/GS260 &500	6/24
69-GR25C	Trigger Feed Dual Melt Glue Gun 100-240V/80W Flat Pin	GS20DT/25DT/GS260 &500	6/24

GLUEPRO™ CORD FREE 2-WAY GLUE GUN



- Versatile glue gun works with or without cord
- Cordless operation for up to 12 minutes
- Heats up quickly
- Fold-out stand for safe, handy storage while in use

SKU #	Contents	Glue Stick	Box/CTN
69-GR90B	Cord Free 2 Way Glue Gun 100-240V/40W Round Pin	GS20DT/25DT/GS260 &500	6/24
69-GR90C	Cord Free 2 Way Glue Gun 100-240V/40W Flat Pin	GS20DT/25DT/GS260 &500	6/24

SOLDERING IRON



- Suitable for soldering metals like copper, tin, brass and stained glass
- Working temperature reached in 2 minutes
- Slim pencil like handle for easy use and control

SKU #	Pin Head	Capacity	Box/CTN
69-031B	Round	30W/220V	20/80
69-031C	Flat	30W/220V	20/80
69-033B	Round	45W/220V	20/80
69-033C	Flat	45W/220V	20/80

SOLDERING GUN



- Suitable for soldering light gauge wires, thin metals and hobby work
- Reaches working temperature in 12 seconds
- Come with 2 soldering tips

SKU #	Contents	Pin Head	Box/CTN
69-041B	100W/220V Complete kit comprising: Soldering gun. Tip Solder	Round	6/24
69-041C	100W/220V Complete kit comprising: Soldering gun. Tip Solder	Flat	6/24

RIVETER



- Spring-loaded handle ejects rivet stem automatically
- Slim-nose design fits in difficult-to-reach places
- Long handle makes riveter easy to squeeze

SKU #	Description	Box Qty
STHT69646-8	Medium-duty riveter 3 nozzles for 1/8", 5/32", 3/16" rivets	6
STHT69800-8	Heavy-duty riveter 4 nozzles for 3/32", 1/8", 5/32", 3/16" rivets	6

STANLEY®

STRIKING TOOLS



Hammers

Soft Face Hammers

Pry Bars

Chisels





POUND NAILS NOT ARMS

HAMMERS

STANLEY® has offered the world a great selection of striking tools for over 150 years, securing its place as one of the world's premier makers of high quality hammers. Extensive tests for quality control are conducted on each product range, giving users the best in safety and efficiency. Major technological advances have been made, including striking accuracy, reduced arm torsion and decreased arm damaging vibrations.



PRY BARS

Whether you need something for heavy demolition work or something elegantly contoured for pulling, prying and lifting nails, all pry bars offered by **STANLEY®** are the strongest and most durable on the market.



CHISELS

STANLEY® began manufacturing chisels in the mid 1800's and has since made some of the most iconic wood chisels in the world. With an extensive range of cold chisels and wood chisels, **STANLEY®** chisels are ideal for cutting and shaping wrought iron, cast-iron, steel, copper, aluminum, bronze, bolts, nuts and rivets. The clever one-piece construction is forged for strength and tempered for long life. The tools' powder-coated finish makes it easy to spot, ensuring that safety comes first.



HAMMER OVERVIEW

PROFILE	HEAD MATERIAL	SPEC				
		WEIGHT (g)	WEIGHT (oz)	LENGTH (mm)	HANDLE	
Claw	Wood Handle Claw Hammer	Steel	195	7	290	Wood
			365	13	310	
			450	16	330	
			565	20	330	
	Fiberglass Claw Hammer	Steel	195	7	280	Fiberglass
			450	16	335	
565			20			
Steel Handle Claw Hammer	Steel	450	16	335	Steel/PE	
		565	20			
Ball Pein	Wood Handle Ball Pein Hammer	Steel	225	8	290	Wood
			340	12	295	
			450	16	345	
Soft Face	Rubber Mallet	Rubber	365	13	335	Wood
			450	16		
			565	20		
			680	24		
	Face Mallet	Steel/PU	-	-	280 305 325	Wood

TERMINOLOGY OF HAMMER

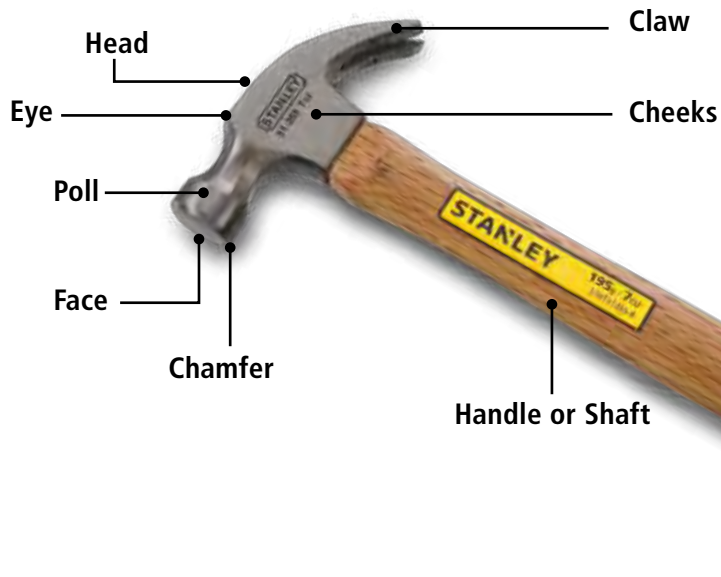

WOOD HANDLE CLAW HAMMER

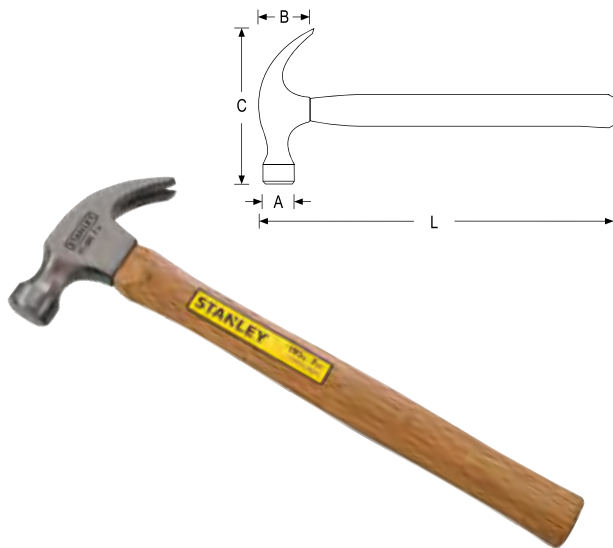

- Forged high-carbon steel head provides durability
- Fully heat-treated and polished bell face
- Lightweight wooden handle



SKU #	Description	L (mm)	Head Weight (oz)	Head Weight (g)	A (mm)	B (mm)	C (mm)	Type	Handle	Box Qty
STHT51265-8	7oz Wood Handle Nail Hammer	290	7oz	195	23	31	100	Claw	Wood	6
STHT51269-8	13oz Wood Handle Nail Hammer	310	13oz	365	27	45	123	Claw	Wood	6
STHT51271-8	16oz Wood Handle Nail Hammer	330	16oz	450	28	47	130	Claw	Wood	6
STHT51274-8	20oz Wood Handle Nail Hammer	330	20oz	565	30	49	134	Claw	Wood	6

FIBERGLASS CLAW HAMMER

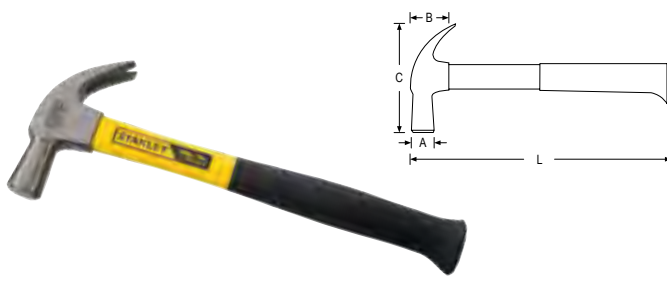

- Fiberglass core adds strength and durability to the handle
- Yellow-colored shaft for easy product visibility
- Exclusive rim temper reduces incidences of chipping or spalling

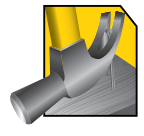

SKU #	Description	L (mm)	Head Weight (oz)	Head Weight (g)	A (mm)	B (mm)	C (mm)	Type	Handle	Box Qty
STHT51112-8	7oz Yellow Fiberglass Handle Nail Hammer	280	7oz	195	23	31	100	Claw	Fiberglass	6
STHT51071-8	16oz Yellow Fiberglass Handle Nail Hammer	335	16oz	450	28	47	130	Claw	Fiberglass	6
STHT51072-8	20oz Yellow Fiberglass Handle Nail Hammer	335	20oz	565	30	49	138	Claw	Fiberglass	6

STEEL HANDLE CLAW HAMMER

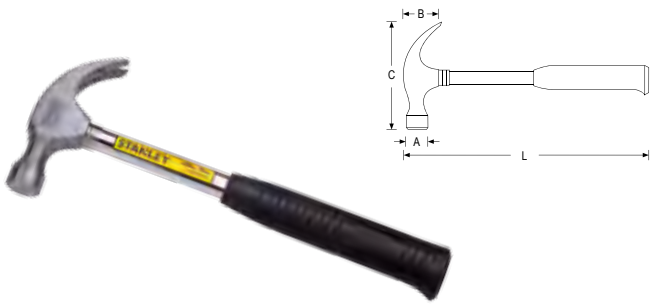

- Shaft 15% longer for better balance & control in usage
- Grip 15% longer for better performance
- Individually heat-treated for long life
- Hardened and tempered tubular steel shaft for strength
- Flock-filled rubber grip for comfort and durability
- Meets ANSI standards



SKU #	Description	L (mm)	Head Weight (oz)	Head Weight (g)	A (mm)	B (mm)	C (mm)	Type	Handle	Box Qty
STHT51081-8	16oz Steel Handle Claw Hammer	335	16	450	28	42	127	Claw	Steel	6
STHT51082-8	20oz Steel Handle Claw Hammer	335	20	565	30	45	138	Claw	Steel	6

JACKETED FIBERGLASS ENGINEERING HAMMER



- Heat treated high carbon alloy steel heads for long life and durability
- Machined striking face for accuracy
- Jacketed fiberglass handle for overstrike protection

SKU#	Head Length		Weight		Box/CTN
	mm	inches	grams	oz	
56-202	112	4-3/8"	1100	40	4/4
56-204	135	5-1/4"	1800	64	4/4

WOOD HANDLE BALL PEIN HAMMER

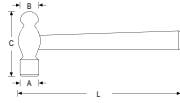

- Ball end used for riveting, and poll used for normal striking
- The hammer head is attached with two wedges for improved durability
- Exclusive rim temper reduces incidences of chipping or spalling

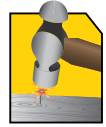

SKU #	Description	L (mm)	Head Weight (oz)	Head Weight (g)	A (mm)	B (mm)	C (mm)	Type	Handle	Box Qty
STHT54189-8	8oz Wood Handle Ball Pein Hammer	290	8	225	27	24	83	Ball Pein	Wood	6
STHT54190-8	12oz Wood Handle Ball Pein Hammer	295	12	340	30	25	91	Ball Pein	Wood	6
STHT54191-8	16oz Wood Handle Ball Pein Hammer	345	16	450	31	27	103	Ball Pein	Wood	6
54-192	24oz Wood handle Ball Pein Hammer	381	24	680	-	-	-	Ball Pein	Wood	6
54-193	32oz Wood handle Ball Pein Hammer	405	32	910	-	-	-	Ball Pein	Wood	6

CONTRACTOR GRADE HICKORY HANDLE ENG HAMMER



- Forged steel head-hardened and tempered
- Faces machine finished
- Selected clear lacquered hickory handle

SKU#	Head Length		Weight		Box/CTN
	mm	inches	grams	oz	
56-803	130	5-1/8"	1,400	50	4/4
56-804	135	5-1/4"	1,800	64	4/4

CONTRACTOR GRADE HICKORY HANDLE SLEDGE HAMMER



- Forged steel head-hardened and tempered
- Faces machine finished
- Selected clear lacquered hickory handle

SKU#	Head Length		Weight		Box/CTN
	mm	inches	grams	oz	
56-808	165	6-1/2"	3,600	127	4/4
56-812	195	7-3/4"	5,400	190	4/4
56-816	215	8-1/2"	7,300	258	2/2

RUBBER MALLET

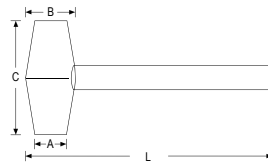

- Rubber head helps minimize marring and surface damage
- Tough rubber head molded to a wood handle



SKU #	Description	L (mm)	Head Weight (oz)	Head Weight (g)	A (mm)	B (mm)	C (mm)	Type	Handle	Box Qty
STHT57516-8	13oz Rubber Mallet	335	13	365	53	53	78	Rubber Mallet	Wood	6
STHT57527-8	16oz Rubber Mallet	335	16	450	55	55	92	Rubber Mallet	Wood	6
STHT57523-8	20oz Rubber Mallet	335	20	565	57	57	106	Rubber Mallet	Wood	6
STHT57528-8	24oz Rubber Mallet	335	24	680	60	60	112	Rubber Mallet	Wood	6

FACE MALLET

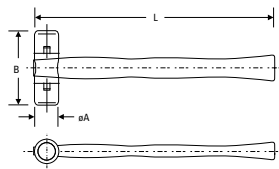

- Soft surface helps minimize marring and surface damage
- Faces are made of durable plastic that is ideal for fine finished surfaces
- Plastic faces are replaceable

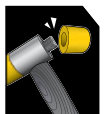

SKU #	Description	L (mm)	A (mm)	B (mm)	Type	Handle	Box Qty
STHT57055-8	28mm Face Mallet	280	28	82	Face Mallet	Wood	6
STHT57056-8	35mm Face Mallet	305	35	92	Face Mallet	Wood	6
STHT57057-8	45mm Face Mallet	325	45	105	Face Mallet	Wood	6

COMPO-CAST® STANDARD HEAD SOFT FACE HAMMER



- Non-Sparking soft face hammers
- No exposed metal
- Soft face doesn't mar surfaces or equipment
- Steel reinforced handles provide added strength and safety, resist breaking on overstrike

SKU#	Face Diam.		Head Length		O / A Length		Weight		Box/CTN
	mm	inches	mm	inches	mm	inches	grams	oz.	
57-530	30	1.2"	79	3-1/8"	257	10-1/8"	284	10	1/4
57-531	40	1.6"	95	3-3/4"	286	11-1/4"	510	18	1/4
57-532	45	1.8"	103	4-1/16"	327	12-7/8"	595	21	1/4
57-533	53	2.1"	117	4-5/8"	362	14-1/4"	1,191	42	4/4
57-534	63	2.5"	136	5-3/8"	387	15-1/4"	1,474	52	1/2

PRY BAR OVERVIEW

	MATERIAL	SPEC	
		Length (mm)	Weight (lbs)
Ripping Bar	High Carbon Steel	457	2.00
		597	3.70
		914	5.30
		762	4.50
Claw Bar	High Carbon Steel	203	0.50
		254	0.70
		305	1.00
Straight Bar	CR-V	1500	15

RIPPING BAR

- Ideal for basic demolition work
- Slotted claw and beveled ends for functionality and performance
- 3/4" diameter high-carbon steel

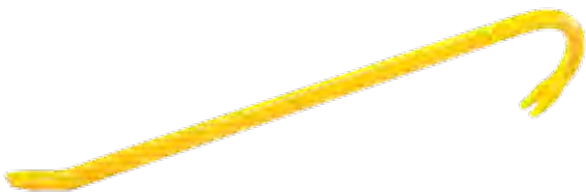

SKU #	Description	Length (mm)	Weight (lbs)	Box Qty
55-118	18" Forged Hexagonal Steel Ripping Bar	457	2.00	6
STHT55124-8	24" Forged Hexagonal Steel Ripping Bar	597	3.70	2
STHT55130-8	30" Forged Hexagonal Steel Ripping Bar	914	5.30	-
STHT55136-8	36" Forged Hexagonal Steel Ripping Bar	762	4.50	-

STANLEY®

CLAW BAR

STANLEY® Claw Bars are ideal for nail pulling and prying. This range features claw bars that are polished and have beveled claws for precise penetration. These claw bars are perfect for removing heavy duty nails.



SKU #	Description	Length (mm)	Weight (lbs)	Box Qty
55-113	8" Claw Bar	203	0.50	6
55-114	10" Claw Bar	254	0.70	2
55-115	12" Claw Bar	305	1.00	2

STRAIGHT BAR



- Basic tool used in demolition of all types of construction, including concrete

SKU #	Description	Length (mm)	Weight (lbs)	Box Qty
55-150	1.5m Hexagonal Straight Bar	1500	15	6

TERMINOLOGY OF CHISEL

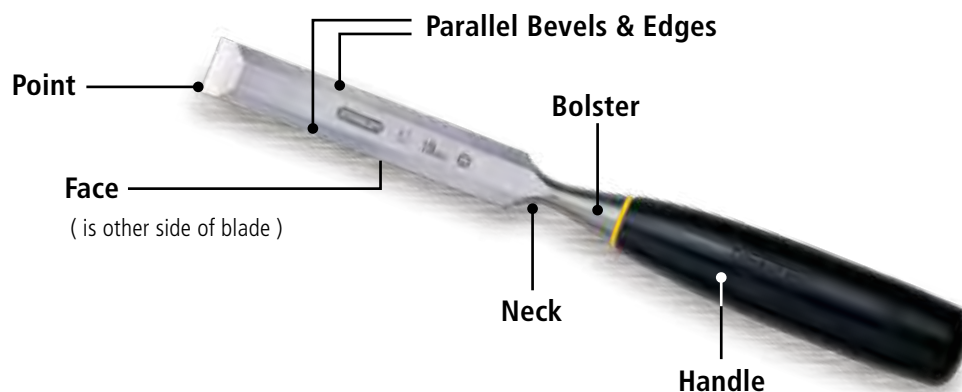

PRECISION REMOVAL AND PARING OF WOOD

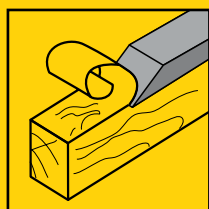

Cutting and carving

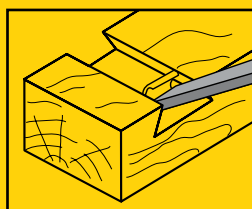

Dovetail joints

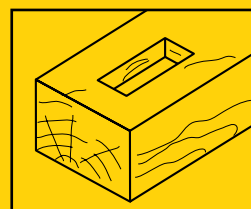

Mortise joints

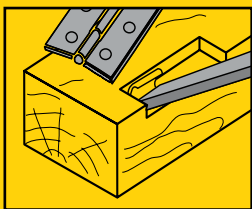

Mortise locks & hinges

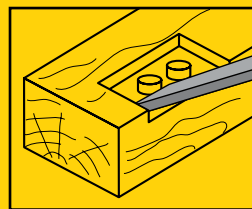

Trim dowels

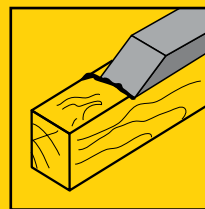

Remove excess glue

DYNAGRIP® CHISEL



- Blade guard for storage safety
- Fully precision ground blade on all faces
- Ergonomic hi-impact resistant bi-material handle
- Rust-resistant, lacquered coated blade

SKU #	Contents		Box/CTN
	mm	inches	
16-276	12	1/2"	6/36
16-279	18	3/4"	6/36
16-282	25	1"	6/36
16-285	12, 18, 25	1/2", 3/4", 1"	4/24

FATMAX™ COLD CHISEL WITH BI-MAT HAND GUARD



- For cutting/ shaping wrought iron, cast iron, steel, brass, bronze, copper, aluminum, bolts, nuts and rivets

SKU #	Contents	Length	Box/CTN
		inches	
16-332	FatMax™ Cold Chisel 1" x 12" with guard	1" x 12"	3/18

FATMAX™ CONCRETE CHISEL WITH BI-MAT HAND GUARD



- Durable bull point that cuts fast and lasts long
- Ideal for cutting through and breaking up concrete

SKU #	Contents	Length	Box/CTN
		inches	
16-329	Concrete Chisel 3/4" x 12" w/Guard	3/4" x 12"	3/18

COLD CHISEL



- One-piece construction forged from chrome vanadium steel for increased strength and durability
- Hardened, quenched and tempered for long life and added safety
- Powder coat finish for increased visibility
- For cutting/ shaping wrought iron, cast iron, steel, brass, bronze, copper, aluminum, bolts, nuts and rivets

SKU #	Length	Box/CTN
	inches	
STHT16289-8	3/4" x 6-7/8"	3/24
STHT16290-8	7/8" x 8"	3/24

3 PCS WOOD CHISELS SET



- Blade hardened for resharping
- Tough and shock-absorbing
- Non-rolling handle

SKU #	Description	Blade Width (in.)	Blade Width (mm)	Box Qty
STHT16089-8	3 PCS WOOD CHISEL SET	1/2", 3/4", 1"	13mm, 19mm, 25mm	5

6 PCS WOOD CHISELS SET



- Various chisel applications
- Hand carving knives in various cuts are ideal for DIY handcrafts



SKU #	Description	Product Specs	Box Qty
STHT16120-8	6 PCS WOOD CHISEL 1/4" SET	1 Sken Chisel, 1 Curved Gouge, 1 Curved Flat, 1 Curved U Tool, 1 Straight Gauge, 1 Square Chisel	12

3 PCS COLD CHISELS SET



- Multi-tool sets are ideal for starting drill holes, marking metal or cutting/splitting hard stone, brick and concrete



SKU #	Description	Blade Width (in.)	Blade Width (mm)	Box Qty
STHT16298-8	3 PCS Cold Chisel Set	3/8", 1/2", 5/8"	10mm, 12mm, 16mm	3

WOOD CHISELS



- Hardened and tempered chrome carbon-steel blade for edge retention
- Made to maximize strength and control
- Innovative ergonomic design for comfort and ease
- Working edges of the blade are protected by the blade guard
- Can be mounted to the wall for simple storage solutions

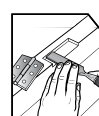
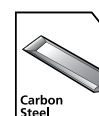

SKU #	Description	Blade Width (in.)	Blade Width (mm)	Box Qty
STHT16107-8	1/2" Wood Chisel	1/2"	13mm	12
STHT16111-8	3/4" Wood Chisel	3/4"	19mm	12
STHT16115-8	1" Wood Chisel	1"	26mm	12

CUSHION GRIP NAIL SET



- Grip is slip-resistant in all weather conditions and ribbed to absorb shock, improving precision
- 25% longer length enables user to set nails in hard to reach areas
- Fully hardened, precision-milled steel for long life
- Long, beveled tip for easy nail head alignment
- Colour coded by tip size for quick identification
- Patented design developed for professional use
- 3 pc nail set (SKU# - 58-930) contains 58-911, 58-912 and 58-913

SKU #	Colour	O / A Length		Tip		Box/CTN
		mm	inches	mm	inches	
58-911	Yellow	127	5"	0.8	1/32"	6/96

STANLEY®

FINISHING TOOLS



Files

Surform Tools & Blades





FINISH THE JOB PERFECTLY

STANLEY® is proud of its long-standing commitment to manufacturing some of the world's best finishing tools.

As you peruse this category, remember that behind every finishing tool is more than 140 years of tool-manufacturing experience, skill, and of course, Stanley's unflagging commitment to excellence.

With the wide range of **STANLEY®** finishing tools available, you can be sure that the overall quality and effect of your work will be further elevated. Whether you need something compact and lightweight with a click-on blade replacement, or something with a single-cut mill pattern for light removal, you will find what you need right here.

FILES

Depending on the type of material that the file is used on, **STANLEY®** offers a range of innovative files. File coarseness, spacing of the teeth and the tool's primary material come into play.



SURFORM®

The best known feature of the Surform® range is its compact and lightweight molded body. Surform® shavers are tough and have sidecut teeth for shaving down corners. The shaver's simple click-on blade replacement makes it easy to replace the blade, ensuring that there will be no holdups while getting the job done.



HOW TO USE SURFORM® TOOLS



For **FAST CUTTING**, use the tool at an angle of about 30° in the direction of the cut

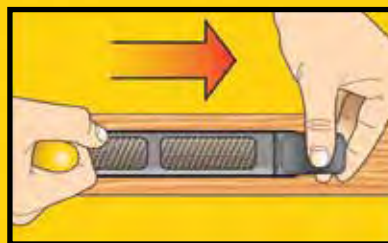

For **SMOOTHING** and **FINISHING**, use the tool parallel to the direction of the cut

ALL MASTER PAINT BRUSH



- Long bristle for durability and superior finish
- Stainless steel ferrules
- Wooden handle for comfort in use
- Superior finish with all paints

SKU #	Size		Thickness		Length-Out		Box/CTN
	mm	inches	mm	inches	mm	inches	
29-030-1	19	3/4"	9	11/32"	49	2"	12/288
29-035-1	75	3"	23	3/4"	79	3-1/8"	6/72

STICK & CAGE FRAME ROLLER

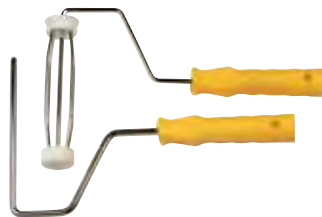

SKU #	Contents	Length		Diameter		Box/CTN
		mm	inches	mm	inches	
1-29-076	7" Stick Roller Frame	-	7"	-	-	24/48
1-29-045	9" Cage Frame	255	9"	37	1-1/2"	24/48

PAINT ROLLER - COMPLETE

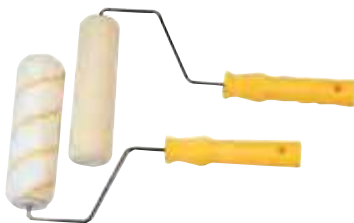

SKU #	Contents	For Use On	Length		Diameter		Box/CTN
			mm	inches	mm	inches	
1-29-069	9" Cage roller/ mogloss short refill	Gloss and eggshell paints on smooth surfaces	255	9"	37	1-1/2"	24/48
1-29-494	7" Cage roller/ acrylic med refill	Flat of masonry paint on semi smooth/rough surfaces	175	7"	37	1-1/2"	24/48

MINI ROLLER & REFILL



SKU #	Contents	For Use On	Length		Box/CTN
			mm	inches	
2-29-078	Acrylic Yellow Stripe Refill - 10/pk	Flat/ matt paint on smooth surfaces	100	4"	10/20

STICK ROLLER REFILL

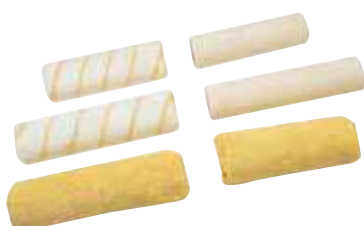

SKU #	Contents	For Use On	Length		Box/CTN
			mm	inches	
0-29-086	4" Stick Frame and refill	-	102	4"	25/100
0-29-256	7" Mogloss Short Pile	Gloss and eggshell paints on smooth surfaces	175	7"	24/48
0-29-277	9" Acrylic Yellow Stripe Med Pile	Flat/ matt paint on smooth surfaces	225	9"	24/48

TAPERED FILE



- Triangle-shape file gradually tapered in width and thickness for cutting angles less than 90°

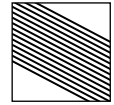
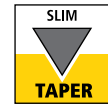

SKU #	Description	Cut	Teeth Spacing	Length (in.)	Length (mm)	Box/CTN (Dozen)
22-090 / 22-090B	4" Extra Slim Tapered	Single Cut	Second Cut	4"	100	1/6/200
22-091 / 22-091B	4" Double Extra Slim Tapered	Single Cut	Second Cut	4"	100	1/6/200
22-223 / 22-223B	8" Three Square Tapered	Double Cut	Bastard Cut	8"	200	1/9/25
22-224 / 22-224B	12" Three Square Tapered	Double Cut	Bastard Cut	12"	300	1/4/6
22-225 / 22-225B	12" Three Square Tapered	Double Cut	Second Cut	12"	300	1/4/6
22-226 / 22-226B	6" Three Square Tapered	Double Cut	Smooth Cut	6"	150	1/12/40
22-227	8" Three Square Tapered	Double Cut	Smooth Cut	8"	200	1/9
22-304 / 22-304B	4" Slim Tapered	Single Cut	Smooth Cut	4"	100	12/200
22-305 / 22-305B	5" Slim Tapered	Single Cut	Smooth Cut	5"	125	1/12/20
22-306 / 22-306B	6" Slim Tapered	Single Cut	Smooth Cut	6"	150	1/12/50

HALF ROUND FILE



- Half round file tapered in width and thickness for filing inside or rings and round holes

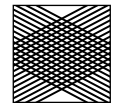

SKU #	Description	Cut	Teeth Spacing	Length (in.)	Length (mm)	Box/CTN (Dozen)
22-187 / 22-187B	8" Half Round File	Double Cut	Second Cut	8"	200	1/9/25

CHAIN SAW FILE



- For sharpening chain saws

SKU #	Description	Length		Box/CTN (Dozen)
		mm	inches	
22-082 / 22-082B	Chain Saw File	4 x 200	5/32" x 8"	1/9/75
22-083 / 22-083B	Chain Saw File	5 x 500	3/16" x 8"	1/9/15
22-087 / 22-087B	Chain Saw File	6 x 200	7/32" x 8"	1/9/15

HANDY FILE



- For sharpening agricultural tools including blades of reaping and mowing machines

SKU #	Description	Length		Box/CTN (Dozen)
		mm	inches	
22-078H	File Handy 8" C/W Handle	200	8"	1/6

FLAT FILE



- Flat file parallel in width and tapered in thickness for general material removal



SKU #	Description	Cut	Teeth Spacing	Length (in.)	Length (mm)	Box Qty
22-096 / 22-096B	10" Mill File	Single Cut	Bastard Cut	10"	250	1/8/15
22-172 / 22-172B	10" Flat File	Double Cut	Bastard Cut	10"	250	1/6/15
22-173 / 22-173B	12" Flat File	Double Cut	Bastard Cut	12"	300	1/4/6
22-233 / 22-233B	8" Flat File	Double Cut	Smooth Cut	8"	200	1/9/25
22-234 / 22-234B	10" Flat File	Double Cut	Smooth Cut	10"	250	1/6/15

SINGLE IRON



- A flat surface that is easier to sharpen
- An accurately ground edge of 25°
- Use suffix '0' for carded product
- Chrome carbon steel which has excellent edge retention characteristics and allows a razor sharp edge to be honed

SKU #	Description	Compatible To	Diameter		Box/CTN
			mm	inches	
0-12-312	Single Iron	12-003	45	1-3/4"	6/96

PROFESSIONAL™ BLOCK PLANE



- Low angle cutter seats at 13-1/2"
- For end grain and plastic laminates

SKU #	Description	Length		Cutter		Box/CTN
		mm	inches	mm	inches	
1-12-060	Professional™ Block Plane	150	6"	35	1-3/8"	1/6

PROFESSIONAL™ SMOOTHING PLANE



- Fully adjustable for depth of cut, cutter alignment and size of mouth
- Cutter seats at 21°
- For end grain and general purpose fine finishing

SKU #	Description	Length		Cutter		Box/CTN
		mm	inches	mm	inches	
1-12-020	Professional™ Smoothing Plane	160	6-1/4"	40	1-5/8"	1/6

BLOCK PLANE



- Small block plane - ideal for use by model makers

SKU #	Description	Length		Cutter		Box/CTN
		mm	inches	mm	inches	
1-12-102	Block Plane	140	5-1/2"	35	1-3/8"	1/6

PLANE



- Light weight, moulded body
- General purpose use



SKU #	Description	Length (in.)	Length (mm)	Box Qty
5-21-103	10" Surform® Plane	10"	250	6

BLOCK PLANE



- Light weight, moulded body
- For edges and confined spaces



SKU #	Description	Length (in.)	Length (mm)	Box Qty
5-21-104	5-1/2" Surform® Block Plane	5-1/2"	140	6

FLAT FILE



- Light weight, moulded body
- Slight curve on blade for increased stock removal



SKU #	Description	Length (in.)	Length (mm)	Box Qty
5-21-103	5-1/2" Surform® Flat File	5-1/2"	140	6

SHAVER TOOL



- Light weight, moulded body
- Work on pull stroke
- For universal use

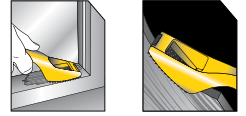

SKU #	Description	Length (in.)	Length (mm)	Box Qty
5-21-115	2-1/2 Surform® Shaver Tool	2-1/2"	64	6

SURFORM® TOOL & BLADE CHART

	21-293-5-11	21-393-5-11	21-299-5-11	21-508-5-11	21-398-5-11	21-515-5-11
Hardwood	•	•	•	•	•	•
Softwood	•	•	•	•	•	•
End Grain		•			•	
Chipboard	•		•	•		•
Plywood	•		•	•		•
Blockboard	•		•	•		•
Vinyl	•	•	•	•	•	•
Rubber	•		•	•		•
Plaster	•	•	•	•	•	•
Thermalite	•		•	•		•
Chalk	•		•	•		•
Fiberglass	•		•	•		•
Brass		•			•	
Aluminum		•			•	
Copper		•			•	
Mild Steel		•			•	
Plastic Laminates						•
Plastic Fillers	•	•	•	•	•	•
Nylon	•		•	•		•
Vinyl Flooring	•		•	•		•

CURVED BLADE

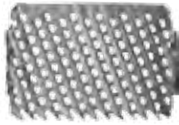

- Curved blade speeds up stock removal
- Works on the pull stroke

SKU #	Description	Fits Tool	Length (in.)	Length (mm)	Box Qty
5-21-515	2-1/2" Surform® Shaver Replacement Blade	21-115-5-11	2-1/2"	64	12

STANDARD CUT BLADE



- All purpose blade for use on wood, vinyl, plaster, thermalite, fiberglass and linoleum
- Design for working into edges, with teeth flush to the blade edge

SKU #	Description	Fits Tool	Length (in.)	Length (mm)	Box Qty
5-21-293	10" Surform® Flat Fine Cut Replacement Blade	21-103-5-11	10"	250	12

HALF ROUND BLADE

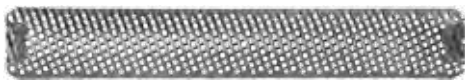

- Half-round convex blade used for fast stock removal and shaping curved surfaces
- Ideal for work on fiberglass and removing filler

SKU #	Description	Fits Tool	Length (in.)	Length (mm)	Box Qty
5-21-299	10" Surform® Half Round Replacement Blade	21-103-5-11	10"	250	12

METAL & PLASTIC BLADE



- Use on soft metal (e.g. brass, lead, aluminum, copper and mild steel), plastic, laminates, plastic fillers and fiberglass

SKU #	Description	Fits Tool	Length (in.)	Length (mm)	Box Qty
5-21-508	10" Surform® Metal & Plastic Replacement Blade	21-103-5-11	10"	250	12

FINE CUT BLADE

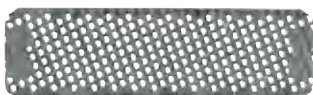

- Produces a fine finish on hardwoods, end grains and soft metals

SKU #	Description	Fits Tool	Length (in.)	Length (mm)	Box Qty
5-21-398	5-1/2" Surform® Fine Cut Replacement Blade	21-104-5-11 21-102-5-11	5-1/2"	140	12
5-21-393	10" Surform® Fine Cut Replacement Blade	21-103-5-11	10"	250	12

**TRANS
MODULE**
system

A SYSTEM TO BETTER ORGANIZE TOOLS

TransModule System features a completely integrated tool management concept

27" Roller Cabinet
7 Drawers



27" Roller Cabinet
4 Drawers



16" Tool Set
Case



19" Metal Toolbox
1 Drawer



16" Metal
Cantilever Toolbox



Standardized Tool Modules

FLEXIBLE CHOICES

Whether you are looking for a garage tool system or a service pack that is on-the-go, you can now enjoy a fully customized tool management system to suit your every need.



Storage spaces and tool modules are now one, meaning each tool module fits perfectly into any type of storage product.

STANLEY® MODULES

23 PCS
1/2" 6PTS Metric Socket
Module
STMT74173-8



36 PCS
3/8" Metric Socket Module
STMT74174-8



60 PCS
1/4" Metric Socket Module
STMT74175-8



24 PCS
1/2" Metric Bit Socket Module
STMT74176-8



10 PCS Offset Double Ring
Module
STMT74177-8



16 PCS
Combination Wrench Module
STMT74178-8



4 PCS
Pliers Set Module
STMT74179-8



4 PCS
Circle Pliers Set Module
STMT74180-8



8 PCS
Screwdrivers Module
STMT74181-8



6 PCS
Torx Screwdrivers Module
STMT74182-8



23 PCS
1/2" 12PTS Metric Socket
Module
STMT74726-8



CUSTOMIZED ACCORDING TO DEMAND

STANDARDIZED TRAY
DIMENSION THAT FITS
PERFECTLY TO VARIOUS
STORAGE OPTIONS



60 PCS 1/4" METRIC SOCKET SET



16" TOOL SET CASE + MODULE :

- 1/4" 6PTS Standard socket 4, 4.5, 5, 5.5, 6, 7, 8, 9, 10, 11, 12, 13, 14mm
- 1/4" 6PTS Deep socket 4, 5, 5.5, 6, 7, 8, 9, 10, 11, 12, 13, 14mm
- 1/4" Hexagon bit socket 2, 2.5, 3, 4, 5, 6mm
- 1/4" Bit socket slot 4, 5.5, 7mm
- 1/4" Bit socket PZ1, PZ2, PZ3
- 1/4" Bit socket PH1, PH2, PH3
- 1/4" Torx bit socket T6, T7, T8, T9, T10, T15, T20, T25
- 1/4" Torx socket E4, E5, E6, E7, E8, E10
- 1/4" Pear head ratchet NP9
- 1/4" Spinner
- 1/4" Extension 50, 100mm



SKU #	Description	L (mm)	W (mm)	H (mm)	Weight (kg)	Box Qty
STMT74175-8C	60 PCS 1/4" Metric Socket Set	405	290	60	2.26	1

23 PCS 1/2" 6PTS METRIC SOCKET SET



16" TOOL SET CASE + MODULE :

- 1/2" Pear head ratchet NP9
- 1/2" L-handle 90 degree
- 1/2" Extension 125, 250mm
- 1/2" Universal joint
- 1/2" 6PTS Standard socket 8, 9, 10, 11, 12, 13, 14, 15, 16, 17, 18, 19, 21, 22, 24, 27, 30, 32mm



SKU #	Description	L (mm)	W (mm)	H (mm)	Weight (kg)	Box Qty
STMT74173-8C	23 PCS 1/2" 6 PTS Metric Socket Set	405	290	60	3.95	1

23 PCS 1/2" 12PTS METRIC SOCKET SET



16" TOOL SET CASE + MODULE :

- 1/2" Pear head ratchet NP9
- 1/2" L-handle 90 degree
- 1/2" Extension 125, 250mm
- 1/2" Universal joint
- 1/2" 12PTS Standard socket 8, 9, 10, 11, 12, 13, 14, 15, 16, 17, 18, 19, 21, 22, 24, 27, 30, 32mm



SKU #	Description	L (mm)	W (mm)	H (mm)	Weight (kg)	Box Qty
STMT74726-8C	23 PCS 1/2" 12 PTS Metric Socket Set	405	290	60	3.95	1

16" TOOL SET CASE



ONE HAND OPERATION

Single sliding latch drives efficient work flow

COMPATIBLE with
**TRANS
MODULE**
system

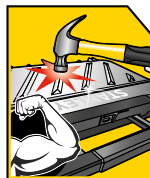

TOUGH LID

Extra tough transparent cover design provides clear visibility & protection

REMOVABLE DIVIDER

For additional organization



BIG HANDLE

Easy-to-carry handle

Label slot for unit identification

SKU #	Description	Length (mm)	Width (mm)	Height (mm)	Weight (kg)	Latch
STST74301-8	16" Tool Set Case	405	290	60	0.7	Plastic

STANLEY®

WRENCHES



Wrench Sets

Wrenches

T-Handle



WRENCHES



A PROFESSIONAL CHOICE FOR EVERY TASK

Flexibility is the key to an efficient working environment and the **STANLEY® AUTOMOTIVE** range of wrenches have been carefully selected to offer a professional choice to match the job in hand.

Fully certified to ISO and ANSI standards, you can be sure of outstanding performance in any situation.

INNOVATIVE DESIGN FOR ENHANCED PERFORMANCE

Monitoring tool performance in real working situations, our designers have created uniquely profiled jaws and rings make the range comfortable to use, minimising downtime and keeping jobs on schedule.

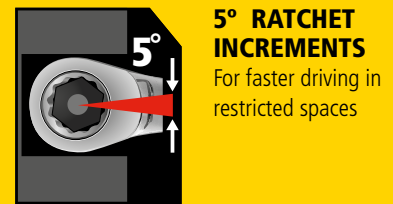
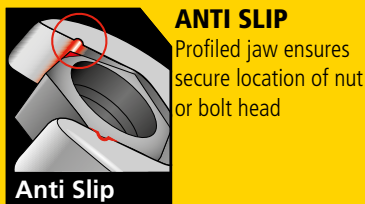

WRENCH RANGE OVERVIEW

WRENCH POUCH SET



COMBINATION WRENCHES

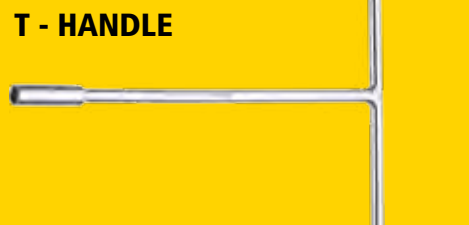

COMBINATION WRENCHES

SLIMLINE 9 PIECE COMBINATION WRENCH SET

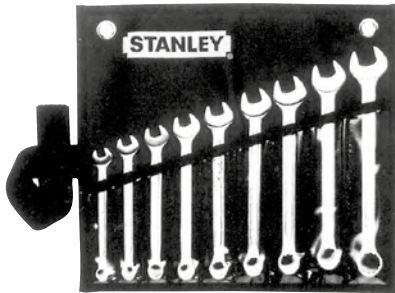

- Made of Chrome Vanadium Steel
- Both the open ended head and the ring are angled at 15° for optimum accessibility
- Nickel chrome plating protects against corrosion
- Slim pattern
- MaxiDrive™ and anti-slip open ended jaw shape maintains grip on fastener with only slight rotational pressure
- Anti-slip feature

SKU #	Contents	Weight (g)	Box/CTN
87-034-1	"Slimline" wrench: 8, 9, 10, 11, 12, 13, 14, 15, 17mm Heavy-duty nylon pouch Inner box	910	20/20
87-033-1	"Slimline" wrench: 10, 11, 12, 13, 14, 15, 16, 17, 19mm Heavy-duty nylon pouch Inner box	1490	16/16

SLIMLINE 14 PIECE COMBINATION WRENCH SET



- Made of Chrome Vanadium Steel
- Both the open ended head and the ring are angled at 15° for optimum accessibility
- Nickel chrome plating protects against corrosion
- Slim pattern
- MaxiDrive™ and anti-slip open ended jaw shape maintains grip on fastener with only slight rotational pressure
- Anti-slip feature

SKU #	Contents	Weight (g)	Box/CTN
87-036-1	"Slimline" wrench: 8, 9, 10, 11, 12, 13, 14, 15, 16, 17, 19, 21, 22, 24mm Heavy-duty nylon pouch Inner box	3600	10/10
87-038-1	"Slimline" wrench: 10, 11, 12, 13, 14, 17, 19, 21, 22, 23, 24, 26, 30, 32mm Heavy-duty nylon pouch Inner box	2300	1/6
87-709-1	"Slimline" wrench: 3/8", 7/16", 1/2", 9/16", 5/8", 11/16", 3/4", 13/16", 7/8", 15/16", 1", 1 1/16", 1 1/8", 1 1/4" Heavy-duty nylon pouch Inner box	10400	1/6

DOUBLE OPEN END WRENCH SET



- Made of Chrome Vanadium Steel
- Ends are slanted 15° for quick operation
- Two sizes per wrench
- Comprehensive set of open end wrench for the most common sizes
- Anti-slip feature

SKU #	Contents	Weight (g)	Box/CTN
87-718-1 8 pc	"Slimline" wrench: (Metric) 6 x 7, 8 x 9, 10 x 11, 12 x 13, 14 x 15, 16 x 17, 18 x 19, 20 x 22mm Heavy-duty nylon pouch Inner box	590	1/12

SLIMLINE 8 PIECE COMBINATION WRENCH SET



- Made of Chrome Vanadium Steel
- Both the open ended head and the ring are angled at 15° for optimum accessibility
- Nickel chrome plating protects against corrosion
- Slim pattern
- MaxiDrive™ and anti-slip open ended jaw shape maintains grip on fastener with only slight rotational pressure
- Anti-slip feature

SKU #	Contents	Weight (g)	Box/CTN
87-011-1	"Slimline" wrench: 8, 10, 11, 13, 14, 17, 19, 22mm Heavy-duty nylon pouch Inner box	920	20/20

75° OFFSET RING END WRENCH SET



- Double ring wrench chrome vanadium steel
- MaxiDrive™ Plus profile - Attacks on the sides, not the corners of the nut or bolt
- Twelve-edged head for optimal support of hexagonal and square nuts
- Polished and chrome-plated finish for excellent protection
- Heads to 70 ° for greater access in tight spaces
- Powerful and safe working
- Anti-slip feature

SKU #	Contents	Weight (g)	Box/CTN
87-617-3	"Slimline" wrench: (Metric) 6 x 7, 8 x 9, 10 x 11, 12 x 13, 14 x 15, 16 x 17, 18 x 19, 20 x 22, 21 x 23, 24 x 27mm Inner box	2200	10/10

COMBINATION WRENCHES

23 PCS COMBINATION WRENCH SET



- Combination wrench 6mm
- Combination wrench 7mm
- Combination wrench 8mm
- Combination wrench 9mm
- Combination wrench 10mm
- Combination wrench 11mm
- Combination wrench 12mm
- Combination wrench 13mm
- Combination wrench 14mm
- Combination wrench 15mm
- Combination wrench 16mm
- Combination wrench 17mm
- Combination wrench 18mm
- Combination wrench 19mm
- Combination wrench 20mm
- Combination wrench 21mm
- Combination wrench 22mm
- Combination wrench 23mm
- Combination wrench 24mm
- Combination wrench 25mm
- Combination wrench 27mm
- Combination wrench 30mm
- Combination wrench 32mm



SKU #	Description	Qty (mm)	L (mm)	W (mm)	Weight (kg)	Box Qty
STMT33650-8	23 PCS Combination Wrench Set	23	491	115	6.1	1

14 PCS COMBINATION WRENCH SET



- Combination wrench 8 mm
- Combination wrench 9 mm
- Combination wrench 10 mm
- Combination wrench 11 mm
- Combination wrench 12 mm
- Combination wrench 13 mm
- Combination wrench 14 mm
- Combination wrench 15 mm
- Combination wrench 16 mm
- Combination wrench 17 mm
- Combination wrench 18 mm
- Combination wrench 19 mm
- Combination wrench 22 mm
- Combination wrench 24 mm



SKU #	Description	Qty (mm)	L (mm)	W (mm)	Weight (kg)	Box Qty
STMT33647-8	14 PCS Combination Wrench Set	14	388	87	2.3	1

WRENCHES

8 PCS COMBINATION WRENCH SET



- Combination wrench 8 mm
- Combination wrench 10 mm
- Combination wrench 11 mm
- Combination wrench 12 mm
- Combination wrench 13 mm
- Combination wrench 14 mm
- Combination wrench 17 mm
- Combination wrench 19 mm



SKU #	Description	Qty (mm)	L (mm)	W (mm)	Weight (kg)	Box Qty
STMT73649-8	8 PCS Combination Wrench Set	8	324	67	0.93	1

6 PCS COMBINATION WRENCH SET



- Combination wrench 10 mm
- Combination wrench 12 mm
- Combination wrench 14 mm
- Combination wrench 17 mm
- Combination wrench 19 mm
- Combination wrench 21 mm



SKU #	Description	Qty (mm)	L (mm)	W (mm)	Weight (kg)	Box Qty
STMT73648-8	6 PCS Combination Wrench Set	6	351	67	1.04	1

6 PCS DOUBLE OPEN END WRENCH SET



- Open-end wrench 6x7 mm
- Open-end wrench 8x10 mm
- Open-end wrench 11x13mm
- Open-end wrench 12x14 mm
- Open-end wrench 17x19 mm
- Open-end wrench 21x23 mm



SKU #	Description	Qty (mm)	L (mm)	W (mm)	Weight (kg)	Box Qty
STMT73663-8	6 PCS Double Open End Wrench Set	6	321	67	0.96	1

6 PCS DOUBLE RING WRENCH SET



- Offset double ring wrench 8x10 mm
- Offset double ring wrench 11x13 mm
- Offset double ring wrench 12x14 mm
- Offset double ring wrench 17x19 mm
- Offset double ring wrench 21x23 mm
- Offset double ring wrench 22x24 mm



SKU #	Description	Qty (mm)	L (mm)	W (mm)	Weight (kg)	Box Qty
STMT73664-8	6 PCS Double Ring Wrench Set	6	406	67	1.41	1

10 PCS OFFSET DOUBLE RING MODULE



COMPATIBLE with
**TRANS
MODULE**
system

- Offset double ring wrench 6x7mm
- Offset double ring wrench 8x9mm
- Offset double ring wrench 10x12mm
- Offset double ring wrench 11x13mm
- Offset double ring wrench 12x14mm
- Offset double ring wrench 14x15mm
- Offset double ring wrench 16x17mm
- Offset double ring wrench 18x19mm
- Offset double ring wrench 21x23mm
- Offset double ring wrench 22x24mm



SKU #	Description	Length (mm)	Width (mm)	Height (mm)	Carton Qty
STMT74177-8	10 PCS Offset Double Ring Module	384	184	45	4

16 PCS COMBINATION WRENCH MODULE (CWF)



COMPATIBLE with
**TRANS
MODULE**
system

- Combination wrench 6mm
- Combination wrench 7mm
- Combination wrench 8mm
- Combination wrench 9mm
- Combination wrench 10mm
- Combination wrench 11mm
- Combination wrench 12mm
- Combination wrench 13mm
- Combination wrench 14mm
- Combination wrench 15mm
- Combination wrench 16mm
- Combination wrench 17mm
- Combination wrench 18mm
- Combination wrench 19mm
- Combination wrench 22mm
- Combination wrench 24mm



SKU #	Description	Length (mm)	Width (mm)	Height (mm)	Carton Qty
STMT74178-8	16 PCS Combination Wrench Module (CWF)	384	184	45	4

COMBINATION WRENCH (CWF)

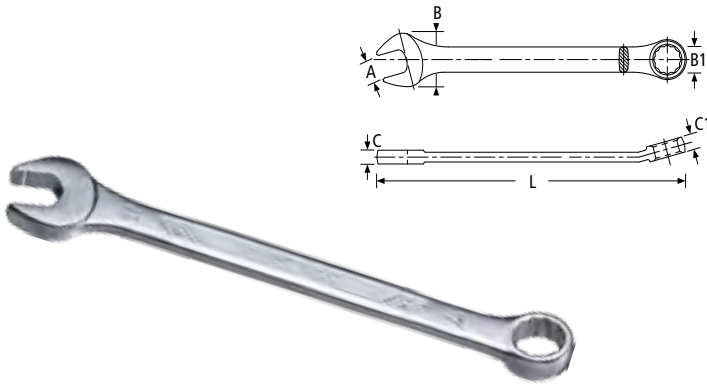

- ASME B107.17M, ASME B107.100, ASME B107.6
- Maxi-Drive™ system helps reduce fastener rounding
- Anti-slip design on open-end
- large design
- Matt finishing
- Chrome vanadium steel
- 12-point ring angled at 15°



Retail SKU #	Bulk SKU #	Description	A (mm)	L (mm)	B (mm)	B1 (mm)	C (mm)	Cl (mm)	Weight (kg)	Box Qty
STMT72803-8	STMT72803-8B	Combination Wrench 6 mm	6	101	15.6	11.5	4.5	6.2	0.022	10
STMT72804-8	STMT72804-8B	Combination Wrench 7 mm	7	108	17.3	11.5	4.7	6.6	0.026	10
STMT72805-8	STMT72805-8B	Combination Wrench 8 mm	8	111	19.6	13.9	4.9	6.7	0.031	10
STMT72806-8	STMT72806-8B	Combination Wrench 9 mm	9	123	20.8	16.2	5.1	7.1	0.039	10
STMT72807-8	STMT72807-8B	Combination Wrench 10 mm	10	131	22	16.2	5.5	7.4	0.045	10
STMT72808-8	STMT72808-8B	Combination Wrench 11 mm	11	147	24.2	17.9	6.3	7.9	0.064	10
STMT72809-8	STMT72809-8B	Combination Wrench 12 mm	12	155	25.7	19	6.5	8.3	0.074	10
STMT72810-8	STMT72810-8B	Combination Wrench 13 mm	13	164	27.2	20.3	7.1	8.7	0.087	10
STMT72811-8	STMT72811-8B	Combination Wrench 14 mm	14	182	30.8	22.3	7.7	9.2	0.124	10
STMT72812-8	STMT72812-8B	Combination Wrench 15 mm	15	192	32.4	23.5	8.0	9.7	0.140	10
STMT72813-8	STMT72813-8B	Combination Wrench 16 mm	16	202	34	24.7	8.2	10.3	0.159	10
STMT72814-8	STMT72814-8B	Combination Wrench 17 mm	17	223	37.8	26.9	8.6	10.7	0.193	10
STMT72815-8	STMT72815-8B	Combination Wrench 18 mm	18	234	39.3	28.2	8.8	11.3	0.222	10
STMT72816-8	STMT72816-8B	Combination Wrench 19 mm	19	246	40.8	29.2	9.0	11.8	0.238	10
STMT72817-8	STMT72817-8B	Combination Wrench 20 mm	20	258	42.2	30.5	9.2	12.2	0.263	10
STMT72818-8	STMT72818-8B	Combination Wrench 21 mm	21	271	43.6	31.8	9.5	12.6	0.294	10
STMT72819-8	STMT72819-8B	Combination Wrench 22 mm	22	296	46	33.8	10.0	13.1	0.361	5
STMT72820-8	STMT72820-8B	Combination Wrench 23 mm	23	308	47.5	34.9	10.4	13.5	0.385	5
STMT72821-8	STMT72821-8B	Combination Wrench 24 mm	24	321	49	36	10.8	13.9	0.435	5
-	STMT72822-8B	Combination Wrench 25 mm	27	343	52	38.1	11.5	14.6	0.516	5
-	STMT72823-8B	Combination Wrench 26 mm	30	343	52	38.1	11.5	14.6	0.506	5
-	STMT72824-8B	Combination Wrench 27 mm	32	375	56	40.5	12.5	15.7	0.516	5
-	STMT72825-8B	Combination Wrench 28 mm	28	395	58	42.8	13.2	16.7	0.723	5
-	STMT72826-8B	Combination Wrench 29 mm	29	395	58	42.8	13.2	16.7	0.72	5
-	STMT72827-8B	Combination Wrench 30 mm	30	395	58	42.8	13.2	16.7	0.703	5
-	STMT72828-8B	Combination Wrench 32 mm	32	429	65.7	47.4	14.0	18.7	0.963	5



“ THE PATENTED ANTI-SLIP FEATURE ON THE COMBINATION WRENCH HAS DEFINITELY SAVED MY KNUCKLES MORE TIMES THAN I CAN COUNT. THOSE IN OUR INDUSTRY KNOW HOW IMPORTANT THIS INJURY-PROOF CHARACTERISTIC IS. ”

SLIMLINE COMBINATION WRENCH

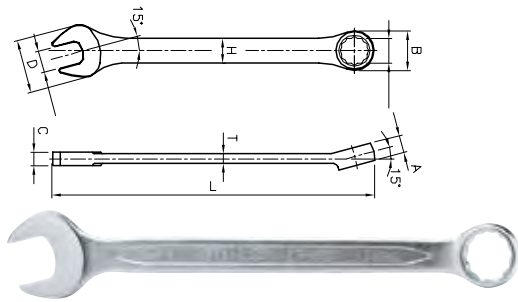

- Made of Chrome Vanadium Steel
- Both the open ended head and the ring are angled at 15° for optimum accessibility
- Nickel chrome plating protects against corrosion
- Slim pattern
- MaxiDrive™ and anti-slip open ended jaw shape maintains grip on fastener with only slight rotational pressure
- Anti-slip feature

SKU #	Size	L mm	A mm	B mm	C mm	D mm	H mm	T mm	Box/CTN
87-660-1	1/4"	100.0	4.7	10.1	4.0	15.5	7.1	2.7	6/72
87-661-1	5/16"	120.0	5.5	12.8	4.5	19.2	8.4	3.0	6/90
87-662-1	3/8"	140.0	6.5	15.6	5.0	23.2	9.6	3.5	6/72
87-663-1	7/16"	150.0	6.9	16.9	5.4	25.3	10.4	3.7	6/90
87-664-1	1/2"	170.0	7.8	19.7	5.9	29.4	12.1	4.1	6/90
87-665-1	9/16"	180.0	8.3	21.2	6.2	31.5	12.9	4.4	6/54
87-666-1	5/8"	200.0	8.9	24.0	6.7	34.7	13.9	4.8	6/54
87-667-1	11/16"	210.0	9.3	25.3	6.9	36.5	14.6	5.0	6/54
87-668-1	3/4"	230.0	10.5	28.1	7.4	40.7	15.9	5.4	6/60
87-669-1	13/16"	250.0	11.3	31.3	8.0	44.8	17.3	5.7	4/24
87-670-1	7/8"	260.0	11.5	32.6	8.2	46.9	18.0	5.8	4/24
87-671-1	15/16"	280.0	12.1	35.5	8.7	50.4	19.5	6.0	4/24
87-672-1	1"	290.0	12.5	36.9	8.9	52.0	20.1	6.2	4/24
87-673-1	1-1/16"	310.0	13.1	39.6	9.4	55.7	21.8	6.6	4/24
87-674-1	1-1/8"	330.0	13.3	40.9	9.7	57.6	22.5	6.8	2/12
87-675-1	1-1/4"	360.0	14.3	46.4	10.4	65.8	24.8	7.3	2/12

SKU #	Size	L mm	A mm	B mm	C mm	D mm	H mm	T mm	Box /CTN
87-424-1	5	95.0	4.1	8.9	3.5	13.6	6.2	2.4	6/72
87-429-1	5.5	95.0	4.1	8.9	3.5	13.6	6.2	2.4	6/72
87-066	6	100.0	4.7	10.1	4.0	15.5	7.1	2.7	6/72
87-057	7	110.0	5.0	11.5	4.0	17.0	7.8	2.8	6/90
87-058	8	120.0	5.5	12.8	4.5	19.2	8.4	3.0	6/90
87-069	9	130.0	5.9	14.2	4.5	21.2	9.0	3.3	6/72
87-070	10	140.0	6.5	15.6	5.0	23.2	9.6	3.5	6/72
87-071	11	150.0	6.9	16.9	5.4	25.3	10.4	3.7	6/72
87-072	12	160.0	7.3	18.3	5.5	27.2	11.3	3.9	6/72
87-073	13	170.0	7.8	19.7	5.9	29.4	12.1	4.1	6/54
87-074	14	180.0	8.3	21.2	6.2	31.5	12.9	4.4	6/54
87-075	15	190.0	8.6	22.5	6.4	33.2	13.5	4.6	6/54
87-076	16	200.0	8.9	24.0	6.7	34.7	13.9	4.8	6/54
87-077	17	210.0	9.3	25.3	6.9	36.5	14.6	5.0	6/54
87-078	18	220.0	9.9	26.8	7.2	38.7	15.3	5.2	6/54
87-079	19	230.0	10.5	28.1	7.4	40.7	15.9	5.4	6/60
87-080	20	240.0	10.9	29.7	7.7	43.1	16.8	5.6	4/24
87-081	21	250.0	11.3	31.3	8.0	44.8	17.3	5.7	4/24
87-082	22	260.0	11.5	32.6	8.2	46.9	18.0	5.8	4/24
87-083	23	270.0	11.8	34.2	8.4	48.3	18.7	5.9	4/24
87-084	24	280.0	12.1	35.5	8.7	50.4	19.5	6.0	4/24
87-085-1	25	290.0	12.5	36.9	8.9	52.0	20.1	6.2	4/24
87-086-1	26	300.0	12.8	38.2	9.2	53.6	21.0	6.4	4/24
87-087	27	310.0	13.1	39.6	9.4	55.7	21.8	6.6	4/24
87-088-1	28	320.0	13.3	40.9	9.7	57.6	22.5	6.8	2/12
87-089-1	29	330.0	13.5	42.3	9.9	59.7	23.3	7.0	2/12
87-090	30	340.0	13.7	43.7	10.1	61.8	23.9	7.1	2/12
87-092	32	360.0	14.3	46.4	10.4	65.8	24.8	7.3	2/12
87-263	33	408.0	14.5	11.0	48.0	62	23.0	11.0	1/30
87-264	34	408.0	14.5	11.0	48.0	62	23.0	11.0	1/25
87-265	35	430.0	17.0	15.0	56.5	70	26.0	12.0	1/25
87-266	36	430.0	17.0	15.0	56.5	70	26.0	12.0	1/25
87-268	38	460.0	17.0	15.0	56.5	70	26.0	12.0	1/20
87-271	41	490.0	19.0	16.5	65.0	83	29.0	14.0	1/15
87-272	42	490.0	19.0	16.5	65.0	83	29.0	14.0	1/15
87-276	46	540.0	19.0	16.5	65.0	83	29.0	14.0	1/15
87-278	48	563.0	24.0	19.0	72.5	94	35.0	15.0	1/10
87-280	50	587.0	24.0	19.0	72.5	94	35.0	15.0	1/10

OPEN END WRENCH

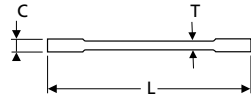
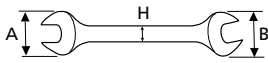

- Made of Chrome Vanadium Steel
- Ends are slanted 15° for quick operation
- Two sizes per wrench
- Anti-slip feature

SKU #	Size	L mm	A mm	B mm	C mm	H mm	T mm	Weight (g)	Box/CTN
87-096-1	6x7	122.0	16.2	18.1	3.3	8.6	2.2	25	6/90
87-097-1	8x9	140.0	20.2	22.2	3.6	10.7	2.5	35	6/120
84-758	8x10	140.0	20.2	22.2	3.6	10.7	2.5	43	20/500
87-098-1	10x11	156.0	23.6	25.6	4.6	11.7	3.0	50	20/200
84-759	10x12	156.0	23.6	25.6	4.6	11.7	3.0	63	20/200
87-099-1	12x13	172.0	27.4	28.6	5.1	12.7	3.4	75	20/200
84-760	12x14	180.0	28.6	31.6	5.1	13.7	3.8	90	20/200
87-100-1	14x15	188.0	31.5	34.0	5.6	14.2	3.8	105	20/200
84-764	14x17	188.0	31.5	34.0	5.6	14.2	3.8	130	20/200
87-101-1	16x17	204.0	36.1	38.4	6.1	15.8	4.3	155	20/100
84-765	17x19	220.0	38.6	42.1	6.5	16.8	4.7	173	12/120
87-102-1	18x19	220.0	38.6	42.1	6.5	16.8	4.7	190	12/120
84-766	19x21	234.0	42.0	46.1	7.2	18.3	4.8	205	12/60
87-103-1	20x22	234.0	42.0	46.1	7.2	18.3	4.8	220	12/60
87-104-1	21x23	247.0	45.4	48.6	7.5	19.3	4.8	245	12/60
84-767	22x24	247.0	45.4	48.6	7.5	19.3	4.8	275	12/60
87-105-1	24x27	266.0	50.8	56.3	8.2	20.8	5.4	305	4/32
87-106-1	25x28	285.0	53.8	62.3	8.4	22.4	5.6	340	2/36
87-107-1	30x32	302.0	60.3	65.3	9.1	24.4	6.1	465	2/32

SKU #	Size	L mm	A mm	B mm	C mm	H mm	T mm	Weight (g)	Box/CTN
87-676-1	1/4"x5/16"	123.0	15.5	18.0	3.7	8.0	2.9	25	6/72
87-677-1	5/16"x3/8"	140.0	20.4	22.7	4.0	10.2	3.1	35	6/120
87-678-1	3/8"x7/16"	156.0	24.9	27.1	5.0	11.7	3.4	50	6/72
87-679-1	7/16"x1/2"	172.0	29.2	31.2	5.5	13.1	3.8	75	6/90
87-705-1	1/2"x9/16"	180.0	31.3	33.3	5.5	14.0	4.0	85	6/90
87-680-1	9/16"x5/8"	188.5	33.3	35.3	5.9	14.8	4.1	105	6/48
87-681-1	5/8"x11/16"	204.0	37.1	38.9	6.3	15.6	4.4	155	6/54
87-682-1	11/16"x3/4"	221.0	40.9	42.8	6.7	16.6	4.6	190	6/24
87-683-1	13/16"x7/8"	237.0	44.8	48.8	7.1	18.5	4.9	220	6/48
87-706-1	15/16"x1"	255.0	50.8	56.8	7.9	21.4	5.3	270	4/32
87-684-1	15/16"x1-1/16"	263.0	52.8	59.1	8.1	22.1	5.4	305	4/24
87-685-1	1"x1-1/8"	279.0	54.8	61.3	8.5	23.0	5.7	340	2/12
87-686-1	1-1/8"x1-1/4"	298.0	65.4	69.8	9.0	24.6	6.0	465	2/12

OPEN END WRENCH

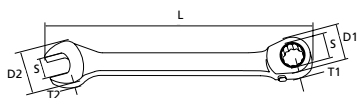
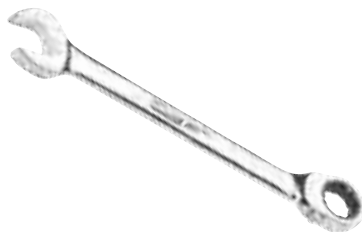

- Chrome-vanadium special heat-treat provides a strong thin wall
- 72-teeth ratcheting system provides high torque and 5° of operation in tight areas
- An unique 15° offset design enables access to countersink bolts
- Worldwide patent

SKU #	Size	D1 mm	D2 mm	T1 mm	T2 mm	L mm	Box/CTN
79-064-S	8	18.0	17.0	7.4	4.7	144	10/100
79-065-S	9	19.5	18.8	7.4	5.3	150	10/100
79-066-S	10	21.0	21.7	8.4	5.7	158	10/100
79-067	11	22.0	23.0	8.4	6.1	165	10/100
79-068-S	12	23.5	25.2	8.4	6.4	173	10/100
79-069-S	13	25.0	26.5	8.4	6.6	182	10/100
79-070-S	14	26.5	29.5	8.4	7.3	190	10/100
79-071	15	28.0	31.3	8.4	7.5	202	10/100
79-072	16	29.0	33.4	10.0	7.7	215	10/100
79-073	17	30.5	36.3	10.0	7.9	229	10/100
79-074	18	32.0	38.0	11.5	8.4	240	10/100
79-075	19	34.0	39.0	11.5	8.7	252	10/100

DOUBLE OPEN-END WRENCH

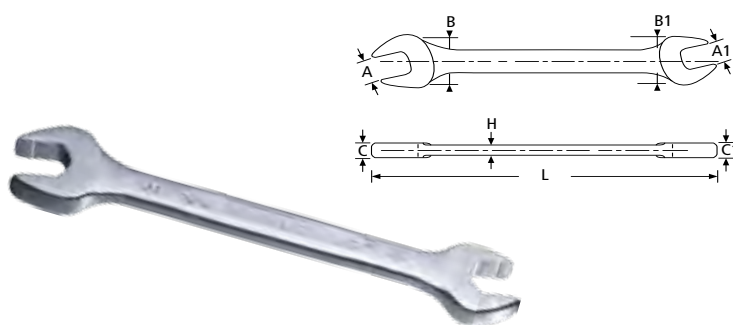

- ASME B107.17M, ASME B107.100, ASME B107.39
- Anti-slip design on open-end
- Matt finishing
- Chrome Vanadium steel



Retail SKU #	Bulk SKU #	Description	A (mm)	A1 (mm)	L (mm)	B (mm)	B1 (mm)	C (mm)	C1 (mm)	Weight (kg)	Box Qty
STMT72837-8	STMT72837-8B	Open-End Wrench 6X7 mm	6	7	108.2	14.4	17.3	5.0	5.3	0.024	10
STMT72838-8	STMT72838-8B	Open-End Wrench 7X9 mm	7	9	128.2	17.7	19.8	5.4	5.7	0.035	10
STMT72839-8	STMT72839-8B	Open-End Wrench 8X10 mm	8	10	128.8	17.7	19.8	5.4	5.7	0.035	10
STMT72840-8	STMT72840-8B	Open-End Wrench 10X12 mm	10	12	133.0	21.1	24.4	5.9	6.2	0.051	10
STMT72841-8	STMT72841-8B	Open-End Wrench 10X11 mm	10	11	133.0	21.1	24.4	5.9	6.2	0.051	10
STMT72842-8	STMT72842-8B	Open-End Wrench 11X13mm	11	13	146.2	24.8	27.8	6.6	6.9	0.075	10
STMT72843-8	STMT72843-8B	Open-End Wrench 12X14 mm	12	14	156.8	27.8	31.1	7.8	8.2	0.110	10
STMT72844-8	STMT72844-8B	Open-End Wrench 12X13 mm	12	13	146.2	24.8	27.8	6.6	6.9	0.075	10
STMT72845-8	STMT72845-8B	Open-End Wrench 14X15 mm	14	15	179.0	31.1	34.4	7.8	8.2	0.133	10
STMT72846-8	STMT72846-8B	Open-End Wrench 14X17mm	14	17	179.0	31.1	34.4	7.8	8.2	0.133	10
STMT72847-8	STMT72847-8B	Open-End Wrench 16X17mm	16	17	198.1	34.4	37.8	8.3	8.7	0.176	10
STMT72848-8	STMT72848-8B	Open-End Wrench 18X19mm	18	19	221.9	37.8	41.1	8.6	9.0	0.218	10
STMT72849-8	STMT72849-8B	Open-End Wrench 17X19 mm	17	19	221.9	37.8	41.1	8.6	9.0	0.219	10
STMT72850-8	STMT72850-8B	Open-End Wrench 19X21mm	19	21	237.7	41.1	47.8	10.0	10.4	0.317	10
STMT72851-8	STMT72851-8B	Open-End Wrench 20X22 mm	20	22	237.7	41.1	47.8	10.0	10.4	0.315	10
STMT72852-8	STMT72852-8B	Open-End Wrench 21X23 mm	21	23	253.2	44.4	47.8	10.5	10.9	0.353	10
STMT72853-8	STMT72853-8B	Open-End Wrench 22X24 mm	22	24	253.2	44.4	47.8	10.5	10.9	0.351	10
-	STMT72854-8B	Open-End Wrench 24X26 mm	24	26	271.9	51.1	52.8	10.9	11.3	0.452	5
-	STMT72856-8B	Open-End Wrench 27X32mm	27	32	340.0	56.0	67.0	12.6	13.0	0.745	5

OFFSET COMBINATION WRENCH

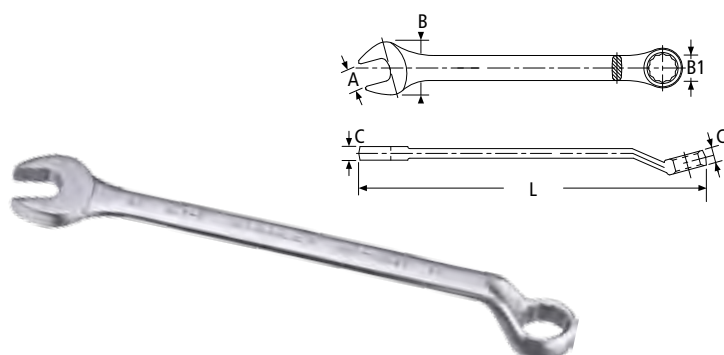

- DIN 3133 B, DIN 17350, ISO 1711
- Chrome vanadium steel
- Matt finishing
- 70° Off-set



SKU #	Description	A (mm)	L (mm)	B (mm)	B' (mm)	C (mm)	C' (mm)	Weight (kg)	Box Qty
86-0430	Offset Combination Wrench 30mm	30	382.5	61.5	42	9.9	14.4	0.630	2
86-0432	Offset Combination Wrench 32mm	32	404	66	44.5	10.1	15.2	0.779	2
86-0436	Offset Combination Wrench 36mm	36	449	76	53.1	13.1	21.8	1.390	2

OFFSET DOUBLE RING WRENCH

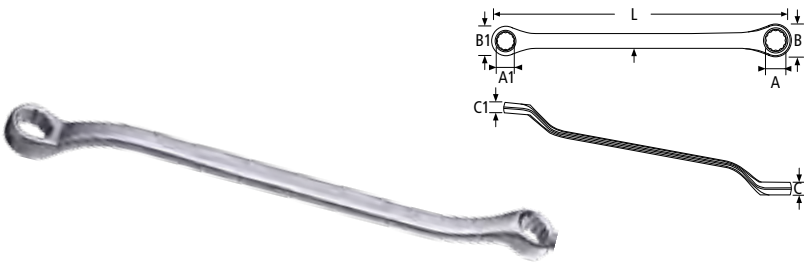

- ASME B107.17M, ASME B107.100, ASME, B107.9
- Maxi-Drive™ system helps reduce fastener rounding
- Matt finishing
- Chrome vanadium steel
- 45° Off-set



Retail SKU #	Bulk SKU #	Description	Size (mm)	L (mm)	A (mm)	AI (mm)	B (mm)	BI (mm)	C (mm)	CI (mm)	Weight (kg)	Box Qty
STMT72857-8	STMT72857-8B	Offset Double Ring Wrench - 6x7	6x7	161.8	6.1	8	11	11.8	6.2	6.2	0.04	10
STMT72858-8	STMT72858-8B	Offset Double Ring Wrench - 8x9	8x9	178.8	8	9.5	13.6	14.4	6.7	6.7	0.05	10
STMT72859-8	STMT72859-8B	Offset Double Ring Wrench - 8x10	8x10	178.8	8	9.5	13.6	14.4	6.7	6.7	0.05	10
STMT72860-8	STMT72860-8B	Offset Double Ring Wrench - 10x12	10x12	195.8	9.5	11	15.5	17.9	7.2	7.2	0.07	10
STMT72861-8	STMT72861-8B	Offset Double Ring Wrench - 11x13	11x13	214.8	11	12.6	17.9	20.3	8.3	8.3	0.10	10
STMT72862-8	STMT72862-8B	Offset Double Ring Wrench - 12x14	12x14	230.8	12.6	14	20.3	23.2	9.5	9.5	0.12	10
STMT72863-8	STMT72863-8B	Offset Double Ring Wrench - 14x15	14x15	246.8	14	15.8	23.2	24.8	10.3	10.3	0.17	10
STMT72864-8	STMT72864-8B	Offset Double Ring Wrench - 14x17	14x17	246.8	14	15.8	23.2	24.8	10.3	10.3	0.15	10
STMT72865-8	STMT72865-8B	Offset Double Ring Wrench - 16x17	16x17	255.8	15.8	17.2	24.6	26.1	10.8	10.8	0.18	10
STMT72867-8	STMT72867-8B	Offset Double Ring Wrench - 18x19	18x19	295.8	17.2	19	26.1	28.5	12.2	12.2	0.26	5
STMT72868-8	STMT72868-8B	Offset Double Ring Wrench - 19x21	19x21	310.8	19	22.1	28.5	33.4	17	17	0.33	5
STMT73575-8	STMT73575-8B	Offset Double Ring Wrench - 21x23	21x23	320.8	20.7	22.1	30.7	33.4	18	18	0.39	5
STMT72869-8	STMT72869-8B	Offset Double Ring Wrench - 22x24	22x24	320.8	20.7	22.1	30.7	33.4	18	18	0.38	5
-	STMT72870-8B	Offset Double Ring Wrench - 24x27	24x27	350.8	23.7	25.4	35.1	36.8	20	20	0.48	5

RATCHETING WRENCH

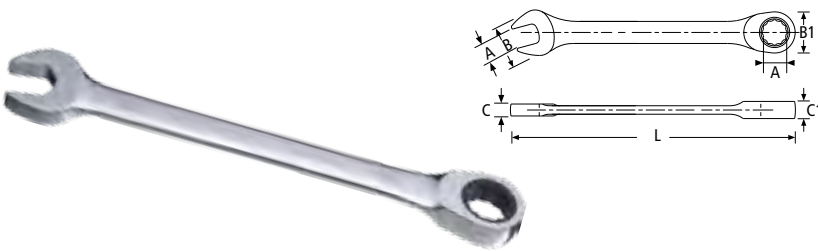

- ISO 1711-1, ISO 691, DIN 3113
- Maxi-Drive™ system helps reduce fastener rounding
- 5° increment
- Chrome vanadium steel
- Full polished finishing



SKU #	Description	Jaw (mm)	L (mm)	B (mm)	BI (mm)	C (mm)	CI (mm)	Weight (kg)	Box Qty
STMT89934-8B	Ratcheting Wrench 8 mm	8	111.6	19.4	16.8	19.4	7	0.028	10
STMT89935-8B	Ratcheting Wrench 9 mm	9	123.6	20.7	19	20.6	7.3	0.04	10
STMT89936-8B	Ratcheting Wrench 10 mm	10	131.2	21.9	20	21.7	7.8	0.048	10
STMT80012-8B	Ratcheting Wrench 11 mm	11	148.2	24.2	20.8	24.3	8.2	0.062	10
STMT89937-8B	Ratcheting Wrench 12 mm	12	155.2	25.7	23	25.4	8.7	0.08	10
STMT89938-8B	Ratcheting Wrench 13 mm	13	162.5	27.2	25	27.2	9	0.086	10
STMT89939-8B	Ratcheting Wrench 14 mm	14	182.4	30.8	27	30.7	9.5	0.12	10
STMT89940-8B	Ratcheting Wrench 15 mm	15	192.2	32.2	28	32.1	9.9	0.134	10
STMT89941-8B	Ratcheting Wrench 16 mm	16	202.2	34	30	33.8	10.4	0.15	10
STMT89942-8B	Ratcheting Wrench 17 mm	17	222.5	37.7	31.7	37.5	10.8	0.18	10
STMT89943-8B	Ratcheting Wrench 18 mm	18	234.1	39.1	32.9	39.3	11.2	0.2	10
STMT89944-8B	Ratcheting Wrench 19 mm	19	246.1	41.3	34	40.5	11.6	0.222	10

ADJUSTABLE WRENCH

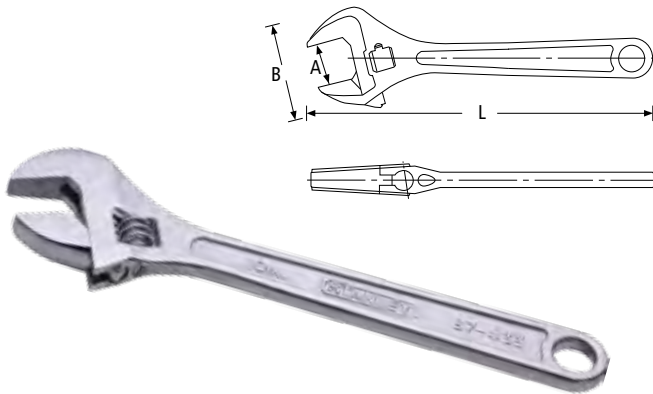

- ASME B107.100, ASME B107.8
- Adjustable jaw design allows tool to grip many fastener sizes
- Knurl adjusting mechanism for quick and precise adjustments
- Built-in tension spring stabilizes movable jaw
- Forged chrome vanadium steel is strong and durable
- Polished chrome head and chrome-plated body for anti-corrosion protection
- Laser-etched SAE and mm jaw scale for easy size adjustment
- Lightweight handle design



SKU #	Description	A (mm)	L (mm)	B (mm)	Weight (kg)	Box Qty
87-430-1-5	Adj. Wrench 100mm	-	100mm / 4"	-	-	6
STMT87431-8	Adj. Wrench 150mm	≤19.3	150mm / 6"	19	0.14	6
STMT87432-8	Adj. Wrench 200mm	≤24	200mm / 8"	24	0.28	6
STMT87433-8	Adj. Wrench 250mm	≤30	250mm / 10"	29	0.41	6
STMT87434-8	Adj. Wrench 300mm	≤36	300mm / 12"	34	0.71	6
STMT87435-8	Adj. Wrench 375mm	≤46	375mm / 15"	43	1.42	4

T - HANDLE

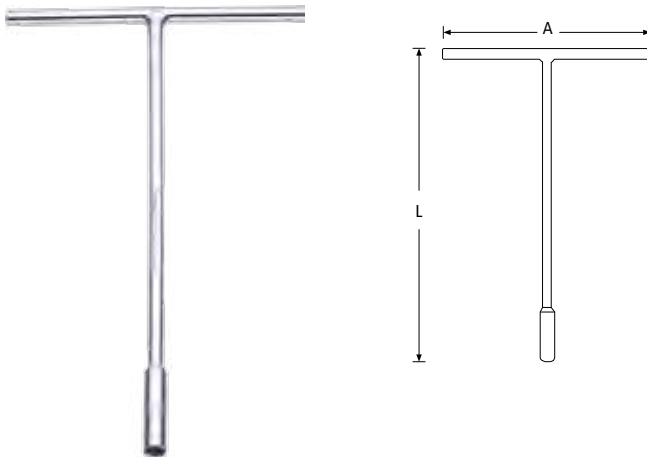

- ASME B107.5M, DIN 3124, ISO 691
- Cr-V steel
- Full polished finishing
- For deep access
- Thin wall socket design



SKU #	Description	Size (mm)	L (mm)	A (mm)	Weight (kg)	Box Qty
STMT93302-8	T-handle 8mm	8	310	200	0.306	10
STMT93303-8	T-handle 9mm	9	310	200	0.312	10
STMT93304-8	T-handle 10mm	10	310	200	0.32	10
STMT93305-8	T-handle 11mm	11	310	200	0.322	10
STMT93306-8	T-handle 12mm	12	310	200	0.326	10
STMT93307-8	T-handle 13mm	13	310	250	0.36	10
STMT93308-8	T-handle 14mm	14	310	250	0.374	10
STMT93309-8	T-handle 17mm	17	310	250	0.552	10
STMT93311-8	T-handle 19mm	19	310	250	0.564	10

WRENCHES PACKAGING OPTIONS

SINGLE, BULK OR TUBE OPTIONS

As you would expect from a global leader in the supply of professional handtools, the **STANLEY® AUTOMOTIVE** range uses the very latest packaging technology to ensure that end users and distributors have a wide choice of buying options.

Designed for durability in transit and display, the new packaging options are more efficient in material usage than ever before - meaning less waste and more recyclable materials.

SINGLE RETAIL PACK

Bold and attractive single packs exploit key features and provide clear user information. Minimal packaging allows full tactile opportunities with security.



BULK PACK

For wholesalers, bulk packs represent great value. Sturdy boxes with bold branding and full EPOS labelling help to keep stock under control. Shipper and promotional packs are also available for some product lines.



TOOL TUBE

For larger environments, the multi tool tubes are the perfect solution. Every pack is clearly marked with key icons and features. This unique packaging helps the product to stand out on the shelf.



STANLEY®

SOCKETS, RATCHETS & MECHANICS TOOL SETS



Tool Sets

Mechanic Tools

Metric Socket

Modules

Ratchets

Sets Sockets

Accessories



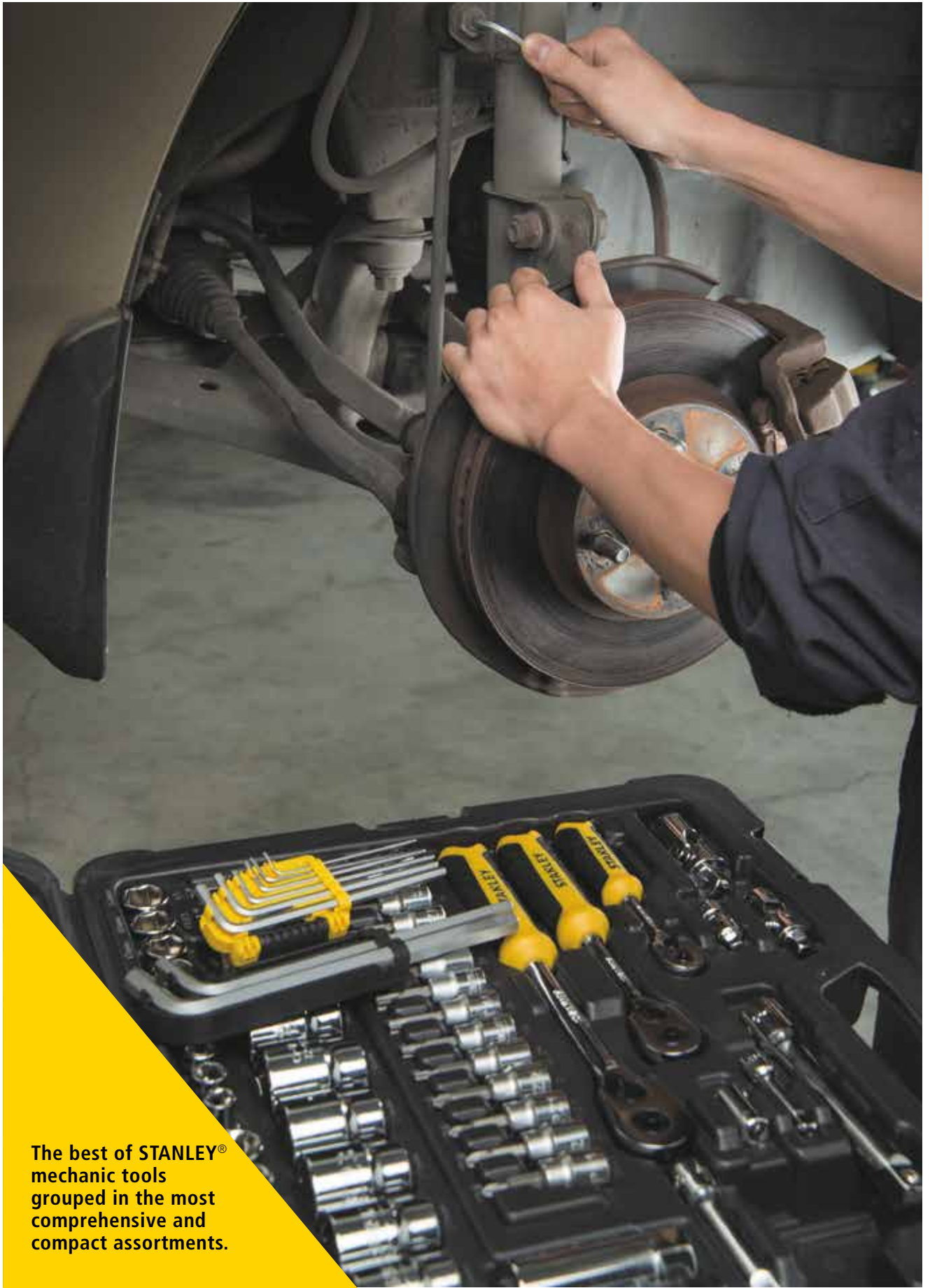

The best of STANLEY®
mechanic tools
grouped in the most
comprehensive and
compact assortments.

SOCKETS, RATCHETS & MECHANICS TOOL SETS

PERFORMANCE IN ACTION

The key tool range in any Automotive repair & maintenance environment the **STANLEY®** Socket & Ratchet range provides professionals with real versatility. Full drive options of 1/4", 1/2" and 3/4" means that you can handle any job - large or small. The unique **Maxi-Drive™** precision profiled Chrome Vanadium Sockets with 6 or 12 point drive, means that every nut or bolt is gripped securely to give a solid torque with minimal wear on head corners.

Mechanics tool sets are a convenient collection of sizes to suit most applications. Sets come complete with a full set of extension bars and couplers for versatile applications.

Accompanying the Hand Socket range, is a selection of S2 grade steel Bit Sockets including Torx, Tamper Torx, Phillips, Pozidriv, Slot and Spline profiles - a tool for every task.

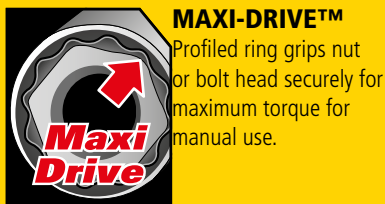

MAXI-DRIVE™
Profiled ring grips nut or bolt head securely for maximum torque for manual use.

ROUND HEAD RATCHET

P7 RATCHET

NP9 COMPACT RATCHET



As with all **STANLEY® AUTOMOTIVE** products, the range is manufactured to the highest standards, exceeding current **ANSI** standards by half, to give you all the reassurance of a dependable working partner.

KEEPING THE JOB ON TRACK

The range incorporates 3 Ratchet options designed for quick and easy use. Each ratchet includes a quick release button - for fast changeovers whilst the Bi-material handles on the P7 and P9 models making them convenient and comfortable in use.

BULK PACK













For wholesalers, bulk packs represent great value. Sturdy boxes with bold branding and full EPOS labelling help to keep stock under control.



RATCHET RANGE OVERVIEW

Ratchet Model		Round Head			P7			NP9 / P9 Ultra Compact		
Drive Size		1/4"	1/2"	3/4"	1/4"	1/2"	3/4"	1/4"	1/2"	3/4"
RATCHET FEATURE	Quick Release	●			●			●		
	No. of Teeth	45			54			60		
	Ratchet Increment	8°			6.7°			6°		

SOCKET RANGE OVERVIEW

	Profile		Standard	Deep	Drive Size			
					1/4"	3/8"	1/2"	3/4"
SOCKET	6PT		●		3.5 - 14(mm)	6 - 24(mm)	8 - 36(mm)	19 - 50(mm)
	6PT			●	4 - 14(mm)	8 - 22(mm)	10 - 32(mm)	-
	12PT		●		6 - 14(mm)	6 - 24(mm)	8 - 36(mm)	19 - 60(mm) 3/4" - 2"
	12PT			●	6 - 14(mm)	8 - 22(mm)	10 - 32(mm)	-
	Torx		●		E4 - E10	E10 - E16	E10 - E24	-
BIT SOCKET	Hex		●	●	2 - 8(mm)	4 - 12(mm)	4 - 19(mm) 4 - 12(mm)	-
	Torx		●	●	T6 - T40	T8 - T55	T20 - T60 T30 - T60	-
	Tamper Torx		●		TT8 - TT40	-	TT10 - TT60	-
	Spline		●	●	-	-	M5 - M16	-
	Phillips		●		PH1 - PH3	PH1 - PH4	-	-
	Pozidriv		●		PZ1 - PZ3	PZ1 - PZ4	-	-
	Slot		●		4 - 7(mm)	5.5 - 8(mm)	-	-

MULTI TOOL SET - 125 PCS

NEW
 1/4" 3/8" 1/2"
 COMPREHENSIVE
 MULTI TOOL SET

1/4" 3/8" 1/2" COMPREHENSIVE MULTI TOOL SET



Blow moulded case for protection



6-24V test pencil



Adjustable oil filter wrench



Impact screwdriver

For different torque levels

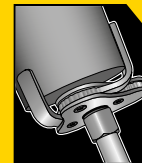

125 PIECE SET CONTENTS:

- Slim Line Combination Wrench(CWE) 8, 10, 12, 13, 14, 16, 17, 18, 19mm
- Test pencil
- 2-Way Oil-filter wrench 63-102mm
- 1/4" 6PTS Standard socket 3.5, 4, 4.5, 5, 5.5, 6, 7, 8mm
- 1/4" 6PTS Deep socket 5, 6, 7, 8mm
- 1/4" Extension 2"
- 1/4" Bits driver
- 1/4" Universal joint
- 1/4" Bits holder
- 1/4" Pear head ratchet NP9
- 1/4" Resistorx bit TT10, TT15, TT20, TT25, TT27, TT30, TT40
- 1/4" Hexagon bit 3, 4, 5, 6mm
- 1/4" Slotted bit 4, 5, 6.5mm
- 1/4" Phillips bit PH1, PH2, PH3
- 1/4" Pozidriv bit PZ1, PZ2, PZ3
- 3/8" 6PTS Standard socket 9, 10, 11, 12, 13, 14, 15, 16, 17mm
- 3/8" 6PTS Deep socket 10, 12, 13, 14, 15, 17mm
- 3/8" Pear head ratchet NP9
- 3/8" Torx socket E6, E8, E10, E11, E12, E14, E16, E18
- 3/8" Spark Plug 14, 16, 21mm
- 3/8" Extension 3", 10"
- 3/8" Universal joint
- 3/8" 3-way coupler 3/8" F x 1/4" M, 3/8" F x 1/2" M
- 3/8" Torx bit socket T-20, T-30, T-40, T-45, T-50, T-55
- 3/8" Hexagon Bit Socket 3, 4, 5, 6mm
- 3/8" Phillips Bit Socket PH1, PH2
- 3/8" Pozidriv Bit Socket PZ1, PZ2
- 3/8" Slotted Bit Socket 5.5, 6.5mm
- 1/2" 6PTS Standard socket 18, 19, 20, 21, 22, 23, 24, 27, 30, 32mm
- 1/2" Pear head ratchet NP9
- 1/2" Universal joint
- 1/2" Extension 5", 10"
- 9PCS Long hex key
- Phillips screwdriver PH2 x 100mm
- Slotted screwdriver 6 x 100mm
- Long Nose Pliers 6"
- Combination Pliers 8"
- Slip Joint Pliers 8"

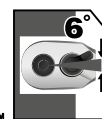

SKU #	Description	L (mm)	W (mm)	H (mm)	Weight (kg)
STMT74393-8	125PCS Multi-Tool Set	526	355	96	10.1

MULTI TOOL SET - 71 PCS

NEW

1/4" 3/8" COMPREHENSIVE MULTI TOOL SET



Blow moulded case for protection



Impact screwdriver



71 PIECE SET CONTENTS:

- Slim Line Combination Wrench(CWE) 8, 10, 12, 13, 14, 16, 17, 18, 19mm
- 1/4" 6PTS Standard Socket 4, 4.5, 5, 5.5, 6, 7, 8mm
- 1/4" 6PTS Deep Socket 5, 6, 7, 8mm
- 1/4" Extension 2"
- 1/4" Torx bits T10, T15, T20, T30, T40
- 1/4" Phillips bit PH1,PH2,PH3
- 1/4" Slotted bit 4,5,5,6,5mm
- 1/4" Bits driver
- 1/4" Bit holder
- 1/4" Universal joint
- 1/4" Pear head ratchet NP9
- 3/8" 6PTS Standard Socket 9,10,11,12,13,14, 15,16,17,18,19,20,21,22,24mm
- 3/8" 6PTS Deep Socket 10,12, 13, 14, 15, 17, 19, 21mm
- 3/8" Spark plug 16, 21mm
- 3/8" Extension 3"
- 3/8" Extension 10"
- 3/8" Universal joint
- 3/8" 3-Way Coupler 3/8"F x 1/4"M
- 3/8" SD Pear head ratchet NP9
- Phillips screwdriver PH2 x 100mm
- Slotted screwdriver 6 x 100mm
- Long nose plier 6"
- Combination plier 8"
- Slip-joint plier 8"

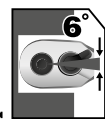

SKU #	Description	L (mm)	W (mm)	H (mm)	Weight (kg)
STMT74394-8	71PCS Multi-Tool Set	144	50	96	6.2

1/4" SOCKET SET & BIT SOCKET - 42 PCS



- 1/4" 6 PTS Standard socket 3.5, 4, 4.5, 5, 5.5, 6, 7, 8, 9, 10, 11, 12, 13, 14mm
- 1/4" Magnetic pick up socket
- 1/4" Extension 50mm
- 1/4" Extension 100mm
- 1/4" Universal joint
- 1/4" Bit holder
- 1/4" Spinner
- 1/4" Pear head ratchet P9
- 1/4" Phillips bits PH1, PH2, PH3
- 1/4" Pozidriv bits PZ1, PZ2, PZ3
- 1/4" Slotted head bits: 4, 5.5, 7
- 1/4" Hex bits 3, 4, 5, 6, 8
- 1/4" Torx bits T10, T15, T20, T25, T30, T40
- 3-Way Coupler 3/8" to 1/4"



SKU #	Description	L (mm)	W (mm)	H (mm)	Weight (kg)
STMT72793-8	42 PCS 1/4" Dr. Socket & Bit Set	144	50	96	1

1/4" SOCKET SET & BIT SOCKET - 46 PCS



- 1/4" 6 PT Standard socket 4, 4.5, 5, 5.5, 6, 7, 9, 10, 11, 12, 13, 14mm
- 1/4" Extension 50mm
- 1/4" Extension 100mm
- 1/4" Sliding tee
- 1/4" Universal joint
- 1/4" Flexible extension 150mm
- 1/4" Spinner
- 1/4" Pear head ratchet P9
- 4PCS Hex key set
- 1/4" Hexagonal bits socket 3, 4, 5, 6, 7, 8mm
- 1/4" Torx bits socket T8, T10, T15, T20, T25, T30, T40
- 1/4" Phillips bits socket PH1, PH2, PH3
- 1/4" Pozidriv bits socket PZ1, PZ2, PZ3
- 1/4" Slotted bits socket 4, 5.5, 7mm



SKU #	Description	L (mm)	W (mm)	H (mm)	Weight (kg)
STMT72794-8	46 PCS 1/4" Dr. Socket & Bit Set	144	50	118	1.25

35-PIECE 1/4" DRIVE SOCKET SET



- METRIC
- **13 pcs 1/4" dr 6 pt sockets :**
4, 4.5, 5, 5.5, 6, 7, 8, 9, 10, 11, 12, 13, 14mm
 - **5 pcs 1/4" dr accessories :**
1 Spinner handle, 2 Extensions: 75, 150mm,
1 Universal joint, 1 Hex bit holder
 - **4 Hex bits : 3, 4, 5, 6mm, 6 Torx® bits :**
T10, 15, 20, 25, 30, 40
3 Posidriv bits : 1, 2, 3, and 3 Slotted bits: 4, 5.5, 6.5mm
 - 1 pc Quick release ratchet pear head
 - 1 Blow-mould case

SKU #	Description	Weight (kg)	Box/CTN
89-033-1	35-Piece 1/4" Drive Socket Set	1.2	1/16

37-PIECE 1/4" & 3/8" DRIVE SOCKET SET



- METRIC
- **9 pcs 1/4" dr 6 pt sockets :**
4, 5, 6, 7, 8, 9, 10, 11, 12mm
 - **9 pcs 3/8" dr 12 pt sockets :**
8, 10, 11, 12, 13, 14, 16, 17, 19mm
- INCH
- **9 pcs 1/4" dr 6 pt sockets :**
3/16, 7/32, 1/4, 9/32, 5/16, 11/32, 3/8, 7/16, 1/2"
 - **7 pcs 3/8" dr 12 pt sockets :**
3/8, 7/16, 1/2, 9/16, 5/8, 11/16, 3/4"
 - **2 pcs 3/8" dr accessories :**
1 Adapter, 1 1/4" dr spinner handle
 - 1 "Full Polish" Quick release ratchet
 - 1 Metal box

SKU #	Description	Weight (kg)	Box/CTN
89-518-1	37-Piece 1/4" & 3/8" Drive Socket Set	5.14	2/2

24-PIECE 3/8" DRIVE SOCKET SET



- METRIC
- **19 pcs 3/8" dr 6 pt sockets :**
6, 7, 8, 9, 10, 11, 12, 13, 14, 15, 16, 17, 18, 19, 20, 21, 22, 23, 24mm
 - **4 pcs 3/8" dr accessories :**
2 Extensions: 75, 150mm, 1 Universal joint, 1 Sliding T-bar
 - 1 pc 3/8" Quick release ratchet pear head
 - 1 Blow-mold case

SKU #	Description	Weight (kg)	Box/CTN
89-035-1	24-Piece 3/8" Drive Socket Set	3	1/8

27-PIECE 1/2" DRIVE SOCKET SET



- INCH
- **20 pcs 1/2" dr 12 pt sockets :**
1/4, 5/16, 3/8, 7/16, 1/2, 9/16, 19/32, 5/8, 11/16, 3/4,
25/32, 13/16, 7/8, 15/16, 31/32, 1, 1-1/16, 1-1/18, 1-3/16, 1-1/4"
 - **5 pcs 1/2" dr accessories :**
2 Extension bar: 5" & 10", 1 Universal joint,
1 Spark plug socket 6 pt 13/16", 1 Sliding T-Bar: 9.5"
 - 1 pc Flip-drive ratchet
 - 1 Blow-mold case

SKU #	Description	Weight (kg)	Box/CTN
86-478	27-Piece 1/2" Drive Socket Set	4.59	4/4

19-PIECE 3/4" DRIVE SOCKET SET



- METRIC
- **15 pcs 3/4" dr 12 pt sockets :**
22, 24, 27, 28, 29, 30, 32, 33, 34, 36, 38, 41, 42, 46, 50mm
 - **3 pcs 3/4" dr accessories :**
2 Extension 100 & 200mm, 1 Sliding T-bar 250mm
 - 1 pc Standard ratchet
 - 1 Blow-mold case

SKU #	Description	Weight (kg)	Box/CTN
89-101	19-Piece 3/4" Drive Socket Set	13	1/1

21 PCS 1/4" DRIVE SOCKET SET



- METRIC
- **8 pcs 1/4" dr 6 pt sockets :**
5, 6, 7, 8, 10, 11, 12, 13mm
- INCH
- **8 pcs 1/4" dr 6 pt sockets :**
3/16, 7/32, 1/4, 9/32, 5/16, 3/8, 7/16, 1/2"
 - **4 pcs 1/4" dr accessories :**
2 Extension bar: 2" & 6", 1 Universal joint, 1 Spinner handle

SKU #	Description	Weight (kg)	Box/CTN
89-507	21-Piece 1/4" Drive Socket Set	4.58	4

16-PIECE 1/2" DRIVE SOCKET SET



- METRIC
- **13 pcs 1/2" dr 12 pt sockets :**
8, 10, 11, 12, 13, 14, 16, 17, 18, 19, 21, 22, 24mm
 - **2 pcs 1/2" dr accessories :**
125mm Extension bar, Universal joint
 - 1 pc 1/2" Quick release ratchet pear head
 - 1 Blow-mould case

SKU #	Description	Weight (kg)	Box/CTN
89-092-1	16-Piece 1/2" Drive Socket Set	3	1/6

27-PIECE 1/2" DRIVE SOCKET SET



- METRIC
- **20 pcs 1/2" dr 12 pt sockets :**
10, 11, 12, 13, 14, 15, 16, 17, 18, 19, 20, 21, 22, 23, 24, 25, 26, 27, 30, 32mm
 - **5 pcs 1/2" dr accessories :**
2 Extension bar: 5" & 10", 1 Universal joint,
1 Spark plug socket 6pt 13/16", 1 sliding T-Bar: 9.5"
 - 1 pc Flip-drive ratchet
 - 1 Blow-mold case

SKU #	Description	Weight (kg)	Box/CTN
86-477	27-Piece 1/2" Drive Socket Set	4.55	1/4

43-PIECE 1/2" DRIVE SOCKET SET



- METRIC**
- **20 pcs 1/2" dr 12 pt sockets :**
10, 11, 12, 13, 14, 15, 16, 17, 18, 19, 20, 21, 22, 23, 24, 26, 27, 28, 30, 32mm
- INCH**
- **15 pcs 1/2" dr 12 pt sockets :**
3/16, 7/16, 1/2, 9/16, 5/8, 11/16, 3/4, 13/16, 7/8, 15/16, 1, 1-1/16, 1-1/8, 1-3/16, 1 1/4"
 - **7 pcs 1/2" dr accessories :**
2 Spark plug 6pt socket: 5/8" & 13/16",
3 Extension bar: 3", 5" & 10", 1 Universal joint,
1 Flex handle: 375mm
 - 1 pc "Full Polish" Quick release ratchet
 - 1 Metal box

SKU #	Description	Weight (kg)	Box/CTN
89-509	43-Piece 1/2" Drive Socket Set	7.86	2/2

25-PIECE 1/2" DRIVE SOCKET SET



- METRIC**
- **7 pcs 1/2" dr 6 pt sockets :**
10, 11, 12, 13, 14, 15, 17, 18, 19, 20, 21, 22, 23, 24, 27, 30, 32mm
 - **6 pcs 1/2" dr accessories:**
1 Spark plug socket, 1 Sliding T-Bar: 10",
1 Universal joint, 1 Flex handle: 17", 2 Extension bar: 5" & 10"
 - 1 pc "Fully polished" Quick release ratchet
 - 1 Blow-mold case

SKU #	Description	Weight (kg)	Box/CTN
86-589-1	25-Piece 1/2" Drive Socket Set	5.8	1/4

27-PIECE 1/2" DRIVE SOCKET SET



- METRIC**
- **20 pcs 1/2" dr 6 pt sockets :**
10, 11, 12, 13, 14, 15, 16, 17, 18, 19, 20, 21, 22, 23, 24, 25, 26, 27, 30, 32mm
 - **5 pcs 1/2" dr accessories :**
2 Extension bar: 5" & 10", 1 Universal joint,
1 Spark plug socket 6pt 13/16", 1 sliding T-Bar: 9.5"
 - 1 pc Flip-drive ratchet
 - 1 Blow-mold case

SKU #	Description	Weight (kg)	Box/CTN
86-477-6	27-Piece 1/2" Drive Socket Set	4.55	1/4

23 PCS 1/2" 12PT FLEX WRENCH METRIC SOCKET MODULE SET



- 1/2" SD pear head ratchet p9,
- 1/2" Extension 125mm,
- 1/2" Extension 250mm,
- 1/2" Universal joint,
- 1/2" 12 pt standard socket 8mm - 32mm,
- Flex socket wrench 10*11mm,
- 16" Tool case

SKU #	Description	Width (mm)	Length (mm)	Height (mm)	Weight (kg)
STMT75095-8C	23pcs 1/2" 12PT Flex Wrench Metric Socket Module Set	290	405	60	3.76

1/4", 3/8", 1/2" ROUND HEAD RATCHET

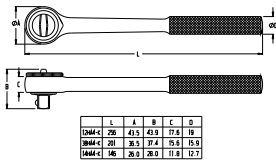

- Full polish finish, double-nickel with chrome plating for extra rust resistance and prolonged life
- Round head ratchet for tight access area
- Anti-slip and durable knurled metal handle design suit most industrial applications
- Flip drive ratchet head for easy directional rotation

SKU #	Description	L (mm)	A (mm)	B (mm)	C (mm)	D (mm)	Weight (kg)	Box/CTN
87-710-1	1/4" Round Head Ratchet	146	26.0	28.0	11.8	12.7	150	4/48
87-715-1	3/8" Round Head Ratchet	201	36.5	37.4	15.6	15.9	370	4/48
87-720-1	1/2" Round Head Ratchet	256	43.5	43.9	17.6	19.0	620	4/48

1/4", 3/8", 1/2" FLEX HANDLE BAR

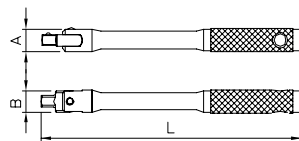

- ISO 3315 / DIN 3122 (1/4" - 1/2")
- ISO 1174 / DIN 3120 (3/4")
- Made of Chrome-Vanadium Steel
- For applications where high leverage is needed to tighten or release a fastener

SKU #	Description	L (mm)	A (mm)	B (mm)	Weight (g)	Box/CTN
86-012-1	1/4" Flex Handle Bar	147	12.7	12	92	6/48
86-213-1	3/8" Flex Handle Bar	215.5	21	17	270	6/96
86-413-1	1/2" Flex Handle Bar	439	28	20.1	713	6/36
86-405-1	1/2" Flex Handle Bar	254	28	21	485	4/32
86-415-1	1/2" Flex Handle Bar	381	28	21	646	6/24
89-302-1	3/4" Flex Handle Bar215.	500	41	34	1850	2/16

60 PCS 1/4" METRIC SOCKET SET

NEW
 60 PCS 1/4" METRIC SOCKET SET
 60 PCS 1/4" METRIC SOCKET SET
 60 PCS 1/4" METRIC SOCKET SET



COMPATIBLE with
**TRANS
 MODULE**
 system

16" TOOL SET CASE + MODULE :

- 1/4" 6PTS Standard socket 4, 4.5, 5, 5.5, 6, 7, 8, 9, 10, 11, 12, 13, 14mm
- 1/4" 6PTS Deep socket 4, 5, 5.5, 6, 7, 8, 9, 10, 11, 12, 13, 14mm
- 1/4" Hexagon bit socket 2, 2.5, 3, 4, 5, 6mm
- 1/4" Bit socket slot 4, 5.5, 7mm
- 1/4" Bit socket PZ1, PZ2, PZ3
- 1/4" Bit socket PH1, PH2, PH3
- 1/4" Torx bit socket T6, T7, T8, T9, T10, T15, T20, T25
- 1/4" Torx socket E4, E5, E6, E7, E8, E10
- 1/4" Pear head ratchet NP9
- 1/4" Spinner
- 1/4" Extension 50, 100mm



SKU #	Description	L (mm)	W (mm)	H (mm)	Weight (kg)	Box Qty
STMT74175-8C	60 PCS 1/4" Metric Socket Set	405	290	60	2.26	1

1/4" METRIC SOCKET MODULE - 60 PCS

NEW
 60 PCS 1/4" METRIC SOCKET MODULE
 60 PCS 1/4" METRIC SOCKET MODULE
 60 PCS 1/4" METRIC SOCKET MODULE



COMPATIBLE with
**TRANS
 MODULE**
 system

- 1/4" 6PTS Standard socket 4, 4.5, 5, 5.5, 6, 7, 8, 9, 10, 11, 12, 13, 14mm
- 1/4" 6PTS Deep socket 4, 5, 5.5, 6, 7, 8, 9, 10, 11, 12, 13, 14mm
- 1/4" Hexagon bit socket 2, 2.5, 3, 4, 5, 6mm
- 1/4" Bit socket slot 4, 5.5, 7mm
- 1/4" Bit socket PZ1, PZ2, PZ3
- 1/4" Bit socket PH1, PH2, PH3
- 1/4" Torx bit socket T6, T7, T8, T9, T10, T15, T20, T25
- 1/4" Torx socket E4, E5, E6, E7, E8, E10
- 1/4" Pear head ratchet NP9
- 1/4" Spinner
- 1/4" Extension 50, 100mm
- 1/4" Universal joint
- 1/4" Sliding tee



SKU #	Description	Length (mm)	Width (mm)	Height (mm)	Carton Qty
STMT74175-8	60 PCS 1/4" Metric Socket Module	384	184	45	4

1/4" PEAR HEAD RATCHET NP9

NEW
 2017
 2018
 2019
 2020
 2021
 2022
 2023
 2024

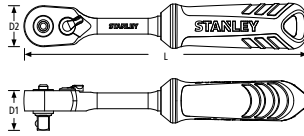

- ASME B107.10M-2005, ISO 3315, DIN 3122, ISO 1174-1
- Socket safety lock
- Lever reverse: rotation direction displayed
- Chrome vanadium steel
- Chemical resistant ergonomic bimaterial handle
- Quick release button



Retail SKU #	BULK SKU #	Description	L (mm)	D1 (mm)	D2 (mm)	Gear	Increment	Weight (kg)	Retail / BULK Box Qty
STMT73982-8	STMT73982-8B	1/4" Pear Head Ratchet NP9	146	22.4	22.1	60	6°	0.1	10 / 8

1/4" PEAR HEAD RATCHET P7

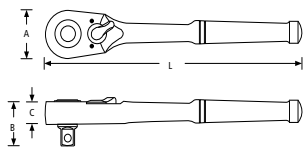

- ASME B107.10M-2005, ISO 3315, DIN 3122, ISO 1174-1
- Socket safety lock
- Lever reverse: rotation direction displayed
- Chrome vanadium steel
- Quick release button



SKU #	Description	L (mm)	D1 (mm)	D2 (mm)	Gear	Increment	Weight (kg)	Box Qty
STMT89817-8B	1/4" Pear Head Ratchet P7	136	24.5	22.4	54	6.7°	0.132	8

1/4" ROUND HEAD RATCHET

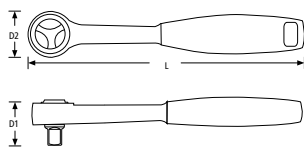

- ASME B107.10M-2005, ISO 3315, DIN 3122, ISO 1174-1
- Socket safety lock
- Chrome vanadium steel
- Quick release button



SKU #	Description	L (mm)	D1 (mm)	D2 (mm)	Gear	Increment	Weight (kg)	Box Qty
STMT86395-8B	1/4" Round Head Ratchet	160	21	28	45	8°	0.151	4

1/4" SLIDING TEE

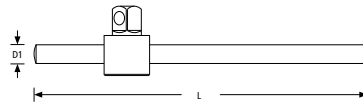

- ASME B107.10M, ISO 3316 - DIN 3123 - ISO 1174-1
- Sliding Head
- Chrome vanadium steel
- For manual use



SKU #	Description	L (mm)	D1 (mm)	Weight (kg)	Box Qty
STMT86010-8B	1/4" Sliding Tee	108	6.4	0.041	10

1/4" EXTENSION

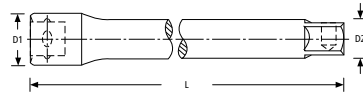

- ASME B107.10M, ISO 3316 - DIN 3123 - ISO 1174-1
- Full polished finishing
- Chrome vanadium steel
- For manual use



SKU #	Description	L (mm)	D1 (mm)	D2 (mm)	Weight (kg)	Box Qty
STMT91059-8B	1/4" Extension 50mm	51	12.5	8.2	0.025	11
STMT86006-8B	1/4" Extension 75mm	76.2	12.5	8.2	0.035	33
STMT91339-8B	1/4" Extension 100mm	101.6	12.5	8.2	0.045	33
STMT86007-8B	1/4" Extension 150mm	152.4	12.5	8.2	0.067	10

1/4" FLEXIBLE EXTENSION

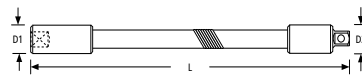

- ASME B107.10M, ISO 3316 - DIN 3123 - ISO 1174-1
- Full polished finishing
- Chrome vanadium steel
- For manual use



SKU #	Description	L (mm)	D1 (mm)	D2 (mm)	Weight (kg)	Box Qty
STMT86001-8B	1/4" Flexible Extension 150mm	150	12.2	12.2	0.064	10

1/4" MAGNETIC PICK UP SOCKET

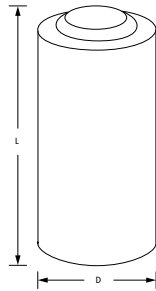

- ISO 1174-1, ISO 691
- Chrome vanadium steel
- For manual use



SKU #	Description	L (mm)	D (mm)	Weight (kg)	Box qty
STMT73082-8B	Magnetic Pick Up Socket	26.2	11.8	0.015	18

1/4" BIT HOLDER

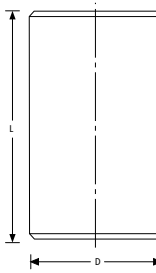

- ASME B107.10M
- For manual use



SKU #	Description	L (mm)	D (mm)	Weight (kg)	Box Qty
STMT86124-8B	1/4" Bit Holder	25.2	14.2	0.024	15

1/4" COUPLER

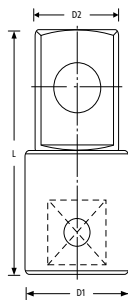

- ASME B107.10M, ISO 1174-1, ISO 691
- Chrome vanadium steel
- For manual use.



SKU #	Description	L (mm)	D1 (mm)	D2 (mm)	Weight (kg)	Box Qty
STMT86002-8B	Coupler 1/4" To 3/8"	25	12.2	10	0.016	15

1/4" UNIVERSAL JOINT

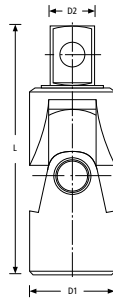

- ASME B107.10M, ISO 1174-2
- Chrome vanadium steel
- For manual use



SKU #	Description	L (mm)	D1 (mm)	D2 (mm)	Weight (kg)	Box Qty
STMT86011-8B	1/4" Universal Joint	34	14	6.3	0.0218	8

1/4" 6PTS STANDARD SOCKET

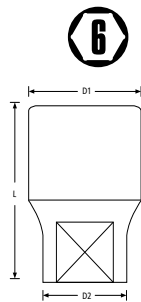

- ASME B107.5M, DIN 3124, ISO 1174-1, ISO 1711-1, ISO 691
- Maxi-Drive™ system helps reduce fastener rounding
- Chrome vanadium steel
- For manual use



SKU #	Description	L (mm)	D1 (mm)	D2 (mm)	Weight (kg)	Box Qty
STMT72872-8B	1/4" 6 PTS Standard Socket 3.5mm	25	12	6.4	0.010	18
STMT72873-8B	1/4" 6 PTS Standard Socket 4mm	25	12	6.9	0.010	18
STMT72874-8B	1/4" 6 PTS Standard Socket 4,5mm	25	12	7.5	0.011	18
STMT72875-8B	1/4" 6 PTS Standard Socket 5mm	25	12	8.1	0.010	18
STMT72876-8B	1/4" 6 PTS Standard Socket 5,5mm	25	12	8.8	0.010	18
STMT72877-8B	1/4" 6 PTS Standard Socket 6mm	25	12	9.4	0.011	18
STMT72878-8B	1/4" 6 PTS Standard Socket 7mm	25	12	10.9	0.012	18
STMT72879-8B	1/4" 6 PTS Standard Socket 8mm	25	12	11.5	0.012	18
STMT72880-8B	1/4" 6 PTS Standard Socket 9mm	25	13.2	12	0.015	15
STMT72881-8B	1/4" 6 PTS Standard Socket 10mm	25	14.7	13	0.020	15
STMT72882-8B	1/4" 6 PTS Standard Socket 11mm	25	16	13	0.023	13
STMT72883-8B	1/4" 6 PTS Standard Socket 12mm	25	16.9	13.5	0.025	8
STMT72884-8B	1/4" 6 PTS Standard Socket 13mm	25	14.7	14	0.028	8
STMT72885-8B	1/4" 6 PTS Standard Socket 14mm	25	19.7	16	0.036	8

1/4" 12PTS STANDARD SOCKET

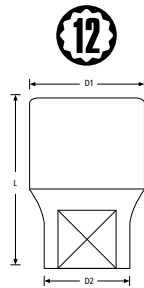

- ASME B107.5M, DIN 3124, ISO 1174-1, ISO 1711-1, ISO 691
- Maxi-Drive™ system helps reduce fastener rounding
- Chrome vanadium steel
- For manual use



SKU #	Description	L (mm)	D1 (mm)	D2 (mm)	Weight (kg)	Box Qty
STMT72887-8B	1/4" 12 PTS Standard Socket 7mm	25	12	10.9	0.012	18
STMT72888-8B	1/4" 12 PTS Standard Socket 8mm	25	12	11.5	0.012	18
STMT72889-8B	1/4" 12 PTS Standard Socket 9mm	25	12	12	0.015	15
STMT72890-8B	1/4" 12 PTS Standard Socket 10mm	25	12	13	0.020	15
STMT72891-8B	1/4" 12 PTS Standard Socket 11mm	25	12	13	0.023	13
STMT72892-8B	1/4" 12 PTS Standard Socket 12mm	25	12	13.5	0.025	8
STMT72893-8B	1/4" 12 PTS Standard Socket 13mm	25	12	14	0.028	8
STMT72894-8B	1/4" 12 PTS Standard Socket 14mm	25	13.2	16	0.035	8

1/4" 6PTS DEEP SOCKET

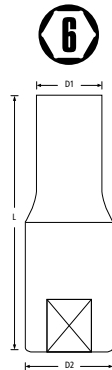

- ASME B107.5M, ISO 1174-1, ISO 1711-1, ISO 691
- Maxi-Drive™ system helps reduce fastener rounding
- Chrome vanadium steel
- For manual use



SKU #	Description	L (mm)	D1 (mm)	D2 (mm)	Weight (kg)	Box Qty
STMT73197-8B	1/4" 6 PTS Deep Socket 4mm	49.5	11.8	6.9	0.021	18
STMT73198-8B	1/4" 6 PTS Deep Socket 5mm	49.5	11.8	8	0.021	18
STMT73199-8B	1/4" 6 PTS Deep Socket 5,5mm	49.5	11.8	8.8	0.022	18
STMT73200-8B	1/4" 6 PTS Deep Socket 6mm	49.5	11.8	9.4	0.022	18
STMT73201-8B	1/4" 6 PTS Deep Socket 7mm	49.5	11.8	10.9	0.024	18
STMT73202-8B	1/4" 6 PTS Deep Socket 8mm	49.5	11.8	-	0.026	18
STMT73203-8B	1/4" 6 PTS Deep Socket 9mm	49.5	12.8	-	0.028	15
STMT73204-8B	1/4" 6 PTS Deep Socket 10mm	49.5	14.5	-	0.038	12
STMT73205-8B	1/4" 6 PTS Deep Socket 11mm	49.5	15.6	-	0.043	10
STMT73206-8B	1/4" 6 PTS Deep Socket 12mm	49.5	16.6	-	0.046	8
STMT73207-8B	1/4" 6 PTS Deep Socket 13mm	49.5	17.6	-	0.052	8
STMT73208-8B	1/4" 6 PTS Deep Socket 14mm	49.5	19.6	-	0.068	11

1/4" 12PTS DEEP SOCKET

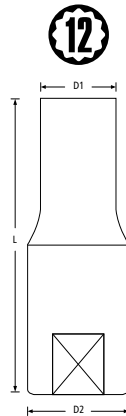

- ASME B107.5M, ISO 1174-1, ISO 1711-1, ISO 691
- Maxi-Drive™ system helps reduce fastener rounding
- Chrome vanadium steel
- For manual use



SKU #	Description	L (mm)	D1 (mm)	D2 (mm)	Weight (kg)	Box Qty
STMT73209-8B	1/4" 12 PTS Deep Socket 6mm	49.5	11.8	9.4	0.022	18
STMT73210-8B	1/4" 12 PTS Deep Socket 7mm	49.5	11.8	10.9	0.024	18
STMT73211-8B	1/4" 12 PTS Deep Socket 8mm	49.5	11.8	-	0.026	18
STMT73212-8B	1/4" 12 PTS Deep Socket 9mm	49.5	12.8	-	0.028	15
STMT73213-8B	1/4" 12 PTS Deep Socket 10mm	49.5	14.5	-	0.038	12
STMT73214-8B	1/4" 12 PTS Deep Socket 11mm	49.5	15.6	-	0.043	10
STMT73215-8B	1/4" 12 PTS Deep Socket 12mm	49.5	16.6	-	0.046	8
STMT73216-8B	1/4" 12 PTS L Deep Socket 13mm	49.5	17.6	-	0.052	8
STMT73217-8B	1/4" 12 PTS Deep Socket 14mm	49.5	19.6	-	0.068	11

1/4" TORX SOCKET

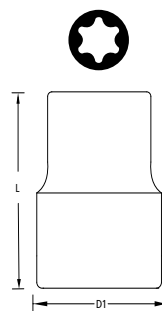

- ISO 1174-1
- For male Torx® screws
- Chrome vanadium steel



SKU #	Description	L (mm)	D1 (mm)	Weight (kg)	Box Qty
STMT73218-8B	1/4" Torx Socket E4	25	12	0.0101	18
STMT73219-8B	1/4" Torx Socket E5	25	12	0.0101	18
STMT73220-8B	1/4" Torx Socket E6	25	12	0.0111	18
STMT73221-8B	1/4" Torx Socket E7	25	12	0.012	18
STMT73222-8B	1/4" Torx Socket E8	25	12	0.0121	18
STMT73224-8B	1/4" Torx Socket E10	25	12	0.014	18

1/4" HEXAGON BIT SOCKET

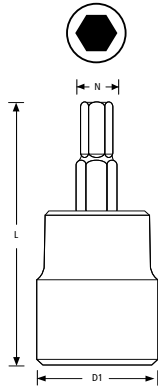

- ISO 1173, ISO 2380-1, ISO 2351-1, ISO 1174-1, ISO 691
- S2 Steel bit
- HRC 60+/-2, 20% higher torque vs Cr-V
- For manual use



SKU #	Description	L (mm)	D1 (mm)	N (mm)	Weight (kg)	Box Qty
STMT73225-8B	1/4" Hexagon Bit Socket 2mm	32	18	2	0.011	12
STMT73226-8B	1/4" Hexagon Bit Socket 2,5mm	32	18	2.5	0.011	12
STMT73227-8B	1/4" Hexagon Bit Socket 3mm	32	18	3	0.011	12
STMT73228-8B	1/4" Hexagon Bit Socket 4mm	32	18	4	0.011	12
STMT73229-8B	1/4" Hexagon Bit Socket 5mm	32	18	5	0.011	12
STMT73230-8B	1/4" Hexagon Bit Socket 6mm	32	18	6	0.011	12
STMT73231-8B	1/4" Hexagon Bit Socket 7mm	32	18	7	0.012	12
STMT73232-8B	1/4" Hexagon Bit Socket 8mm	32	18	8	0.012	12

1/4" TORX BIT SOCKET

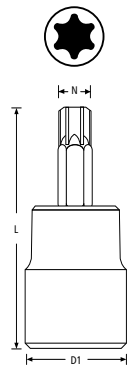

- ISO 1173, ISO 2380-1, ISO 2351-1, ISO 1174-1, ISO 691
- S2 Steel bit
- HRC 60+/-2, 20% higher torque vs Cr-V
- For manual use



SKU #	Description	L (mm)	D1 (mm)	N (mm)	Weight (kg)	Box Qty
STMT73242-8B	1/4" Torx Bit Socket T6	32	18	T6	0.012	12
STMT73243-8B	1/4" Torx Bit Socket T7	32	18	T7	0.013	12
STMT73244-8B	1/4" Torx Bit Socket T8	32	18	T8	0.013	12
STMT73245-8B	1/4" Torx Bit Socket T9	32	18	T9	0.011	12
STMT73246-8B	1/4" Torx Bit Socket T10	32	18	T10	0.013	12
STMT73247-8B	1/4" Torx Bit Socket T15	32	18	T15	0.013	12
STMT73248-8B	1/4" Torx Bit Socket T20	32	18	T20	0.013	12
STMT73249-8B	1/4" Torx Bit Socket T25	32	18	T25	0.015	12
STMT73250-8B	1/4" Torx Bit Socket T27	32	18	T27	0.014	12
STMT73251-8B	1/4" Torx Bit Socket T30	32	18	T30	0.014	12
STMT73252-8B	1/4" Torx Bit Socket T40	32	18	T40	0.014	12

1/4" TAMPER TORX BIT SOCKET

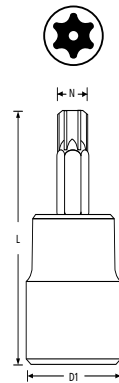

- ISO 1173, ISO 2380-1, ISO 2351-1, ISO 1174-1, ISO 691
- S2 Steel bit
- HRC 60 +/- 2, 20% higher torque vs Cr-V
- For manual use



SKU #	Description	L (mm)	D1 (mm)	A (mm)	Weight (kg)	Box Qty
STMT73253-8B	1/4" Tamper Torx Bit Socket TT8	32	18	TT8	0.014	12
STMT73254-8B	1/4" Tamper Torx Bit Socket TT10	32	18	TT10	0.014	12
STMT73255-8B	1/4" Tamper Torx Bit Socket TT15	32	18	TT15	0.014	12
STMT73256-8B	1/4" Tamper Torx Bit Socket TT20	32	18	TT20	0.014	12
STMT73257-8B	1/4" Tamper Torx Bit Socket TT25	32	18	TT25	0.014	12
STMT73258-8B	1/4" Tamper Torx Bit Socket TT27	32	18	TT27	0.014	12
STMT73259-8B	1/4" Tamper Torx Bit Socket TT30	32	18	TT30	0.015	12
STMT73260-8B	1/4" Tamper Torx Bit Socket TT40	32	18	TT40	0.015	12

1/4" PHILLIPS BIT SOCKET

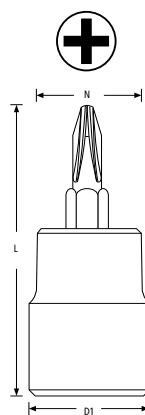

- ISO 1173, ISO 2380-1, ISO 2351-1, ISO 1174-1, ISO 691
- S2 Steel bit
- HRC 60 +/- 2, 20% higher torque vs Cr-V
- For manual use



SKU #	Description	L (mm)	D1 (mm)	N (mm)	Weight (kg)	Box Qty
STMT73236-8B	1/4" Phillips Bit Socket PH1	32	18	PH1	0.011	12
STMT73237-8B	1/4" Phillips Bit Socket PH2	32	18	PH2	0.012	12
STMT73238-8B	1/4" Phillips Bit Socket PH3	32	18	PH3	0.012	12

1/4" SLOTTED BIT SOCKET

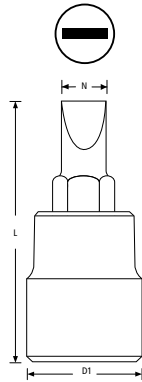

- ISO 1173, ISO 2380-1, ISO 2351-1, ISO 1174-1, ISO 691
- S2 Steel bit
- HRC 60 +/- 2, 20% higher torque vs Cr-V
- For manual use



SKU #	Description	L (mm)	D1 (mm)	N (mm)	Weight (kg)	Box Qty
STMT73233-8B	1/4" Slotted Bit Socket 4mm	32	18	4	0.011	12
STMT73234-8B	1/4" Slotted Bit Socket 5.5mm	32	18	5.5	0.011	12
STMT73235-8B	1/4" Slotted Bit Socket 7mm	32	18	7	0.012	12

1/4" POZIDRIV BIT SOCKET

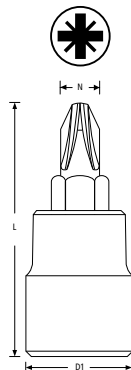

- ISO 1173, ISO 2380-1, ISO 2351-1, ISO 1174-1, ISO 691
- S2 Steel bit
- HRC 60 +/- 2, 20% higher torque vs Cr-V
- For manual use



SKU #	Description	L (mm)	D1 (mm)	N (mm)	Weight (kg)	Box Qty
STMT73239-8B	1/4" Pozidriv Bit Socket PZ1	32	18	PZ1	0.011	12
STMT73240-8B	1/4" Pozidriv Bit Socket PZ2	32	18	PZ2	0.012	12
STMT73241-8B	1/4" Pozidriv Bit Socket PZ3	32	18	PZ3	0.013	12



“ I HAVE BEEN WORKING WITH STANLEY SOCKETS FOR OVER A DECADE AND WE HAVE BEEN THROUGH EVERY IMAGINABLE SCENARIO. THEY HAVE NEVER FAILED ME AND THIS SPEAKS VOLUMES OF THE PRODUCTS' DURABILITY AND HARDINESS. NOT ONLY THAT, THEY STILL LOOK AND FEEL GREAT. ”

3/8" METRIC SOCKET MODULE - 36PCS

NEW
STANLEY
3/8" METRIC SOCKET MODULE
36 PCS



COMPATIBLE with
**TRANS
MODULE**
system

- 3/8" 12PT Standard socket 8, 9, 10, 11, 12, 13, 14, 15, 16, 17, 18, 19, 21, 22mm
- 3/8" 6PT Deep socket 8, 10, 11, 12, 13, 14, 15, 16, 17, 18, 19, 21, 22mm
- 3/8" Hexagon bit socket 4, 5, 6mm
- 3/8" Torx bit socket T25, T30, T40
- 3/8" Extension 125mm
- 3/8" Universal joint
- 3/8" Pear head ratchet NP9



SKU #	Description	Length (mm)	Width (mm)	Height (mm)	Carton Qty
STMT74174-8	36 PCS 3/8" Metric Socket Module	384	184	45	4

3/8" PEAR HEAD RATCHET NP9

NEW
STANLEY
3/8" PEAR HEAD RATCHET NP9

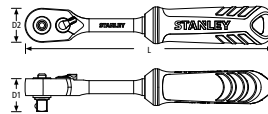

- ASME B107.10M-2005, ISO 3315, DIN 3122, ISO 1174-1
- Socket safety lock
- Lever reverse: rotation direction displayed
- Chrome vanadium steel
- Chemical resistant ergonomic bimaterial handle
- Quick release button



Retail SKU #	BULK SKU #	Description	L (mm)	D1 (mm)	D2 (mm)	Gear	Increment	Weight (kg)	Retail / BULK Box Qty
STMT73983-8	STMT73983-8B	3/8" Pear Head Ratchet NP9	202	27.8	29.51	60	6°	0.23	10 / 10

3/8" PEAR HEAD RATCHET P7

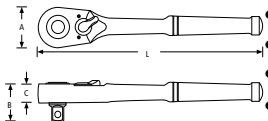

- ASME B107.10M-2005, ISO 3315, DIN 3122, ISO 1174-1
- Socket safety lock
- Lever reverse: rotation direction displayed
- Chrome vanadium steel
- Quick release button



SKU #	Description	L (mm)	D1 (mm)	D2 (mm)	Gear	Increment	Weight (kg)	Box Qty
STMT89818-8B	3/8" Pear Head Ratchet P7	195	32.5	30.8	54	6.7°	0.32	8

3/8" ROUND HEAD RATCHET

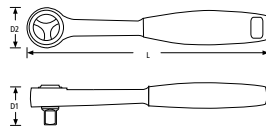

- ASME B107.10M-2005, ISO 3315, DIN 3122, ISO 1174-1
- Socket safety lock
- Chrome vanadium steel
- Quick release button



SKU #	Description	L (mm)	D1 (mm)	D2 (mm)	Gear	Increment	Weight (kg)	Box Qty
STMT86396-8B	3/8" Round Head Ratchet	210	36	37	45	8°	0.347	8

3/8" SLIDING TEE

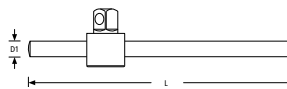

- ASME B107.10M, ISO 3315 - DIN 3122 - ISO 1174-1
- Sliding head
- Chrome vanadium steel
- For manual use



SKU #	Description	L (mm)	D1 (mm)	Weight (kg)	Box Qty
STMT86202-8B	3/8" Sliding Tee	170	9.5	0.133	4

3/8" EXTENSION

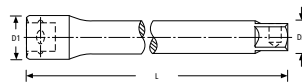

- ASME B107.10M, ISO 3316 - DIN 3123 - ISO 1174-1
- Full polished finishing
- Chrome vanadium steel
- For manual use



SKU #	Description	L (mm)	D1 (mm)	D2 (mm)	Weight (kg)	Box Qty
STMT86206-8B	3/8" Extension 75mm	76.2	17	12.2	0.073	3
STMT86207-8B	3/8" Extension 125mm	152.4	17	12.2	0.145	8
STMT86208-8B	3/8" Extension 250mm	245	17	12.2	0.23	21

3/8" BIT HOLDER

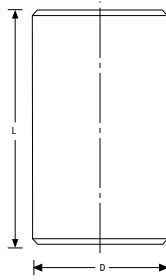

- ASME B107.10, ISO 1174-1, ISO 691
- Chrome vanadium steel
- For manual use



SKU #	Description	L (mm)	D (mm)	Weight (kg)	Box Qty
STMT86250-8B	3/8" Holder For 1/4 Bits	28.6	17.3	0.024	11

3/8" COUPLER

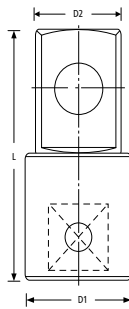

- ASME B107.10M, ISO 1174-1, ISO 691
- Chrome vanadium steel
- For manual use



SKU #	Description	L (mm)	D1 (mm)	D2 (mm)	Weight (kg)	Box Qty
STMT86214-8B	Coupler 3/8" To 1/4"	25.4	17.4	6.3	0.020	12
STMT86215-8B	Coupler 3/8" To 1/2"	36	18	10	0.044	8

3/8" UNIVERSAL JOINT

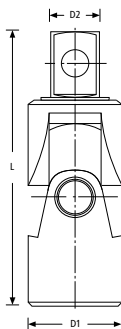

- ASME B107.10M, ISO 1174-2
- Chrome vanadium steel
- For manual use



SKU #	Description	L (mm)	D1 (mm)	D2 (mm)	Weight (kg)	Box Qty
STMT86211-8B	3/8" Universal Joint	54.2	19	10	0.060	8

3/8" SPEED HANDLE

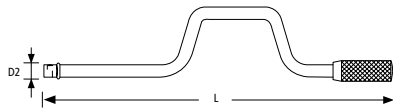

- ASME B107.10M, ISO 3315 - DIN 3122 - ISO 1174-1
- Fast rotation
- Rotating handle
- Knurled handle



SKU #	Description	L (mm)	D2 (mm)	Weight (kg)	Box Qty
STMT86212-8B	3/8" Speed Handle	380	17	0.318	6

3/8" SWIVEL HANDLE

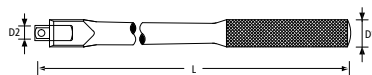

- ASME B107.10M, ISO 3315 - DIN 3122 - ISO 1174-1
- Smooth-action joint
- Hinged handle for easier access
- Knurled handle



SKU #	Description	L (mm)	Weight (kg)	Box Qty
STMT86213-8B	3/8" Swivel Handle 200mm	215.5	0.234	6

3/8" 6PTS SPARK PLUG SOCKET

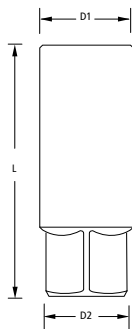

- ASME B107.34M
- Chrome vanadium steel
- For manual use



SKU #	Description	L (mm)	D1 (mm)	D2 (mm)	Weight (kg)	Box Qty
STMT88941-8B	3/8" 6 PTS Spark Plug Socket 16mm	65	22	10	0.097	2

3/8" 6PTS STANDARD SOCKET

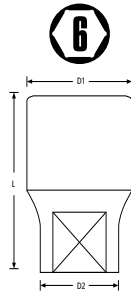

- ASME B107.5M, DIN 3124, ISO 1174-1, ISO 1711-1, ISO 691
- Maxi-Drive™ system helps reduce fastener rounding
- Chrome vanadium steel
- For manual use



SKU #	Description	L (mm)	D1 (mm)	D2 (mm)	Weight (kg)	Box Qty
STMT72914-8B	3/8" 6 PTS Standard Socket 6mm	25.7	17.1	10.1	0.02	12
STMT72915-8B	3/8" 6 PTS Standard Socket 7mm	25.7	17.1	11	0.021	12
STMT72916-8B	3/8" 6 PTS Standard Socket 8mm	25.7	17.1	12.2	0.025	12
STMT72917-8B	3/8" 6 PTS Standard Socket 9mm	25.7	17.1	13.2	0.022	12
STMT72918-8B	3/8" 6 PTS Standard Socket 10mm	25.7	17.1	14.7	0.022	12
STMT72919-8B	3/8" 6 PTS Standard Socket 11mm	25.7	17.1	16	0.024	12
STMT72920-8B	3/8" 6 PTS Standard Socket 12mm	25.7	17.1	16.5	0.024	12
STMT72921-8B	3/8" 6 PTS Standard Socket 13mm	25.7	18.3	17	0.026	12
STMT72922-8B	3/8" 6 PTS Standard Socket 14mm	25.7	19.5	18	0.028	11
STMT72923-8B	3/8" 6 PTS Standard Socket 15mm	25.7	20.4	18	0.028	11
STMT72924-8B	3/8" 6 PTS Standard Socket 16mm	29	22.1	19	0.038	15
STMT72925-8B	3/8" 6 PTS Standard Socket 17mm	29	23.3	19	0.042	14
STMT72926-8B	3/8" 6 PTS Standard Socket 18mm	29	24.2	20	0.046	14
STMT72927-8B	3/8" 6 PTS Standard Socket 19mm	29	25.5	21	0.054	11
STMT72928-8B	3/8" 6 PTS Standard Socket 20mm	29	26.8	22	0.05	10
STMT72929-8B	3/8" 6 PTS Standard Socket 21mm	29	27.7	23	0.056	9
STMT72930-8B	3/8" 6 PTS Standard Socket 22mm	29	29.5	24	0.072	8
STMT72931-8B	3/8" 6 PTS Standard Socket 23mm	29	30.7	25	0.07	8
STMT72932-8B	3/8" 6 PTS Standard Socket 24mm	29	31	26	0.075	7

3/8" 12PTS STANDARD SOCKET

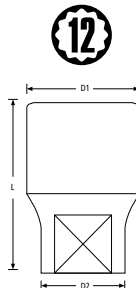

- ASME B107.5M, DIN 3124, ISO 1174-1, ISO 1711-1, ISO 691
- Maxi-Drive™ system helps reduce fastener rounding
- Chrome vanadium steel
- For manual use



SKU #	Description	L (mm)	D1 (mm)	D2 (mm)	Weight (kg)	Box Qty
STMT72895-8B	3/8" 12 PTS Standard Socket 6mm	25.7	17.1	10.1	0.031	12
STMT72896-8B	3/8" 12 PTS Standard Socket 7mm	25.7	17.1	11	0.021	12
STMT72897-8B	3/8" 12 PTS Standard Socket 8mm	25.7	17.1	12.2	0.020	12

SKU #	Description	L (mm)	D1 (mm)	D2 (mm)	Weight (kg)	Box Qty
STMT72898-8B	3/8" 12 PTS Standard Socket 9mm	25.7	17.1	13.2	0.022	12
STMT72899-8B	3/8" 12 PTS Standard Socket 10mm	25.7	17.1	14.7	0.022	12
STMT72900-8B	3/8" 12 PTS Standard Socket 11mm	25.7	17.1	16	0.024	12
STMT72901-8B	3/8" 12 PTS Standard Socket 12mm	25.7	17.1	16.5	0.024	12
STMT72902-8B	3/8" 12 PTS Standard Socket 13mm	25.7	18.3	17	0.026	12
STMT72903-8B	3/8" 12 PTS Standard Socket 14mm	25.7	19.5	18	0.028	11
STMT72904-8B	3/8" 12 PTS Standard Socket 15mm	25.7	20.4	18	0.032	11
STMT72905-8B	3/8" 12 PTS Standard Socket 16mm	29	22.1	19	0.039	15
STMT72906-8B	3/8" 12 PTS Standard Socket 17mm	29	23.3	19	0.04	14
STMT72907-8B	3/8" 12 PTS Standard Socket 18mm	29	24.2	20	0.046	14
STMT72908-8B	3/8" 12 PTS Standard Socket 19mm	29	25.5	21	0.05	11
STMT72909-8B	3/8" 12 PTS Standard Socket 20mm	29	26.8	22	0.048	10
STMT72910-8B	3/8" 12 PTS Standard Socket 21mm	29	27.7	23	0.052	9
STMT72911-8B	3/8" 12 PTS Standard Socket 22mm	29	29.5	24	0.074	8
STMT72912-8B	3/8" 12 PTS Standard Socket 23mm	29	30.7	25	0.082	8
STMT72913-8B	3/8" 12 PTS Standard Socket 24mm	29	31	26	0.082	7

3/8" 6PTS DEEP SOCKET

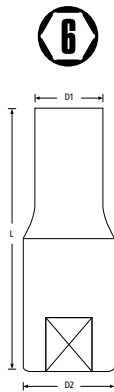

- ASME B107.5M, ISO 1174-1, ISO 1711-1, ISO 691
- Maxi-Drive™ system helps reduce fastener rounding
- Chrome vanadium steel
- For manual use



SKU #	Description	L (mm)	D1 (mm)	D2 (mm)	Weight (kg)	Box Qty
STMT73261-8B	3/8" 6 PTS Deep Socket 8mm	45.5	16.5	12	0.032	9
STMT73262-8B	3/8" 6 PTS Deep Socket 9mm	45.5	16.5	13.1	0.034	9
STMT73263-8B	3/8" 6 PTS Deep Socket 10mm	45.5	16.5	14.7	0.036	9
STMT73264-8B	3/8" 6 PTS Deep Socket 11mm	45.5	16.5	16	0.04	8
STMT73265-8B	3/8" 6 PTS Deep Socket 12mm	45.5	17.1	-	0.040	8
STMT73266-8B	3/8" 6 PTS Deep Socket 13mm	45.5	18.5	-	0.05	8
STMT73267-8B	3/8" 6 PTS Deep Socket 14mm	50	19.5	-	0.062	11
STMT73268-8B	3/8" 6 PTS Deep Socket 15mm	53	20.4	-	0.07	18
STMT73269-8B	3/8" 6 PTS Deep Socket 16mm	53	22	-	0.085	15
STMT73270-8B	3/8" 6 PTS Deep Socket 17mm	56	23.3	-	0.1	15
STMT73271-8B	3/8" 6 PTS Deep Socket 18mm	56	24.2	-	0.112	14
STMT73272-8B	3/8" 6 PTS Deep Socket 19mm	56	25.5	-	0.128	11
STMT73273-8B	3/8" 6 PTS Deep Socket 20mm	63.5	26.8	-	0.111	4
STMT73274-8B	3/8" 6 PTS Deep Socket 21mm	63.5	27.7	-	0.12	4
STMT73275-8B	3/8" 6 PTS Deep Socket 22mm	63.5	29.8	-	0.14	4

3/8" 12PTS DEEP SOCKET

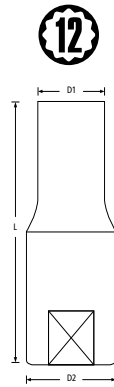

- ASME B107.5M, ISO 1174-1, ISO 1711-1, ISO 691
- Maxi-Drive™ system helps reduce fastener rounding
- Chrome vanadium steel
- For manual use



SKU #	Description	L (mm)	D1 (mm)	D2 (mm)	Weight (kg)	Box Qty
STMT73276-8B	3/8" 12 PTS Deep Socket 8mm	45.5	16.5	12	0.032	9
STMT73277-8B	3/8" 12 PTS Deep Socket 9mm	45.5	16.5	13.1	0.034	9
STMT73278-8B	3/8" 12 PTS Deep Socket 10mm	45.5	16.5	14.7	0.036	9
STMT73279-8B	3/8" 12 PTS Deep Socket 11mm	45.5	16.5	16	0.04	8
STMT73280-8B	3/8" 12 PTS Deep Socket 12mm	45.5	17.1	-	0.041	8
STMT73281-8B	3/8" 12 PTS Deep Socket 13mm	45.5	18.5	-	0.05	8
STMT73282-8B	3/8" 12 PTS Deep Socket 14mm	50	19.5	-	0.062	11
STMT73283-8B	3/8" 12 PTS Deep Socket 15mm	53	20.4	-	0.07	18
STMT73284-8B	3/8" 12 PTS Deep Socket 16mm	53	22	-	0.084	15
STMT73285-8B	3/8" 12 PTS Deep Socket 17mm	56	23.3	-	0.1	15
STMT73286-8B	3/8" 12 PTS Deep Socket 18mm	56	24.2	-	0.112	14
STMT73287-8B	3/8" 12 PTS Deep Socket 19mm	56	25.5	-	0.127	11
STMT73288-8B	3/8" 12 PTS Deep Socket 20mm	63.5	26.8	-	0.111	4
STMT73289-8B	3/8" 12 PTS Deep Socket 21mm	63.5	27.7	-	0.12	4
STMT73290-8B	3/8" 12 PTS Deep Socket 22mm	63.5	29.8	-	0.14	4

3/8" TORX SOCKET

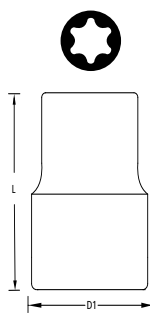

- ISO 1174-1
- For male Torx® screws
- Chrome vanadium steel



SKU #	Description	L (mm)	D1 (mm)	Weight (kg)	Box Qty
STMT73291-8B	3/8" Torx Socket E10	31	17.3	0.0267	12
STMT73292-8B	3/8" Torx Socket E12	31	17.3	0.027	12
STMT73293-8B	3/8" Torx Socket E14	31	17.3	0.0285	12
STMT73294-8B	3/8" Torx Socket E16	31	18.5	0.0336	12

3/8" HEXAGON BIT SOCKET

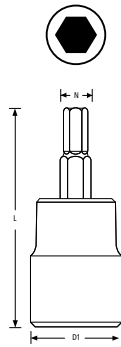

- ISO 1173, ISO 2380-1, ISO 2351-1, ISO 1174-1, ISO 691
- S2 Steel bit
- HRC 60+/-2, 20% higher torque vs Cr-V
- For manual use



SKU #	Description	L (mm)	D1 (mm)	N (mm)	Weight (kg)	Box Qty
STMT73295-8B	3/8" Hexagon Bit Socket 4mm	50	17.9	4	0.038	8
STMT73296-8B	3/8" Hexagon Bit Socket 5mm	50	17.9	5	0.038	8
STMT73297-8B	3/8" Hexagon Bit Socket 6mm	50	17.9	6	0.04	8
STMT73298-8B	3/8" Hexagon Bit Socket 7mm	50	17.9	7	0.04	8
STMT73299-8B	3/8" Hexagon Bit Socket 8mm	50	17.9	8	0.04	8
STMT73300-8B	3/8" Hexagon Bit Socket 10mm	50	17.9	10	0.05	8
STMT73301-8B	3/8" Hexagon Bit Socket 12mm	50	22	12	0.042	8

3/8" TORX BIT SOCKET

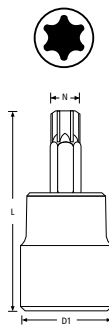

- ISO 1173, ISO 2380-1, ISO 2351-1, ISO 1174-1, ISO 691
- S2 Steel bit
- HRC 60 +/- 2, 20% higher torque vs Cr-V
- For manual use



SKU #	Description	L (mm)	D1 (mm)	N (mm)	Weight (kg)	Box Qty
STMT73313-8B	3/8" Torx Bit Socket T8	50	17.9	T8	0.038	8
STMT73314-8B	3/8" Torx Bit Socket T10	50	17.9	T10	0.038	8
STMT73315-8B	3/8" Torx Bit Socket T15	50	17.9	T15	0.04	8
STMT73316-8B	3/8" Torx Bit Socket T20	50	17.9	T20	0.04	8
STMT73317-8B	3/8" Torx Bit Socket T25	50	17.9	T25	0.05	8
STMT73318-8B	3/8" Torx Bit Socket T27	50	17.9	T27	0.05	8
STMT73319-8B	3/8" Torx Bit Socket T30	50	17.9	T30	0.05	8
STMT73320-8B	3/8" Torx Bit Socket T40	50	17.9	T40	0.045	8
STMT73321-8B	3/8" Torx Bit Socket T45	50	17.9	T45	0.045	8
STMT73322-8B	3/8" Torx Bit Socket T50	50	17.9	T50	0.045	8
STMT73323-8B	3/8" Torx Bit Socket T55	50	17.9	T55	0.06	8

3/8" PHILLIPS BIT SOCKET

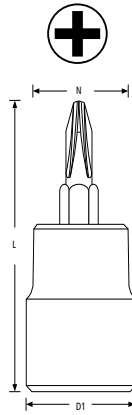

- ISO 1173, ISO 2380-1, ISO 2351-1, ISO 1174-1, ISO 691
- S2 Steel bit
- HRC 60 +/- 2, 20% higher torque vs Cr-V
- For manual use



SKU #	Description	L (mm)	D1 (mm)	N (mm)	Weight (kg)	Box Qty
STMT73305-8B	3/8" Phillips Bit Socket PH1	50	17.9	PH1	0.038	8
STMT73306-8B	3/8" Phillips Bit Socket PH2	50	17.9	PH2	0.038	8
STMT73307-8B	3/8" Phillips Bit Socket PH3	50	17.9	PH3	0.04	8
STMT73308-8B	3/8" Phillips Bit Socket PH4	50	17.9	PH4	0.04	8

3/8" SLOTTED BIT SOCKET

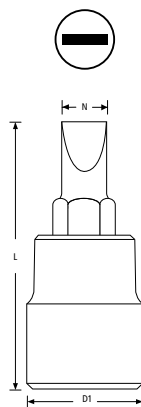

- ISO 1173, ISO 2380-1, ISO 2351-1, ISO 1174-1, ISO 691
- S2 Steel bit
- HRC 60 +/- 2, 20% higher torque vs Cr-V
- For manual use



SKU #	Description	L (mm)	D1 (mm)	N (mm)	Weight (kg)	Box Qty
STMT73302-8B	3/8" Slotted Bit Socket 5.5mm	50	17.9	5.5	0.038	8
STMT73303-8B	3/8" Slotted Bit Socket 7mm	50	17.9	7	0.04	8
STMT73304-8B	3/8" Slotted Bit Socket 8mm	50	17.9	8	0.04	8

3/8" POZIDRIV BIT SOCKET

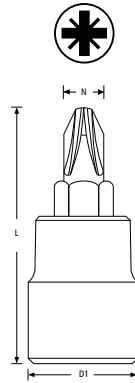

- ISO 1173, ISO 2380-1, ISO 2351-1, ISO 1174-1, ISO 691
- S2 Steel bit
- HRC 60 +/- 2, 20% higher torque vs Cr-V
- For manual use



SKU #	Description	L (mm)	D1 (mm)	N (mm)	Weight (kg)	Box Qty
STMT73309-8B	3/8" Pozidriv Bit Socket PZ1	50	17.9	PZ1	0.038	8
STMT73310-8B	3/8" Pozidriv Bit Socket PZ2	50	17.9	PZ2	0.04	8
STMT73311-8B	3/8" Pozidriv Bit Socket PZ3	50	17.9	PZ3	0.04	8
STMT73312-8B	3/8" Pozidriv Bit Socket PZ4	50	17.9	PZ4	0.04	8



“ THE NP9 RATCHET IS THE STAR PRODUCT IN MY TOOL BOX. ITS 60 TEETH MECHANISM IS JUST RIGHT AS IT IS NOT TOO MUCH AND NOT TOO LITTLE. IT OFFERS THE PERFECT COMBINATION OF DURABILITY AND PRECISION TO ENSURE THAT I GET THE JOB DONE EVERY TIME. ”

1/2" SOCKET SET - 24 PCS

NEW



- 1/2" 6PTS Standard socket 10, 11, 12, 13, 14, 15, 16, 17, 18, 19, 20, 21, 22, 23, 24, 27, 30, 32
- 1/2" Pear head ratchet P9
- 1/2" Extension 125, 250mm
- 1/2" Sliding tee
- 1/2" Universal joint
- 1/2" 12PTS Spark plug socket 16mm

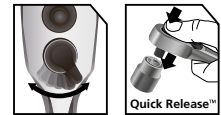

SKU #	Description	L (mm)	W (mm)	H (mm)	Weight (kg)
STMT72795-8	24PCS 1/2" Dr. Socket & Bit Set	200	70	417	4.25

23 PCS 1/2" 6PTS METRIC SOCKET SET

NEW



16" TOOL SET CASE + MODULE :

- 1/2" Pear head ratchet NP9
- 1/2" L-handle 90 degree
- 1/2" Extension 125, 250mm
- 1/2" Universal joint
- 1/2" 6PTS Standard socket 8, 9, 10, 11, 12, 13, 14, 15, 16, 17, 18, 19, 21, 22, 24, 27, 30, 32mm

COMPATIBLE with
TRANS
MODULE
system



SKU #	Description	L (mm)	W (mm)	H (mm)	Weight (kg)	Box Qty
STMT74173-8C	23 PCS 1/2" 6 PTS Metric Socket Set	405	290	60	3.95	1

1/2" METRIC BIT SOCKET MODULE - 24 PCS

NEW
STANLEY
EXCEEDS
DIN/ISO
STANDARD



COMPATIBLE with
**TRANS
MODULE**
system

STANLEY
EXCEEDS
DIN/ISO
STANDARD

- 1/2" Torx bit socket T20, T25, T27, T30, T40, T45, T50, T55, T60
- 1/2" Long torx bit socket T30, T40, T45, T50, T55, T60
- 1/2" Torx socket E10, E11, E12, E14, E16, E18, E20, E22, E24

SKU #	Description	Length (mm)	Width (mm)	Height (mm)	Carton Qty
STMT74176-8	24 PCS 1/2" Metric Bit Socket Module	384	184	45	4

1/2" PEAR HEAD RATCHET NP9

NEW
STANLEY
EXCEEDS
DIN/ISO
STANDARD

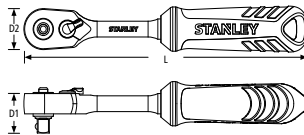

- ASME B107.10M-2005, ISO 3315, DIN 3122, ISO 1174-1
- Socket safety lock
- Lever reverse: rotation direction displayed
- Chrome vanadium steel
- Chemical resistant ergonomic bimaterial handle
- Quick release button

STANLEY
EXCEEDS
DIN/ISO
STANDARD

Retail SKU #	BULK SKU #	Description	L (mm)	D1 (mm)	D2 (mm)	Gear	Increment	Weight (kg)	Retail / BULK Box Qty
STMT73984-8	STMT73984-8B	1/2" Pear Head Ratchet NP9	256.5	32.5	35.7	60	6°	0.425	5 / 5

1/2" PEAR HEAD RATCHET P7

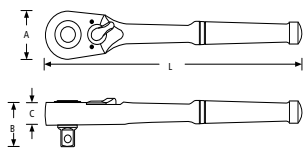

- ASME B107.10M-2005, ISO 3315, DIN 3122, ISO 1174-1
- Socket safety lock
- Lever reverse: rotation direction displayed
- Chrome vanadium steel
- Quick release button

STANLEY
EXCEEDS
ANSI
STANDARD

SKU #	Description	L (mm)	D1 (mm)	D2 (mm)	Gear	Increment	Weight (kg)	Box Qty
STMT89819-8B	1/2" Pear Head Ratchet P7	240	41	40	54	6.7°	0.588	6

1/2" ROUND HEAD RATCHET

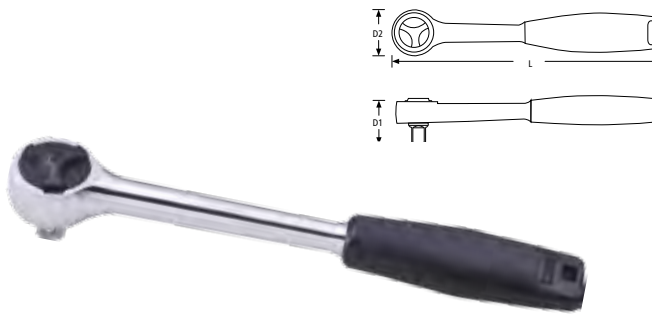

- ASME B107.10M-2005, ISO 3315, DIN 3122, ISO 1174-1
- Socket safety lock
- Chrome vanadium steel
- Quick release button



SKU #	Description	L (mm)	D1 (mm)	D2 (mm)	Gear	Increment	Weight (kg)	Box Qty
STMT86397-8B	1/2" Round Head Ratchet	265	42	46	45	8°	0.596	4

1/2" SLIDING TEE

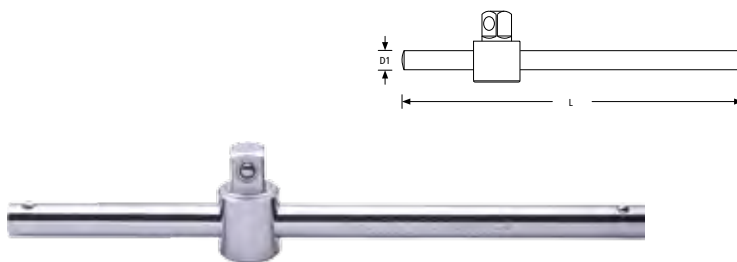

- ASME B107.10M, ISO 3315 - DIN 3122 - ISO 1174-1
- Sliding head
- Chrome vanadium steel
- For manual use



SKU #	Description	L (mm)	D1 (mm)	Weight (kg)	Box Qty
STMT86410-8B	1/2" Sliding Tee	241	12.7	0.41	4

1/2" EXTENSION

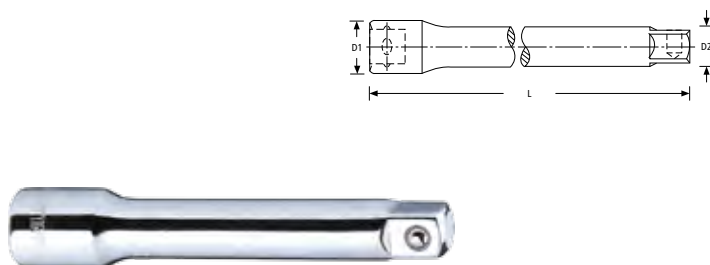

- ASME B107.10M, ISO 3316 - DIN 3123 - ISO 1174-1
- Full polished finishing
- Chrome vanadium steel
- For manual use



SKU #	Description	L (mm)	D1 (mm)	D2 (mm)	Weight (kg)	Box Qty
STMT88930-8B	1/2" Extension 75mm	76.2	22.5	16.3	0.123	5
STMT86407-8B	1/2" Extension 125mm	125	22.5	16.3	0.22	6
STMT86408-8B	1/2" Extension 250mm	252	22.5	16.3	0.42	12

1/2" COUPLER

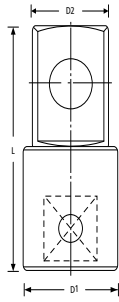

- ASME B107.10M, ISO 1174-1, ISO 691
- Chrome vanadium steel
- For manual use



SKU #	Description	L (mm)	D1 (mm)	D2 (mm)	Weight (kg)	Box Qty
STMT86414-8B	1/2" F x 3/8" M	34.5	22	10	0.046	15
STMT88558-8B	1/2" F x 3/4" M	42	25.2	19	0.111	12

1/2" UNIVERSAL JOINT

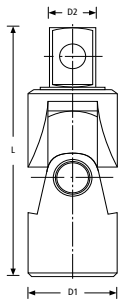

- ASME B107.10M, ISO 1174-2
- Chrome vanadium steel
- For manual use



SKU #	Description	L (mm)	D1 (mm)	D2 (mm)	Weight (kg)	Box Qty
STMT86411-8B	1/2" Universal Joint	68.5	24.9	12.5	0.1426	10

1/2" SPEED HANDLE

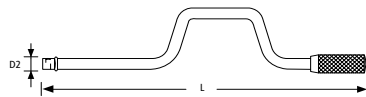

- ASME B107.10M, ISO 3315 - DIN 3122 - ISO 1174-1
- Fast rotation
- Rotating handle
- Knurled handle



SKU #	Description	L (mm)	D2 (mm)	Weight (kg)	Box Qty
STMT86412-8B	1/2" Speed Handle	420	21	0.554	4

1/2" SWIVEL HANDLE

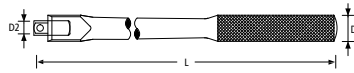

- ASME B107.10M, ISO 3315 - DIN 3122 - ISO 1174-1
- Smooth-action joint
- Hinged handle for easier access
- Knurl surface handle design to anti-slip



SKU #	Description	L (mm)	D1 (mm)	D2 (mm)	Weight (kg)	Box Qty
STMT86405-8B	1/2" 250mm Swivel Handle	254	28	21	0.5338	4

1/2" L-HANDLE

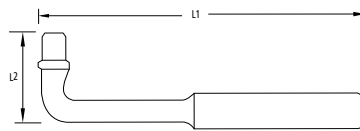

- ASME B107.10M, ISO 1174-1, ISO 691 SO 1174-1, ISO 691
- Chrome vanadium steel
- Knurled handle



SKU #	Description	L1 (mm)	L2 (mm)	Weight (kg)	Box Qty
STMT86493-8B	1/2" L-Handle 90 degree	250	50	0.304	4

1/2" 12PTS SPARK PLUG SOCKET

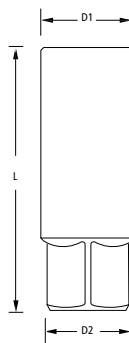

- ASME B107.34M
- Chrome vanadium steel
- For manual use



SKU #	Description	L (mm)	D1 (mm)	D2 (mm)	Weight (kg)	Box Qty
STMT88996-8B	1/2" 12 PTS Spark Plug Socket 21mm	70	27	12.5	0.146	4

1/2" 6PTS STANDARD SOCKET

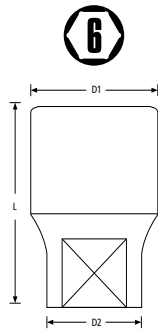

- ASME B107.5M, DIN 3124, ISO 1174-1, ISO 1711-1, ISO 691
- Maxi-Drive™ system helps reduce fastener rounding
- Chrome vanadium steel
- For manual use



SKU #	Description	L (mm)	D1 (mm)	D2 (mm)	Weight (kg)	Box Qty
STMT72933-8B	1/2" 6 PTS Standard Socket 8mm	38	21.8	12.4	0.045	15
STMT72934-8B	1/2" 6 PTS Standard Socket 9mm	38	21.8	14	0.048	15
STMT72935-8B	1/2" 6 PTS Standard Socket 10mm	38	21.8	15.5	0.048	15
STMT72936-8B	1/2" 6 PTS Standard Socket 11mm	38	21.8	16.7	0.05	15
STMT72937-8B	1/2" 6 PTS Standard Socket 12mm	38	21.8	18	0.053	15
STMT72938-8B	1/2" 6 PTS Standard Socket 13mm	38	21.8	19.2	0.052	15
STMT72939-8B	1/2" 6 PTS Standard Socket 14mm	38	21.8	20.5	0.056	15
STMT72940-8B	1/2" 6 PTS Standard Socket 15mm	38	21.8	21	0.054	15
STMT72941-8B	1/2" 6 PTS Standard Socket 16mm	38	23.3	22.5	0.064	14
STMT72942-8B	1/2" 6 PTS Standard Socket 17mm	38	24	23	0.07	12
STMT72943-8B	1/2" 6 PTS Standard Socket 18mm	38	24.8	23	0.07	12
STMT72944-8B	1/2" 6 PTS Standard Socket 19mm	38	26.3	24	0.074	9
STMT72945-8B	1/2" 6 PTS Standard Socket 20mm	38	26.8	24	0.066	9
STMT72946-8B	1/2" 6 PTS Standard Socket 21mm	38	27.7	24	0.084	9
STMT72947-8B	1/2" 6 PTS Standard Socket 22mm	40	29.8	26	0.098	4
STMT72948-8B	1/2" 6 PTS Standard Socket 23mm	40	30.8	26	0.098	4
STMT72949-8B	1/2" 6 PTS Standard Socket 24mm	40	31.8	26	0.1	4
STMT72950-8B	1/2" 6 PTS Standard Socket 25mm	40	32.8	27	0.115	2
STMT72951-8B	1/2" 6 PTS Standard Socket 26mm	43	33.8	28.8	0.11	2
STMT72952-8B	1/2" 6 PTS Standard Socket 27mm	43	35.8	29.5	0.136	2
STMT72953-8B	1/2" 6 PTS Standard Socket 28mm	43	37.6	30.5	0.142	2
STMT72954-8B	1/2" 6 PTS Standard Socket 29mm	43	37.8	31.5	0.145	2
STMT72955-8B	1/2" 6 PTS Standard Socket 30mm	43	39.8	32.5	0.184	2
STMT72956-8B	1/2" 6 PTS Standard Socket 32mm	43	41.8	34.5	0.23	2
STMT72957-8B	1/2" 6 PTS Standard Socket 34mm	45.5	43.8	36.5	0.3	3
STMT72958-8B	1/2" 6 PTS Standard Socket 36mm	57.2	49.8	38	0.45	2

1/2" 12PTS STANDARD SOCKET

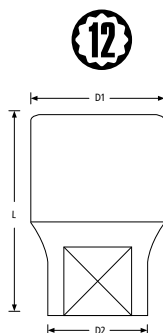

- ASME B107.5M, DIN 3124, ISO 1174-1, ISO 1711-1, ISO 691
- Maxi-Drive™ system helps reduce fastener rounding
- Chrome vanadium steel
- For manual use



SKU #	Description	L (mm)	D1 (mm)	D2 (mm)	Weight (kg)	Box Qty
STMT72959-8B	1/2" 12 PTS Standard Socket 8mm	38	21.8	12.4	0.044	15
STMT72960-8B	1/2" 12 PTS Standard Socket 9mm	38	21.8	14	0.048	15
STMT72961-8B	1/2" 12 PTS Standard Socket 10mm	38	21.8	15.5	0.048	15
STMT72962-8B	1/2" 12 PTS Standard Socket 11mm	38	21.8	16.7	0.05	15
STMT72963-8B	1/2" 12 PTS Standard Socket 12mm	38	21.8	18	0.052	15
STMT72964-8B	1/2" 12 PTS Standard Socket 13mm	38	21.8	19.2	0.052	15
STMT72965-8B	1/2" 12 PTS Standard Socket 14mm	38	21.8	20.5	0.056	15
STMT72966-8B	1/2" 12 PTS Standard Socket 15mm	38	21.8	21	0.054	15
STMT72967-8B	1/2" 12 PTS Standard Socket 16mm	38	23.3	22.5	0.064	14
STMT72968-8B	1/2" 12 PTS Standard Socket 17mm	38	24	23	0.065	12
STMT72969-8B	1/2" 12 PTS Standard Socket 18mm	38	24.8	23	0.07	12
STMT72970-8B	1/2" 12 PTS Standard Socket 19mm	38	26.3	24	0.074	9
STMT72971-8B	1/2" 12 PTS Standard Socket 20mm	38	26.8	24	0.066	9
STMT72972-8B	1/2" 12 PTS Standard Socket 21mm	38	27.7	24	0.068	9
STMT72973-8B	1/2" 12 PTS Standard Socket 22mm	40	29.8	26	0.096	4
STMT72974-8B	1/2" 12 PTS Standard Socket 23mm	40	30.8	26	0.096	4
STMT72975-8B	1/2" 12 PTS Standard Socket 24mm	40	31.8	26	0.100	4
STMT72976-8B	1/2" 12 PTS Standard Socket 25mm	40	32.8	27	0.11	2
STMT72977-8B	1/2" 12 PTS Standard Socket 26mm	43	33.8	28.8	0.120	2
STMT72978-8B	1/2" 12 PTS Standard Socket 27mm	43	35.8	29.5	0.126	2
STMT72979-8B	1/2" 12 PTS Standard Socket 28mm	43	37.6	30.5	0.138	2
STMT72980-8B	1/2" 12 PTS Standard Socket 29mm	43	37.8	31.5	0.14	2
STMT72981-8B	1/2" 12 PTS Standard Socket 30mm	43	39.8	32.5	0.164	2
STMT72982-8B	1/2" 12 PTS Standard Socket 32mm	43	41.8	34.5	0.22	2
STMT72983-8B	1/2" 12 PTS Standard Socket 34mm	45.5	43.8	36.5	0.3	3
STMT72984-8B	1/2" 12 PTS Standard Socket 36mm	57.2	49.8	38	0.45	2

1/2" 6PTS DEEP SOCKET

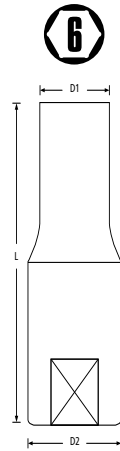

- ASME B107.5M, ISO 1174-1, ISO 1711-1, ISO 691
- Maxi-Drive™ system helps reduce fastener rounding
- Chrome vanadium steel
- For manual use



SKU #	Description	L (mm)	D1 (mm)	D2 (mm)	Weight (kg)	Box Qty
STMT73324-8B	1/2" 6 PTS Deep Socket 10mm	79	22	15.5	0.125	8
STMT73325-8B	1/2" 6 PTS Deep Socket 11mm	79	22	16.7	0.13	8
STMT73326-8B	1/2" 6 PTS Deep Socket 12mm	79	22	18	0.113	8
STMT73327-8B	1/2" 6 PTS Deep Socket 13mm	79	22	19.2	0.12	8
STMT73328-8B	1/2" 6 PTS Deep Socket 14mm	79	22	20.5	0.12	8
STMT73329-8B	1/2" 6 PTS Deep Socket 15mm	79	22	21	0.115	8
STMT73330-8B	1/2" 6 PTS Deep Socket 16mm	79	23.3	22.5	0.131	6
STMT73331-8B	1/2" 6 PTS Deep Socket 17mm	79	24	-	0.155	6
STMT73332-8B	1/2" 6 PTS Deep Socket 18mm	79	25.3	-	0.165	6
STMT73333-8B	1/2" 6 PTS Deep Socket 19mm	79	26.5	-	0.186	4
STMT73334-8B	1/2" 6 PTS Deep Socket 21mm	79	27.8	-	0.19	6
STMT73335-8B	1/2" 6 PTS Deep Socket 22mm	79	27.8	-	0.222	5
STMT73336-8B	1/2" 6 PTS Deep Socket 23mm	79	30.8	-	0.25	5
STMT73337-8B	1/2" 6 PTS Deep Socket 24mm	79	31.8	-	0.255	5
STMT73338-8B	1/2" 6 PTS Deep Socket 27mm	79	35.8	-	0.325	4
STMT73339-8B	1/2" 6 PTS Deep Socket 30mm	79	39.8	-	0.45	2
STMT73340-8B	1/2" 6 PTS Deep Socket 32mm	79	41.3	-	0.52	2



“ WHEN A CAR COMES IN WITH A LOT OF DAMAGED FASTENERS WE KNOW THAT THE PREVIOUS GUY WAS NOT USING STANLEY SOCKETS AND ITS MAXI-DRIVE PROFILE. IT'S VERY IMPORTANT FOR US NOT TO DAMAGE NUTS WHEN WE DO THE JOB; WE KNOW THE CAR WILL COME BACK ONE DAY THAT'S WHEN PROBLEMS ARISE. ”

1/2" 12PTS DEEP SOCKET

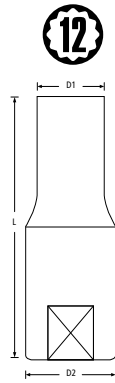

- ASME B107.5M, ISO 1174-1, ISO 1711-1, ISO 691
- Maxi-Drive™ system helps reduce fastener rounding
- Chrome vanadium steel
- For manual use



SKU #	Description	L (mm)	D1 (mm)	D2 (mm)	Weight (kg)	Box Qty
STMT73341-8B	1/2" 12 PTS Deep Socket 10mm	79	22	15.5	0.125	8
STMT73342-8B	1/2" 12 PTS Deep Socket 11mm	79	22	16.7	0.13	8
STMT73343-8B	1/2" 12 PTS Deep Socket 12mm	79	22	18	0.109	8
STMT73344-8B	1/2" 12 PTS Deep Socket 13mm	79	22	19.2	0.114	8
STMT73345-8B	1/2" 12 PTS Deep Socket 14mm	79	22	20.5	0.117	8
STMT73346-8B	1/2" 12 PTS Deep Socket 15mm	79	22	21	0.113	8
STMT73347-8B	1/2" 12 PTS Deep Socket 16mm	79	23.3	22.5	0.127	6
STMT73348-8B	1/2" 12 PTS Deep Socket 17mm	79	24	-	0.155	6
STMT73349-8B	1/2" 12 PTS Deep Socket 18mm	79	25.3	-	0.165	6
STMT73350-8B	1/2" 12 PTS Deep Socket 19mm	79	26.5	-	0.179	4
STMT73351-8B	1/2" 12 PTS Deep Socket 20mm	79	27.8	-	0.195	6
STMT73352-8B	1/2" 12 PTS Deep Socket 21mm	79	27.8	-	0.187	6
STMT73353-8B	1/2" 12 PTS Deep Socket 22mm	79	27.8	-	0.215	5
STMT73354-8B	1/2" 12 PTS Deep Socket 23mm	79	30.8	-	0.25	5
STMT73355-8B	1/2" 12 PTS Deep Socket 24mm	79	31.8	-	0.245	5
STMT73356-8B	1/2" 12 PTS Deep Socket 25mm	79	32.8	-	0.3	4
STMT73357-8B	1/2" 12 PTS Deep Socket 26mm	79	33.8	-	0.3	4
STMT73358-8B	1/2" 12 PTS Deep Socket 27mm	79	35.8	-	0.315	4
STMT73359-8B	1/2" 12 PTS Deep Socket 28mm	79	37.6	-	0.45	2
STMT73360-8B	1/2" 12 PTS Deep Socket 30mm	79	39.8	-	0.48	2
STMT73361-8B	1/2" 12 PTS Deep Socket 32mm	79	41.3	-	0.5	2



“ I HAVE BEEN A STANLEY USER FOR YEARS BECAUSE THE WAY I SEE IT, THERE IS NO NEED TO IMPROVE ON EXCELLENCE. ”

1/2" HEXAGON BIT SOCKET

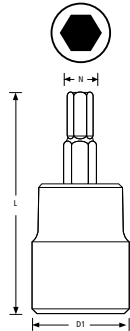

- ISO 1173, ISO 2380-1, ISO 2351-1, ISO 1174-1, ISO 691
- S2 Steel bit
- HRC 60 +/- 2, 20% higher torque vs Cr-V
- For manual use



SKU #	Description	L (mm)	D1 (mm)	N (mm)	Weight (kg)	Box Qty
STMT73371-8B	1/2" Hexagonal Bit Socket 4mm	55	22	4	0.06	6
STMT73372-8B	1/2" Hexagonal Bit Socket 5mm	55	22	5	0.06	6
STMT73373-8B	1/2" Hexagonal Bit Socket 6mm	55	22	6	0.06	6
STMT73374-8B	1/2" Hexagonal Bit Socket 7mm	55	22	7	0.06	6
STMT73375-8B	1/2" Hexagonal Bit Socket 8mm	55	22	8	0.065	6
STMT73376-8B	1/2" Hexagonal Bit Socket 9mm	55	22	9	0.075	6
STMT73377-8B	1/2" Hexagonal Bit Socket 10mm	55	22	10	0.08	6
STMT73378-8B	1/2" Hexagonal Bit Socket 12mm	55	22	12	0.085	6
STMT73379-8B	1/2" Hexagonal Bit Socket 14mm	55	22	14	0.098	6
STMT73380-8B	1/2" Hexagonal Bit Socket 17mm	55	25	17	0.14	3
STMT73381-8B	1/2" Hexagonal Bit Socket 19mm	60	27.9	19	0.16	2

1/2" LONG HEX BIT SOCKET

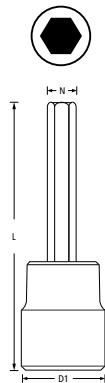

- ISO 1173, ISO 2380-1, ISO 2351-1, ISO 1174-1, ISO 691
- S2 Steel Bit
- HRC 60 +/- 2, 20% higher torque vs Cr-V
- For manual use



SKU #	Description	L (mm)	D1 (mm)	N (mm)	Weight (kg)	Box Qty
STMT73382-8B	1/2" Long Hex Bit Socket 4mm	100	22	4	0.07	6
STMT73383-8B	1/2" Long Hex Bit Socket 5mm	100	22	5	0.07	6
STMT73384-8B	1/2" Long Hex Bit Socket 6mm	100	22	6	0.07	6
STMT73385-8B	1/2" Long Hex Bit Socket 7mm	100	22	7	0.07	6
STMT73386-8B	1/2" Long Hex Bit Socket 8mm	100	22	8	0.09	6
STMT73387-8B	1/2" Long Hex Bit Socket 10mm	100	22	10	0.1	6
STMT73388-8B	1/2" Long Hex Bit Socket 12mm	100	22	12	0.11	6

1/2" TORX BIT SOCKET

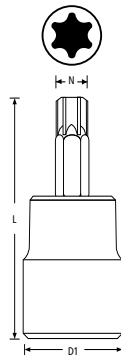

- ISO 1173, ISO 2380-1, ISO 2351-1, ISO 1174-1, ISO 691
- S2 Steel bit
- HRC 60 +/- 2, 20% higher torque vs Cr-V
- For manual use



SKU #	Description	L (mm)	D1 (mm)	N (mm)	Weight (kg)	Box Qty
STMT73389-8B	1/2" Torx Bit Socket T20	55	22	T20	0.052	6
STMT73390-8B	1/2" Torx Bit Socket T25	55	22	T25	0.052	6
STMT73391-8B	1/2" Torx Bit Socket T27	55	22	T27	0.052	6
STMT73392-8B	1/2" Torx Bit Socket T30	55	22	T30	0.052	6
STMT73393-8B	1/2" Torx Bit Socket T40	55	22	T40	0.052	6
STMT73394-8B	1/2" Torx Bit Socket T45	55	22	T45	0.060	6
STMT73395-8B	1/2" Torx Bit Socket T50	55	22	T50	0.062	6
STMT73396-8B	1/2" Torx Bit Socket T55	55	22	T55	0.072	6
STMT73397-8B	1/2" Torx Bit Socket T60	55	22	T60	0.075	6

1/2" LONG TORX BIT SOCKET



- ISO 1173, ISO 2380-1, ISO 2351-1, ISO 1174-1, ISO 691
- S2 Steel bit
- HRC 60 +/- 2, 20% higher torque vs Cr-V
- For manual use



SKU #	Description	L (mm)	D1 (mm)	N (mm)	Weight (kg)	Box Qty
STMT73398-8B	1/2" Long Torx Bit Socket T30	100	22	T30	0.08	6
STMT73399-8B	1/2" Long Torx Bit Socket T40	100	22	T40	0.08	6
STMT73400-8B	1/2" Long Torx Bit Socket T45	100	22	T45	0.085	6
STMT73401-8B	1/2" Long Torx Bit Socket T50	100	22	T50	0.09	6
STMT73402-8B	1/2" Long Torx Bit Socket T55	100	22	T55	0.102	6
STMT73403-8B	1/2" Long Torx Bit Socket T60	100	22	T60	0.122	6

1/2" TAMPERTORX BIT SOCKET

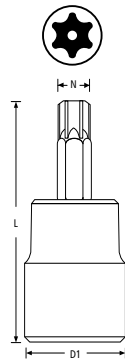

- ISO 1173, ISO 2380-1, ISO 2351-1, ISO 1174-1, ISO 691
- S2 Steel bit
- HRC 60 +/- 2, 20% higher torque vs Cr-V
- For manual use



SKU #	Description	L (mm)	D1 (mm)	N (mm)	Weight (kg)	Box Qty
STMT73404-8B	1/2" TamperTorx Bit Socket TT10	55	22	TT10	0.07	6
STMT73405-8B	1/2" TamperTorx Bit Socket TT15	55	22	TT15	0.07	6
STMT73406-8B	1/2" TamperTorx Bit Socket TT20	55	22	TT20	0.07	6
STMT73407-8B	1/2" TamperTorx Bit Socket TT25	55	22	TT25	0.07	6
STMT73408-8B	1/2" TamperTorx Bit Socket TT27	55	22	TT27	0.07	6
STMT73409-8B	1/2" TamperTorx Bit Socket TT30	55	22	TT30	0.07	6
STMT73410-8B	1/2" TamperTorx Bit Socket TT40	55	22	TT40	0.07	6
STMT73411-8B	1/2" TamperTorx Bit Socket TT45	55	22	TT45	0.07	6
STMT73412-8B	1/2" TamperTorx Bit Socket TT50	55	22	TT50	0.07	6
STMT73413-8B	1/2" TamperTorx Bit Socket TT55	55	22	TT55	0.07	6
STMT73414-8B	1/2" TamperTorx Bit Socket TT60	55	22	TT60	0.082	6

1/2" SPLINE BIT SOCKET

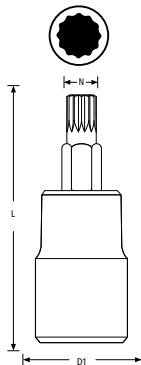

- ISO 1173, ISO 2380-1, ISO 2351-1, ISO 1174-1, ISO 691
- S2 Steel bit
- HRC 60 +/- 2, 20% higher torque vs Cr-V
- For manual use



SKU #	Description	L (mm)	D1 (mm)	N (mm)	Weight (kg)	Box Qty
STMT73415-8B	1/2" Spline Bit Socket M5	55	22	M5	0.07	6
STMT73416-8B	1/2" Spline Bit Socket M6	55	22	M6	0.07	6
STMT73417-8B	1/2" Spline Bit Socket M8	55	22	M8	0.07	6
STMT73418-8B	1/2" Spline Bit Socket M10	55	22	M10	0.072	6
STMT73419-8B	1/2" Spline Bit Socket M12	55	22	M12	0.072	6
STMT73420-8B	1/2" Spline Bit Socket M14	55	22	M14	0.072	6
STMT73421-8B	1/2" Spline Bit Socket M16	55	25	M16	0.14	6

1/2" LONG SPLINE BIT SOCKET

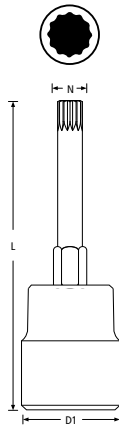

- ISO 1173, ISO 2380-1, ISO 2351-1, ISO 1174-1, ISO 691
- S2 Steel Bit
- HRC 60 +/- 2, 20% higher torque vs Cr-V
- For manual use



SKU #	Description	L (mm)	D1 (mm)	N (mm)	Weight (kg)	Box Qty
STMT73422-8B	1/2" Long Spline Bit Socket M5	100	22	M5	0.116	6
STMT73423-8B	1/2" Long Spline Bit Socket M6	100	22	M6	0.116	6
STMT73424-8B	1/2" Long Spline Bit Socket M8	100	22	M8	0.116	6
STMT73425-8B	1/2" Long Spline Bit Socket M10	100	22	M10	0.12	6
STMT73426-8B	1/2" Long Spline Bit Socket M12	100	22	M12	0.13	6
STMT73427-8B	1/2" Long Spline Bit Socket M14	100	22	M14	0.16	6
STMT73428-8B	1/2" Long Spline Bit Socket M16	100	25	M16	0.218	6

1/2" TORX SOCKET

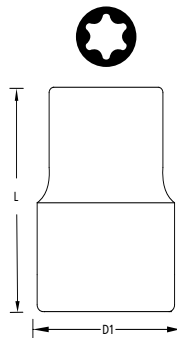

- ISO 1174-1
- For male Torx® screws
- Chrome vanadium steel



SKU #	Description	L (mm)	D1 (mm)	Weight (kg)	Box Qty
STMT73362-8B	1/2" Torx Socket E10	40	22	0.05	15
STMT73363-8B	1/2" Torx Socket E11	40	22	0.05	15
STMT73364-8B	1/2" Torx Socket E12	40	22	0.052	15
STMT73365-8B	1/2" Torx Socket E14	40	22	0.052	15
STMT73366-8B	1/2" Torx Socket E16	40	22	0.056	15
STMT73367-8B	1/2" Torx Socket E18	40	22	0.056	15
STMT73368-8B	1/2" Torx Socket E20	40	23.5	0.058	15
STMT73369-8B	1/2" Torx Socket E22	40	25	0.09	12
STMT73370-8B	1/2" Torx Socket E24	40	27	0.107	9

3/4" RATCHET

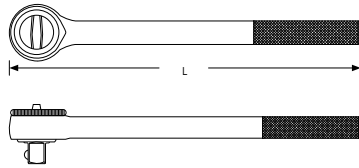

- ASME B107.10M-2005, ISO 3315, DIN 3122, ISO 1174-1
- Chrome vanadium steel
- Knurled handle



SKU #	Description	L (mm)	Gear	Increment	Weight (kg)	Box Qty
STMT91316-8B	3/4" Ratchet With Handle	500	45	8	2.56	2

3/4" SLIDING TEE

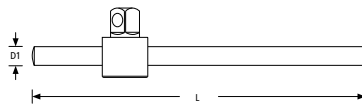

- ASME B107.10M, ISO 3315 - DIN 3122 - ISO 1174-1
- Sliding head
- Chrome vanadium steel
- For manual use



SKU #	Description	L (mm)	D1 (mm)	Weight (kg)	Box Qty
STMT89303-8B	3/4" Sliding Tee	483	20	1.437	2

3/4" EXTENSION

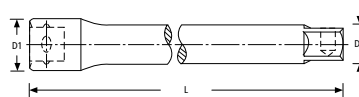

- ASME B107.10M, ISO 3316 - DIN 3123 - ISO 1174-1
- Full polished finishing
- Chrome vanadium steel
- For manual use



SKU #	Description	L (mm)	D1 (mm)	D2 (mm)	Weight (kg)	Box Qty
STMT89306-8B	3/4" Extension 100mm	102	35.5	23	0.44	4
STMT89307-8B	3/4" Extension 200mm	203	35.5	23	0.72	4

3/4" COUPLER

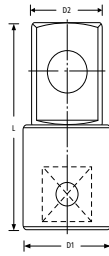

- ASME B107.10M, ISO 1174-1, ISO 691
- Chrome vanadium steel
- For manual use



SKU #	Description	L (mm)	D1 (mm)	D2 (mm)	Weight (kg)	Box Qty
STMT88908-8B	Coupler 3/4" to 1/2"	48	35	12.5	0.125	4
STMT88909-8B	Coupler 3/4" to 1"	62	37.3	25.4	0.16	4

3/4" UNIVERSAL JOINT

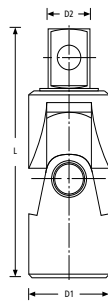

- ASME B107.10M, ISO 1174-2
- Chrome vanadium steel
- For manual use



SKU #	Description	L (mm)	D1 (mm)	D2 (mm)	Weight (kg)	Box Qty
STMT93091-8B	3/4" Universal Joint	110	40	19	0.225	4

3/4" SWIVEL HANDLE



- ASME B107.10M, ISO 3315 - DIN 3122 - ISO 1174-1
- Smooth-action joint
- Hinged handle for easier access
- Knurled handle



SKU #	Description	L (mm)	Weight (kg)	Box Qty
STMT89302-8B	3/4" Swivel Handle	510	1.406	2

3/4" 6PTS STANDARD SOCKET

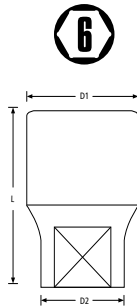

- ASME B107.5M, DIN 3124, ISO 1174-1, ISO 1711-1, ISO 691
- Chrome vanadium steel
- For manual use



SKU #	Description	L (mm)	D1 (mm)	D2 (mm)	Weight (kg)	Box Qty
STMT89319-8B	3/4" 6PTS Socket 19mm	50	36	29.3	0.213	4
STMT89322-8B	3/4" 6PTS Socket 22mm	50	36	31.3	0.217	4
STMT89324-8B	3/4" 6PTS Socket 24mm	51	36	33.3	0.216	4
STMT89325-8B	3/4" 6PTS Socket 25mm	52	36	34.3	0.216	4
STMT89327-8B	3/4" 6PTS Socket 27mm	52	36	36	0.219	4
STMT89328-8B	3/4" 6PTS Socket 28mm	52	38	38	0.254	4
STMT89330-8B	3/4" 6PTS Socket 30mm	54	38	40	0.285	4
STMT89332-8B	3/4" 6PTS Socket 32mm	56	38	42	0.315	4
STMT89333-8B	3/4" 6PTS Socket 33mm	56	38	44	0.329	4
STMT89334-8B	3/4" 6PTS Socket 34mm	56	38	44	0.332	4
STMT89336-8B	3/4" 6PTS Socket 36mm	58	42	50	0.417	4
STMT89338-8B	3/4" 6PTS Socket 38mm	60	45	52	0.479	4
STMT89341-8B	3/4" 6PTS Socket 41mm	64	45	56	0.573	4
STMT89346-8B	3/4" 6PTS Socket 46mm	68	48	62	0.684	4
STMT89350-8B	3/4" 6PTS Socket 50mm	72	48	68	0.852	4



“ FOR GOOD REASON, WE CALL THE 3/4 RANGE THE MAMMOTH OF ALL SOCKETS AS THEY ARE SO HUGE AND STURDY. HOWEVER UNLIKE THE GIANT CREATURES, WE KNOW THAT THIS RANGE WILL PROBABLY NOT GO EXTINCT AS THEY ARE SIMPLE UNBREAKABLE. ”

3/4" 12PTS STANDARD SOCKET

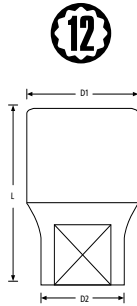

- ASME B107.5M, DIN 3124, ISO 1174-1, ISO 1711-1, ISO 691
- Chrome vanadium steel
- For manual use



SKU #	Description	L (mm)	D1 (mm)	D2 (mm)	Weight (kg)	Box Qty
Metric						
STMT89619-8B	3/4" 12 PTS Socket 19mm	50	36	29.3	0.213	4
STMT89621-8B	3/4" 12 PTS Socket 21mm	50	36	30.3	0.213	4
STMT89622-8B	3/4" 12 PTS Socket 22mm	50	36	31.3	0.217	4
STMT89623-8B	3/4" 12 PTS Socket 23mm	50	36	32.3	0.213	4
STMT89624-8B	3/4" 12 PTS Socket 24mm	51	36	33.3	0.216	4
STMT89625-8B	3/4" 12 PTS Socket 25mm	52	36	34.3	0.216	4
STMT89626-8B	3/4" 12 PTS Socket 26mm	52	36	35	0.216	4
STMT89627-8B	3/4" 12 PTS Socket 27mm	52	36	36	0.219	4
STMT89628-8B	3/4" 12 PTS Socket 28mm	52	38	38	0.254	4
STMT89629-8B	3/4" 12 PTS Socket 29mm	52	38	40	0.253	4
STMT89630-8B	3/4" 12 PTS Socket 30mm	54	38	40	0.285	4
STMT89632-8B	3/4" 12 PTS Socket 32mm	56	38	42	0.315	4
STMT89633-8B	3/4" 12 PTS Socket 33mm	56	38	44	0.329	4
STMT89634-8B	3/4" 12 PTS Socket 34mm	56	38	44	0.332	4
STMT89635-8B	3/4" 12 PTS Socket 35mm	58	42	46	0.379	4
STMT89636-8B	3/4" 12 PTS Socket 36mm	58	42	50	0.417	4
STMT89638-8B	3/4" 12 PTS Socket 38mm	60	45	52	0.479	4
STMT89640-8B	3/4" 12 PTS Socket 40mm	62	45	54	0.573	4
STMT89641-8B	3/4" 12 PTS Socket 41mm	64	45	56	0.573	4
STMT89642-8B	3/4" 12 PTS Socket 42mm	64	45	57	0.572	4
STMT89644-8B	3/4" 12 PTS Socket 44mm	66	48	60	0.587	4
STMT89646-8B	3/4" 12 PTS Socket 46mm	68	48	62	0.684	4
STMT89650-8B	3/4" 12 PTS Socket 50mm	72	48	68	0.852	4
STMT89654-8B	3/4" 12 PTS Socket 54mm	74	48	72	0.953	4
STMT89655-8B	3/4" 12 PTS Socket 55mm	76	48	74	0.994	4
STMT89658-8B	3/4" 12 PTS Socket 58mm	76	52	76	1.12	4
STMT89660-8B	3/4" 12 PTS Socket 60mm	78	54	78	1.28	4

3/4" 12PTS STANDARD SOCKET

- ASME B107.5M, DIN 3124, ISO 1174-1, ISO 1711-1, ISO 691
- Chrome vanadium steel
- For manual use

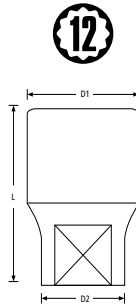

SKU #	Description	L (mm)	D1 (mm)	D2 (mm)	Weight (kg)	Box Qty
Imperial						
STMT89661-8B	3/4" 12 PTS Socket 3/4"	50	36	29.3	0.213	4
STMT89662-8B	3/4" 12 PTS Socket 13/16"	50	36	30.3	0.213	4
STMT89663-8B	3/4" 12 PTS Socket 7/8"	50	36	31.3	0.217	4
STMT89664-8B	3/4" 12 PTS Socket 15/16"	51	36	33.3	0.216	4
STMT89665-8B	3/4" 12 PTS Socket 1"	52	36	35	0.219	4
STMT89666-8B	3/4" 12 PTS Socket 1-1/16"	52	36	36	0.219	4
STMT89667-8B	3/4" 12 PTS Socket 1-1/8"	52	38	40	0.253	4
STMT89668-8B	3/4" 12 PTS Socket 1-3/16"	54	38	40	0.285	4
STMT89669-8B	3/4" 12 PTS Socket 1-1/4"	56	38	42	0.315	4
STMT89670-8B	3/4" 12 PTS Socket 1-5/16"	56	38	44	0.329	4
STMT89671-8B	3/4" 12 PTS Socket 1-3/8"	58	42	46	0.379	4
STMT89672-8B	3/4" 12 PTS Socket 1-7/16"	58	42	50	0.417	4
STMT89673-8B	3/4" 12 PTS Socket 1-1/2"	60	45	52	0.479	4
STMT89674-8B	3/4" 12 PTS Socket 1-5/8"	64	45	56	0.573	4
STMT89675-8B	3/4" 12 PTS Socket 1-11/16"	65	45	58	0.581	4
STMT89676-8B	3/4" 12 PTS Socket 1-3/4"	66	48	60	0.587	4
STMT89677-8B	3/4" 12 PTS Socket 1-13/16"	68	48	62	0.684	4
STMT89678-8B	3/4" 12 PTS Socket 1-7/8"	70	48	64	0.75	4
STMT89679-8B	3/4" 12 PTS Socket 2"	72	48	68	0.852	4



“ WHEN I TOLD MY TEAM THAT WE WERE UPGRADING OUR TOOL KITS TO STANLEY PRODUCTS, YOU CANNOT IMAGINE THE WAVES OF EXCITEMENT THAT RIPPLED THROUGH EVERYONE. WE KNOW THAT THE QUALITY OF OUR TOOLS REFLECTS THE PROFESSIONALISM OF OUR DUTY. ”

STANLEY®

IMPACT SOCKETS



Impact Sockets

Impact Bits

Accessories



IMPACT SOCKETS AND ACCESSORIES

STRENGTH BY DESIGN

Manufactured for use with air or electric power impact tools the **STANLEY® AUTOMOTIVE** Impact Standard Socket range are designed to stand up to extreme stresses - even in the toughest conditions.

The range includes a wide variety of common sizes and bit profiles as well as couplers, extension bars and bit holders, so you're never short of an option.

Clearly marked and manufactured from Chrome-Molybdenum steel with a black phosphate finish, they're fully certified and exceed ISO/DIN standards. The impact range is perfect for seized bolts and other high torque applications.



ANSI

American National Standards Institute



ISO

Accreditation by independent organization made up of members from the national standards bodies of 164 countries.

DIN

Accredited standards carried out by the German Institute for Standardisation.



IMPACT RANGE OVERVIEW

	Profile	Type	3/8" Drive	1/2" Drive	3/4" Drive
Socket	6PT	Standard	8-24mm	8-32mm	17-70mm
	6PT	Deep	8-24mm	8-36mm	17-46mm
Bit	Hex	-	-	5-19mm	-
	Torx	-	-	T25-T60	-
	Spline	-	-	M8-M12	-
Extension Bar	50mm			●	
	75mm		●		
	125mm			●	
	150mm		●		
	175mm				●
	250mm			●	●
Universal Joint			●	●	●
Bit Holder 5/16"			●	●	
Coupler	3/8" F - 1/2" M		●		
	1/2" F - 3/8" M			●	
	3/4" F - 1/2" M				●
Torx Socket	E10			●	
	E12			●	
	E14			●	
	E16			●	
	E18			●	
	E20			●	
	E24			●	

3/8" IMPACT STANDARD SOCKET SET - 9 PCS



- 3/8" Impact standard socket 8mm
- 3/8" Impact standard socket 9mm
- 3/8" Impact standard socket 10mm
- 3/8" Impact standard socket 11mm
- 3/8" Impact standard socket 12mm
- 3/8" Impact standard socket 13mm
- 3/8" Impact standard socket 14mm
- 3/8" Impact standard socket 17mm
- 3/8" Impact standard socket 19mm

SKU #	Description	L (mm)	W (mm)	Weight (kg)
STMT73918-8	9 PCS 3/8" Impact Standard Socket Set	300	100	0.705

3/8" IMPACT DEEP SOCKET SET - 9 PCS



- 3/8" Impact deep socket 8mm
- 3/8" Impact deep socket 9mm
- 3/8" Impact deep socket 10mm
- 3/8" Impact deep socket 11mm
- 3/8" Impact deep socket 12mm
- 3/8" Impact deep socket 13mm
- 3/8" Impact deep socket 14mm
- 3/8" Impact deep socket 17mm
- 3/8" Impact deep socket 19mm

SKU #	Description	L (mm)	W (mm)	Weight (kg)
STMT73919-8	9 PCS 3/8" Impact Deep Socket Set	300	130	1.257

1/2" IMPACT HEX BIT SET - 8 PCS



- 1/2" Impact hexagon bit 5mm
- 1/2" Impact hexagon bit 6mm
- 1/2" Impact hexagon bit 8mm
- 1/2" Impact hexagon bit 10mm
- 1/2" Impact hexagon bit 12mm
- 1/2" Impact hexagon bit 14mm
- 1/2" Impact hexagon bit 17mm
- 1/2" Impact hexagon bit 19mm

SKU #	Description	L (mm)	W (mm)	Weight (kg)
STMT73914-8	8 PCS 1/2" Impact Hex Bit Set	320	150	1.125

1/2" IMPACT TORX BIT SET - 8 PCS



- 1/2" Impact torx bit T25
- 1/2" Impact torx bit T27
- 1/2" Impact torx bit T30
- 1/2" Impact torx bit T40
- 1/2" Impact torx bit T45
- 1/2" Impact torx bit T50
- 1/2" Impact torx bit T55
- 1/2" Impact torx bit T60

SKU #	Description	L (mm)	W (mm)	Weight (kg)
STMT73915-8	8 PCS 1/2" Impact Torx Bit Set	320	150	0.8

1/2" IMPACT STANDARD SOCKET SET - 13 PCS



- 1/2" Impact standard socket 10mm
- 1/2" Impact standard socket 11mm
- 1/2" Impact standard socket 12mm
- 1/2" Impact standard socket 13mm
- 1/2" Impact standard socket 14mm
- 1/2" Impact standard socket 15mm
- 1/2" Impact standard socket 16mm
- 1/2" Impact standard socket 17mm
- 1/2" Impact standard socket 18mm
- 1/2" Impact standard socket 19mm
- 1/2" Impact standard socket 21mm
- 1/2" Impact standard socket 22mm
- 1/2" Impact standard socket 24mm

SKU #	Description	L (mm)	W (mm)	Weight (kg)
STMT73916-8	13 PCS 1/2" Impact Standard Socket Set	480	110	1.53

1/2" IMPACT DEEP SOCKET SET - 13 PCS



- 1/2" Impact deep socket 10mm
- 1/2" Impact deep socket 11mm
- 1/2" Impact deep socket 12mm
- 1/2" Impact deep socket 13mm
- 1/2" Impact deep socket 14mm
- 1/2" Impact deep socket 15mm
- 1/2" Impact deep socket 16mm
- 1/2" Impact deep socket 17mm
- 1/2" Impact deep socket 18mm
- 1/2" Impact deep socket 19mm
- 1/2" Impact deep socket 21mm

SKU #	Description	L (mm)	W (mm)	Weight (kg)
STMT73917-8	13 PCS 1/2" Impact Deep Socket Set	480	150	3.144

3/8" IMPACT EXTENSION

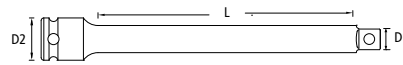

- ASME B107.10M, ISO 3316 - DIN 3123 - ISO 1174-1
- ASME B107.2, ISO 1174-2
- Designed specifically for impact tools - maximum performance and safety
- Chrome-Molybdenum steel



SKU #	Description	L (mm)	D1 (mm)	D2 (mm)	Weight (kg)	Box Qty
STMT73502-8B	3/8" Impact Extension 75mm	75	19	12.3	0.08	10
STMT73503-8B	3/8" Impact Extension 150mm	150	19	12.3	0.15	10

3/8" IMPACT UNIVERSAL JOINT

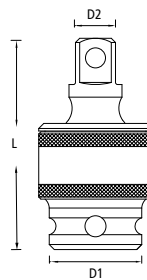

- ASME B107.10M, ISO 1174-2
- Designed specifically for impact tools - maximum performance and safety
- Chrome-Molybden



SKU #	Description	L (mm)	D1 (mm)	D2 (mm)	Weight (kg)	Box Qty
STMT73504-8B	3/8" Impact Universal Joint	50	22	27	0.093	10

3/8" IMPACT COUPLER

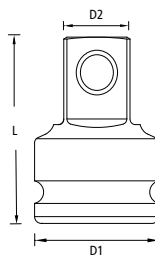

- ASME B107.2, ISO 1174-2
- Chrome-Molybdenum steel.
- Designed specifically for impact tools - maximum performance and safety



SKU #	Description	L (mm)	D1 (mm)	D2 (mm)	Weight (kg)	Box Qty
STMT73506-8B	3/8" Impact Coupler 3/8" F - 1/2" M	33	22	12.58	0.067	10

3/8" IMPACT BIT HOLDER

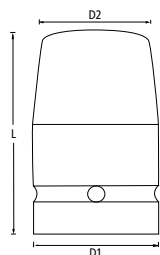

- ASME B107.2, ISO 1174-2
- Designed specifically for impact tools - maximum performance and safety



SKU #	Description	L (mm)	D1 (mm)	Weight (kg)	Box Qty
STMT73505-8B	3/8" Impact 5/16" Bit Holder	28	12.5	0.131	10

3/8" IMPACT STANDARD SOCKET

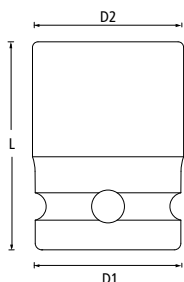

- ASME B107.33M, ASME B107.17M, DIN 7422, ISO 2725-2, ISO 1174-2, ISO 1711-2
- Designed specifically for impact tools - maximum performance and safety
- Chrome-Molybdenum steel



SKU #	Description	L (mm)	D1 (mm)	D2 (mm)	Weight (kg)	Box Qty
STMT73429-8B	3/8" Impact Standard Socket 8mm	29.5	19	12.7	0.032	10
STMT73430-8B	3/8" Impact Standard Socket 9mm	29.5	19	14	0.034	10
STMT73431-8B	3/8" Impact Standard Socket 10mm	29.5	19	15.2	0.034	10
STMT73432-8B	3/8" Impact Standard Socket 11mm	29.5	19	17	0.037	10
STMT73433-8B	3/8" Impact Standard Socket 12mm	29.5	19	18	0.04	10
STMT73434-8B	3/8" Impact Standard Socket 13mm	29.5	19	20	0.044	10
STMT73435-8B	3/8" Impact Standard Socket 14mm	29.5	19	21.5	0.054	10
STMT73436-8B	3/8" Impact Standard Socket 15mm	29.5	19	22	0.054	10
STMT73437-8B	3/8" Impact Standard Socket 16mm	30	22	23.5	0.067	10
STMT73438-8B	3/8" Impact Standard Socket 17mm	30	22	24	0.067	10
STMT73439-8B	3/8" Impact Standard Socket 18mm	30	22	25	0.07	10
STMT73440-8B	3/8" Impact Standard Socket 19mm	30	22	26	0.072	10
STMT73441-8B	3/8" Impact Standard Socket 21mm	30	22	28	0.08	10
STMT73442-8B	3/8" Impact Standard Socket 22mm	30	22	30	0.095	10
STMT73443-8B	3/8" Impact Standard Socket 24mm	30	22	32	0.11	10

3/8" IMPACT DEEP SOCKET

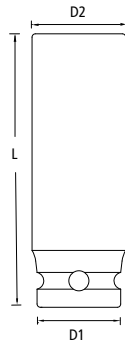

- ASME B107.33M, ASME B107.17M, DIN 7422, ISO 2725-2, ISO 1174-2, ISO 1711-2
- Designed specifically for impact tools - maximum performance and safety
- Chrome-Molybdenum steel



SKU #	Description	L (mm)	D1 (mm)	D2 (mm)	Weight (kg)	Box Qty
STMT73444-8B	3/8" Impact Deep Socket 8mm	64	19	12.7	0.077	10
STMT73445-8B	3/8" Impact Deep Socket 9mm	64	19	14	0.08	10
STMT73446-8B	3/8" Impact Deep Socket 10mm	64	19	15.2	0.08	10
STMT73447-8B	3/8" Impact Deep Socket 11mm	64	19	17	0.08	10
STMT73448-8B	3/8" Impact Deep Socket 12mm	64	19	18	0.08	10
STMT73449-8B	3/8" Impact Deep Socket 13mm	64	19	20	0.09	10
STMT73450-8B	3/8" Impact Deep Socket 14mm	64	19	21	0.095	10
STMT73451-8B	3/8" Impact Deep Socket 15mm	64	19	22	0.102	10
STMT73452-8B	3/8" Impact Deep Socket 16mm	64	22	23	0.108	10
STMT73453-8B	3/8" Impact Deep Socket 17mm	64	22	24	0.12	10
STMT73454-8B	3/8" Impact Deep Socket 18mm	64	22	25	0.12	10
STMT73455-8B	3/8" Impact Deep Socket 19mm	64	22	26	0.125	10
STMT73456-8B	3/8" Impact Deep Socket 21mm	64	22	28	0.14	10
STMT73457-8B	3/8" Impact Deep Socket 22mm	64	22	30	0.16	10
STMT73458-8B	3/8" Impact Deep Socket 24mm	64	22	32	0.16	10



“ STANLEY’S RANGE OF AIR TOOLS WHOLLY COMPLEMENT THE IMPACT SOCKETS SO THERE IS NO REASON NOT TO USE THE TWO OF THEM TOGETHER. ”

1/2" IMPACT EXTENSION

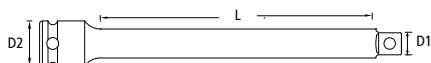

- ASME B107.2, ISO 1174-2
- Designed specifically for impact tools - maximum performance and safety
- Chrome-Molybdenum steel



SKU #	Description	L (mm)	D1 (mm)	D2 (mm)	Weight (kg)	Box Qty
STMT73493-8B	1/2" Impact Extension 50mm	50	25	16.5	0.11	10
STMT73494-8B	1/2" Impact Extension 125mm	125	25	16.5	0.226	10
STMT73495-8B	1/2" Impact Extension 250mm	250	25	16.5	0.427	10

1/2" IMPACT UNIVERSAL JOINT

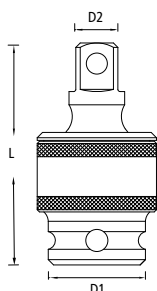

- ASME B107.2, ISO 1174-2
- Designed specifically for impact tools - maximum performance and safety
- Chrome-Molybdenum steel



SKU #	Description	L (mm)	D1 (mm)	D2 (mm)	Weight (kg)	Box Qty
STMT73497-8B	1/2" Impact Universal Joint	63	30	34	0.194	10



“ I BELIEVE THAT WITH THE RIGHT TOOLS, ANYTHING IS POSSIBLE. STANLEY'S WIDE VARIETY OF PRODUCTS HAS ENABLED ME TO PROVE NOT JUST TO THE WORLD, BUT TO MYSELF WHAT I CAN ACCOMPLISH. ”

1/2" IMPACT BIT HOLDER

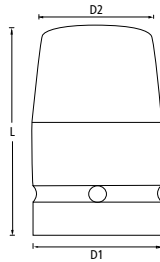

- ASME B107.2, ISO 1174-2
- Designed specifically for impact tools - maximum performance and safety



SKU #	Description	L (mm)	D1 (mm)	Weight (kg)	Box Qty
STMT73496-8B	1/2" Impact 5/16" Bit Holder	38	17	0.8	10

1/2" IMPACT COUPLER

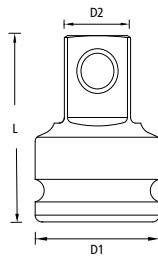

- ASME B107.2, ISO 1174-2
- Chrome-Molybdenum steel.
- Designed specifically for impact tools - maximum performance and safety



SKU #	Description	L (mm)	D1 (mm)	D2 (mm)	Weight (kg)	Box Qty
STMT73507-8B	1/2" Impact Coupler 1/2" F - 3/8" M	38	25	10	0.07	10



“ YEAR AGO I HURT MYSELF RATHER BADLY WHEN I PAIRED A STANDARD SOCKET WITH AN AIR TOOL. EVER SINCE THEN I AM VERY PARTICULAR ABOUT ONLY USING IMPACT SOCKETS AS WORK SAFETY SHOULD NEVER BE COMPROMISED FOR CONVENIENCE. ”

1/2" IMPACT HEXAGON BIT

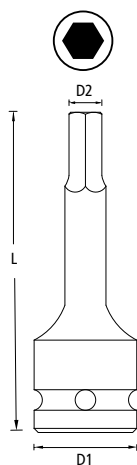

- DIN 7422, ISO 1174-2
- SNCM
- Designed specifically for impact tools - maximum performance and safety
- One piece screwdriver sockets



SKU #	Description	L (mm)	D1 (mm)	A (mm)	Weight (kg)	Box Qty
STMT73477-8B	1/2" Impact Hexagon Bit 5mm	78	25	5	0.075	10
STMT73478-8B	1/2" Impact Hexagon Bit 6mm	78	25	6	0.08	10
STMT73479-8B	1/2" Impact Hexagon Bit 8mm	78	25	8	0.09	10
STMT73480-8B	1/2" Impact Hexagon Bit 10mm	78	25	10	0.105	10
STMT73481-8B	1/2" Impact Hexagon Bit 12mm	78	25	12	0.125	10
STMT73482-8B	1/2" Impact Hexagon Bit 14mm	78	25	14	0.15	10
STMT73483-8B	1/2" Impact Hexagon Bit 17mm	78	25	17	0.185	10
STMT73484-8B	1/2" Impact Hexagon Bit 19mm	78	25	19	0.215	10

1/2" IMPACT SPLINE BIT

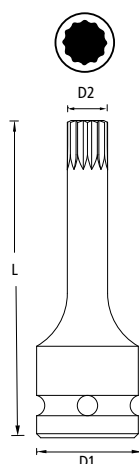

- DIN 7422, ISO 1174-2
- SNCM
- Designed specifically for impact tools - maximum performance and safety



SKU #	Description	L (mm)	D1 (mm)	A (mm)	Weight (kg)	Box Qty
STMT73508-8B	1/2" Impact Spline Bit M8	78	25	M8	0.08	10
STMT73509-8B	1/2" Impact Spline Bit M10	78	25	M10	0.09	10
STMT73510-8B	1/2" Impact Spline Bit M12	78	25	M12	0.1	10

1/2" IMPACT TORX BIT

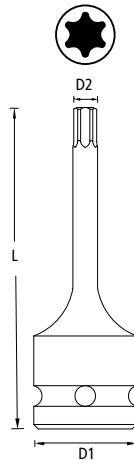

- DIN 7422, ISO 1174-2
- SNCM
- Designed specifically for impact tools - maximum performance and safety
- One piece screwdriver sockets



SKU #	Description	L (mm)	D1 (mm)	A (mm)	Weight (kg)	Box Qty
STMT73485-8B	1/2" Impact Torx Bit, T25	78	25	T25	0.7	10
STMT73486-8B	1/2" Impact Torx Bit, T27	78	25	T27	0.7	10
STMT73487-8B	1/2" Impact Torx Bit, T30	78	25	T30	0.8	10
STMT73488-8B	1/2" Impact Torx Bit, T40	78	25	T40	0.75	10
STMT73489-8B	1/2" Impact Torx Bit, T45	78	25	T45	0.9	10
STMT73490-8B	1/2" Impact Torx Bit, T50	78	25	T50	0.9	10
STMT73491-8B	1/2" Impact Torx Bit, T55	78	25	T55	0.105	10
STMT73492-8B	1/2" Impact Torx Bit, T60	78	25	T60	0.2	10

1/2" IMPACT TORX SOCKET

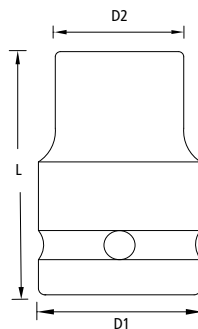

- DIN 7422, ISO 1174-2
- SNCM
- Designed specifically for impact tools - maximum performance and safety
- One piece screwdriver sockets



SKU #	Description	L (mm)	D1 (mm)	D2 (mm)	Weight (kg)	Box Qty
STMT73511-8B	1/2" Impact Torx Socket E10	38	25	13.8	0.05	10
STMT73512-8B	1/2" Impact Torx Socket E12	38	25	15.8	0.051	10

SKU #	Description	L (mm)	D1 (mm)	D2 (mm)	Weight (kg)	Box Qty
STMT73513-8B	1/2" Impact Torx Socket E14	38	25	17.8	0.053	10
STMT73514-8B	1/2" Impact Torx Socket E16	38	25	19.8	0.056	10
STMT73515-8B	1/2" Impact Torx Socket E18	38	25	21.8	0.059	10
STMT73516-8B	1/2" Impact Torx Socket E20	38	25	23.8	0.074	10
STMT73517-8B	1/2" Impact Torx Socket E24	38	30	28.5	0.109	10

1/2" IMPACT STANDARD SOCKET

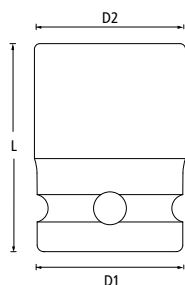

- ASME B107.33M, ASME B107.17M, DIN 7422, ISO 2725-2, ISO 1174-2, ISO 1711-2
- Designed specifically for impact tools - maximum performance and safety
- Chrome-Molybdenum steel



SKU #	Description	L (mm)	D1 (mm)	D2 (mm)	Weight (kg)	Box Qty
STMT89435-8B	1/2" Impact Standard Socket 8mm	38	25	14.5	0.067	10
STMT89436-8B	1/2" Impact Standard Socket 9mm	38	25	15.6	0.068	10
STMT89437-8B	1/2" Impact Standard Socket 10mm	38	25	16.7	0.068	10
STMT89438-8B	1/2" Impact Standard Socket 11mm	38	25	18	0.07	10
STMT89439-8B	1/2" Impact Standard Socket 12mm	38	25	19	0.071	10
STMT89440-8B	1/2" Impact Standard Socket 13mm	38	25	20.2	0.072	10
STMT89441-8B	1/2" Impact Standard Socket 14mm	38	25	21.5	0.074	10
STMT89442-8B	1/2" Impact Standard Socket 15mm	38	25	23	0.076	10
STMT89443-8B	1/2" Impact Standard Socket 16mm	38	25	24.5	0.077	10
STMT89444-8B	1/2" Impact Standard Socket 17mm	38	25	26	0.082	10
STMT89445-8B	1/2" Impact Standard Socket 18mm	38	25	27	0.084	10
STMT89446-8B	1/2" Impact Standard Socket 19mm	38	25	28	0.087	10
STMT89447-8B	1/2" Impact Standard Socket 20mm	38	25	30	0.09	10
STMT89448-8B	1/2" Impact Standard Socket 21mm	38	25	30	0.093	10
STMT89449-8B	1/2" Impact Standard Socket 22mm	38	30	32	0.127	10
STMT89450-8B	1/2" Impact Standard Socket 23mm	38	30	34	0.13	10
STMT89451-8B	1/2" Impact Standard Socket 24mm	38	30	34	0.131	10
STMT89452-8B	1/2" Impact Standard Socket 25mm	42	30	36	0.162	10
STMT89453-8B	1/2" Impact Standard Socket 26mm	42	30	38	0.157	10
STMT89454-8B	1/2" Impact Standard Socket 27mm	42	30	40	0.172	10
STMT89455-8B	1/2" Impact Standard Socket 28mm	42	30	40	0.175	10
STMT89456-8B	1/2" Impact Standard Socket 30mm	42	30	42	0.192	10
STMT89457-8B	1/2" Impact Standard Socket 31mm	42	30	44	0.195	10
STMT89458-8B	1/2" Impact Standard Socket 32mm	42	30	44	0.201	10

1/2" IMPACT DEEP SOCKET

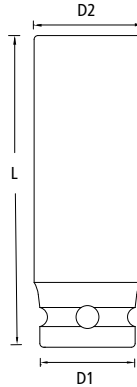

- ASME B107.33M, ASME B107.17M, DIN 7422, ISO 2725-2, ISO 1174-2, ISO 1711-2
- Designed specifically for impact tools - maximum performance and safety
- Chrome-Molybdenum steel



SKU #	Description	L (mm)	D1 (mm)	D2 (mm)	Weight (kg)	Box Qty
STMT95700-8B	1/2" Impact Deep Socket 8mm	82	25	14.5	0.114	10
STMT95711-8B	1/2" Impact Deep Socket 9mm	82	25	15.6	0.12	10
STMT92959-8B	1/2" Impact Deep Socket 10mm	82	25	16.7	0.128	10
STMT92960-8B	1/2" Impact Deep Socket 11mm	82	25	18	0.132	10
STMT91379-8B	1/2" Impact Deep Socket 12mm	82	25	19	0.14	10
STMT87500-8B	1/2" Impact Deep Socket 13mm	82	25	20.2	0.149	10
STMT87501-8B	1/2" Impact Deep Socket 14mm	82	25	21.5	0.153	10
STMT87502-8B	1/2" Impact Deep Socket 15mm	82	25	23	0.169	10
STMT91380-8B	1/2" Impact Deep Socket 16mm	82	25	24	0.167	10
STMT87504-8B	1/2" Impact Deep Socket 17mm	82	25	26	0.2	10
STMT87505-8B	1/2" Impact Deep Socket 18mm	82	25	27	0.208	10
STMT91391-8B	1/2" Impact Deep Socket 20mm	82	25	29	0.235	10
STMT87507-8B	1/2" Impact Deep Socket 21mm	82	25	30	0.243	10
STMT87508-8B	1/2" Impact Deep Socket 22mm	82	30	32	0.29	10
STMT91392-8B	1/2" Impact Deep Socket 23mm	82	30	33	0.291	10
STMT91393-8B	1/2" Impact Deep Socket 24mm	82	30	34	0.314	10
STMT91394-8B	1/2" Impact Deep Socket 25mm	82	30	36	0.351	10
STMT91395-8B	1/2" Impact Deep Socket 26mm	82	30	36	0.36	10
STMT91396-8B	1/2" Impact Deep Socket 27mm	82	30	38	0.374	10
STMT91397-8B	1/2" Impact Deep Socket 28mm	82	30	40	0.4	10
STMT91398-8B	1/2" Impact Deep Socket 29mm	82	30	41	0.425	10
STMT91403-8B	1/2" Impact Deep Socket 30MM	82	30	42	0.432	10
STMT73459-8B	1/2" Impact Deep Socket 31MM	82	30	43	0.44	10
STMT73460-8B	1/2" Impact Deep Socket 32MM	82	30	44	0.45	10
STMT73461-8B	1/2" Impact Deep Socket 33MM	82	35	46	0.471	10
STMT73462-8B	1/2" Impact Deep Socket 34MM	82	35	48	0.528	10
STMT73463-8B	1/2" Impact Deep Socket 36MM	82	35	50	0.548	10

3/4" IMPACT EXTENSION

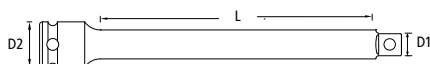

- ASME B107.2, ISO 1174-2
- Designed specifically for impact tools - maximum performance and safety
- Chrome-Molybdenum steel



SKU #	Description	L (mm)	D1 (mm)	D2 (mm)	Weight (kg)	Box Qty
STMT73498-8B	3/4" Impact Extension 175mm	175	44	25	0.194	2
STMT73499-8B	3/4" Impact Extension 250mm	250	44	25	1.17	2

3/4" IMPACT UNIVERSAL JOINT

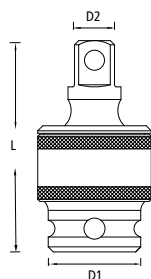

- ASME B107.10M, ISO 1174-2
- Designed specifically for impact tools - maximum performance and safety
- Chrome-Molybden



SKU #	Description	L (mm)	D1 (mm)	D2 (mm)	Weight (kg)	Box Qty
STMT73500-8B	3/4" Impact Universal Joint	90	44	49.2	0.61	4

3/4" IMPACT COUPLER

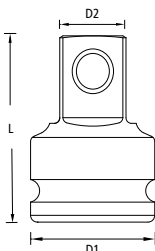

- ASME B107.2, ISO 1174-2
- Chrome-Molybdenum steel.
- Designed specifically for impact tools - maximum performance and safety



SKU #	Description	L (mm)	D1 (mm)	D2 (mm)	Weight (kg)	Box Qty
STMT73501-8B	3/4" Impact Coupler 3/4" F - 1/2" M	56	44	16.5	0.308	4

3/4" IMPACT STANDARD SOCKET

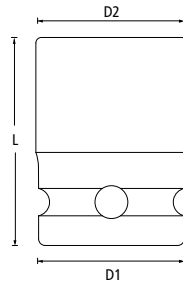

- ASME B107.33M, ASME B107.17M, DIN 7422, ISO 2725-2, ISO 1174-2, ISO 1711-2
- Designed specifically for impact tools - maximum performance and safety
- Chrome-Molybdenum steel



SKU #	Description	L (mm)	D1 (mm)	D2 (mm)	Weight (kg)	Box Qty
STMT89395-8B	3/4" 6 PTS Impact Standard Socket 17mm	51	44	30	0.33	5
STMT89396-8B	3/4" 6 PTS Impact Standard Socket 18mm	51	44	31	0.33	4
STMT89397-8B	3/4" 6 PTS Impact Standard Socket 19mm	51	44	32.5	0.34	5
STMT89398-8B	3/4" 6 PTS Impact Standard Socket 20mm	51	44	33.5	0.34	4
STMT89399-8B	3/4" 6 PTS Impact Standard Socket 21mm	51	44	35	0.35	4
STMT89400-8B	3/4" 6 PTS Impact Standard Socket 22mm	51	44	36	0.35	5
STMT89401-8B	3/4" 6 PTS Impact Standard Socket 23mm	51	44	37.5	0.36	4
STMT89402-8B	3/4" 6 PTS Impact Standard Socket 24mm	51	44	38.5	0.37	4
STMT89403-8B	3/4" 6 PTS Impact Standard Socket 25mm	53	44	40	0.38	4
STMT89404-8B	3/4" 6 PTS Impact Standard Socket 26mm	53	44	41	0.38	5
STMT89405-8B	3/4" 6 PTS Impact Standard Socket 27mm	53	44	42.5	0.39	5
STMT89406-8B	3/4" 6 PTS Impact Standard Socket 28mm	53	44	44	0.4	5
STMT89407-8B	3/4" 6 PTS Impact Standard Socket 29mm	53	44	45	0.4	4
STMT89408-8B	3/4" 6 PTS Impact Standard Socket 30mm	53	44	46	0.43	5
STMT89409-8B	3/4" 6 PTS Impact Standard Socket 31mm	57	44	47	0.45	4
STMT89410-8B	3/4" 6 PTS Impact Standard Socket 32mm	57	44	48	0.46	4
STMT89411-8B	3/4" 6 PTS Impact Standard Socket 33mm	57	44	50	0.48	4
STMT89412-8B	3/4" 6 PTS Impact Standard Socket 34mm	57	44	51	0.5	4
STMT89413-8B	3/4" 6 PTS Impact Standard Socket 35mm	57	44	52	0.5	4
STMT89414-8B	3/4" 6 PTS Impact Standard Socket 36mm	57	44	53	0.51	4
STMT89415-8B	3/4" 6 PTS Impact Standard Socket 37mm	57	44	55	0.52	4
STMT89416-8B	3/4" 6 PTS Impact Standard Socket 38mm	57	44	56	0.55	4
STMT89417-8B	3/4" 6 PTS Impact Standard Socket 40mm	58	44	58	0.59	2
STMT89418-8B	3/4" 6 PTS Impact Standard Socket 41mm	58	44	59	0.65	4
STMT73464-8B	3/4" 6 PTS Impact Standard Socket 42mm	58	44	61	0.67	2
STMT89419-8B	3/4" 6 PTS Impact Standard Socket 43mm	62	44	62	0.68	2
STMT89420-8B	3/4" 6 PTS Impact Standard Socket 45mm	62	44	65	0.685	2
STMT89421-8B	3/4" 6 PTS Impact Standard Socket 46mm	62	44	66	0.7	2
STMT89422-8B	3/4" 6 PTS Impact Standard Socket 48mm	68	44	69	0.81	2
STMT89423-8B	3/4" 6 PTS Impact Standard Socket 50mm	68	44	71	0.83	2
STMT89424-8B	3/4" 6 PTS Impact Standard Socket 52mm	72	44	74	0.91	2
STMT89425-8B	3/4" 6 PTS Impact Standard Socket 54mm	72	44	76	1.02	2

SKU #	Description	L (mm)	D1 (mm)	D2 (mm)	Weight (kg)	Box Qty
STMT89426-8B	3/4" 6 PTS Impact Standard Socket 55mm	72	54	77.5	1.1	2
STMT73465-8B	3/4" 6 PTS Impact Standard Socket 56mm	74	54	79	1.1	2
STMT89427-8B	3/4" 6 PTS Impact Standard Socket 57mm	74	54	80	1.15	2
STMT89428-8B	3/4" 6 PTS Impact Standard Socket 58mm	74	54	81	1.15	2
STMT89429-8B	3/4" 6 PTS Impact Standard Socket 59mm	75	54	82	1.2	2
STMT89430-8B	3/4" 6 PTS Impact Standard Socket 60mm	75	54	84	1.295	2
STMT89431-8B	3/4" 6 PTS Impact Standard Socket 63mm	75	54	86	1.36	1
STMT89432-8B	3/4" 6 PTS Impact Standard Socket 65mm	78	54	88	1.5	1
STMT73466-8B	3/4" 6 PTS Impact Standard Socket 67mm	82	60	92	1.7	1
STMT89433-8B	3/4" 6 PTS Impact Standard Socket 70mm	85	60	95	1.9	1

3/4" IMPACT DEEP SOCKET

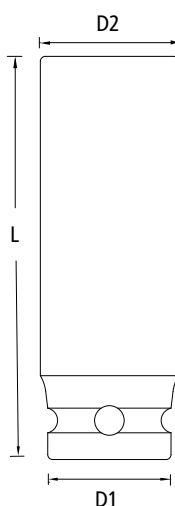

- ASME B107.33M, ASME B107.17M, DIN 7422, ISO 2725-2, ISO 1174-2, ISO 1711-2
- Designed specifically for impact tools - maximum performance and safety
- Chrome-Molybdenum steel



SKU #	Description	L (mm)	D1 (mm)	D2 (mm)	Weight (kg)	Box Qty
STMT73467-8B	3/4" 6 PTS Impact Deep Socket 17mm	90	44	30	0.49	2
STMT73468-8B	3/4" 6 PTS Impact Deep Socket 19mm	90	44	32	0.5	2
STMT73469-8B	3/4" 6 PTS Impact Deep Socket 24mm	90	44	38.3	0.58	2
STMT73470-8B	3/4" 6 PTS Impact Deep Socket 27mm	90	44	42	0.63	2
STMT73471-8B	3/4" 6 PTS Impact Deep Socket 30mm	90	44	46	0.7	2
STMT73472-8B	3/4" 6 PTS Impact Deep Socket 32mm	90	44	48	0.74	2
STMT73473-8B	3/4" 6 PTS Impact Deep Socket 33mm	90	44	50	0.77	2
STMT73474-8B	3/4" 6 PTS Impact Deep Socket 36mm	90	44	53	0.85	2
STMT73475-8B	3/4" 6 PTS Impact Deep Socket 41mm	90	44	59	0.95	2
STMT73476-8B	3/4" 6 PTS Impact Deep Socket 46mm	90	44	66	1.08	2

STANLEY®

TORQUE WRENCHES

1/4" Drive

3/8" Drive

1/2" Drive

3/4" Drive

Repair Kits





PROFESSIONAL FINISH

Precision torque setting for high or low loading.

POWER WITH PRECISION

VERSATILE AND ACCURATE

Quality manufactured from Chrome Vanadium **STANLEY®** Torque wrenches provide top levels of accuracy with easy to use features.

The Chrome - Molybdenum drives and locking pawl are built to withstand heavy use in the workshop.

Clear, dual scale engraved markings are easy to read and the knurled ring provides rapid torque setting adjustment. Designed for left or right rotations with audible click it's easy to get the job torqued up correctly.

The range includes in 1/4", 3/8", 1/2" and 3/4" drive options and covers torques from 5 up to 750 Nm - broad enough for a wide range of professional applications.

Every Torque wrench features a unique serial number for complete traceability and comes complete with a calibration certificate in blow molded case.



CERTIFIED PERFORMANCE

Tested to extremes, the **STANLEY® AUTOMOTIVE** Torque wrench range complies with ISO 6789 & ASME B107.14 - giving a consistent result and professional performance every time.

Accuracy - +/- 4%

Reliability - tested over 20,000 click cycles

Load Tested - 25% above load capacity

STANLEY®		Stanley Black & Decker					
Tel: 886 4 25606521 Fax: 886 4 25606528		www.stanleyblackanddecker.com					
Certificate of Calibration							
Model :	5-25 N.m	Tolerance :	± 1%				
Serial No. :	131112006001	Units :	N.m				
Maximum Capacity :	25	Lab :					
Inspector :		Ambient Temperature :	20.7				
Set Torque	Min	Max	Actual Readings				
5	4.8	5.2	5	4.96	5.014	5.02	5.02
15	14.4	15.6	15.21	15.18	15.18	15.09	15.1
25	24	26	25.31	25.3	25.25	25.24	25.3
The limits shown are the test Equipment used for this calibration comply with the requirements of ISO 6789:2009							
The uncertainty of the test equipment used is ± 0.1%							
The test equipment used in the performance of the above calibration has international traceability through :							
Tester made :	Nether Mold No/32.9			Date of Calibration			
Serial No. :	68165			22/1/2013			
Laboratory No. :	UKAS 6206			Quality Manager			



ISO
Accreditation by independent organization made up of members from the national standards bodies of 164 countries.



ANSI
American National Standards Institute



Audible Indicator
for precision tightening



Dual Scale
Easy to read Nm / lb-ft markings

GETTING THE BEST OUT OF A TORQUE WRENCH

INFORMATION & ADVICE

As a precision instrument, the **STANLEY®** Torque wrench range is designed along best practice principles. To preserve the set calibration, the tool should be reset to 10% of the maximum capable load after each use. In order to provide a secure fastening without the risk of distortion, it is important to follow correct tightening sequences.

RADIAL APPLICATIONS

For wheels and other radial applications, it is important to tighten the fasteners following the traditional star pattern sequence shown in the diagram on the right.

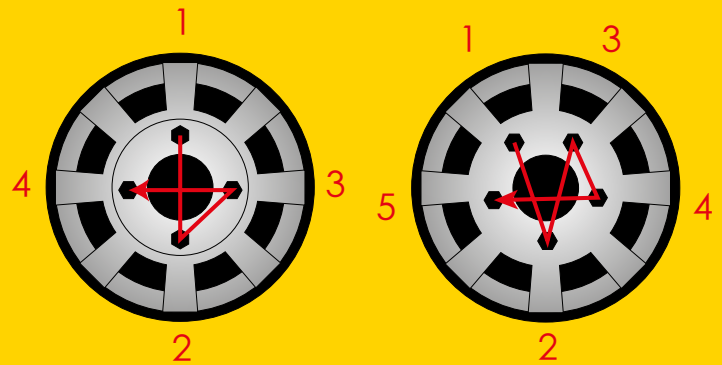

CYLINDER HEAD APPLICATIONS

Always start in the middle of the engine, between cylinders 2 and 3 for a 4 cylinder engine. Move outwards in a spiral or crosswise outward direction along both sides. Tighten gradually, increasing the torque in stages on each fastener to ensure an even clamping force, until the outer bolts on Cylinders 1 and 4 have been tightened

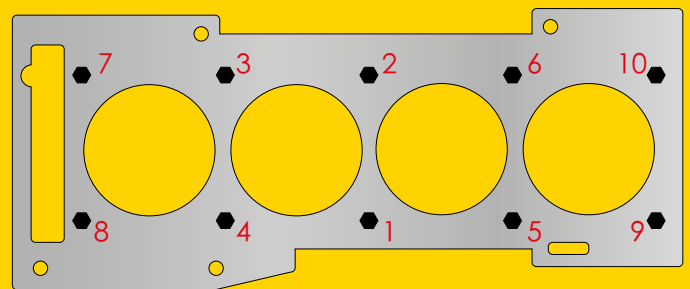

FORMULA FOR CALCULATING THE EFFECT OF TORQUE WRENCH EXTENSIONS

In cases whereby special attachments change the calibration of the torque wrench or when it is impractical to use regular sockets (such as whilst tightening threaded connectors), it is necessary to calculate the accurate settings using the formulas shown in the diagram opposite:

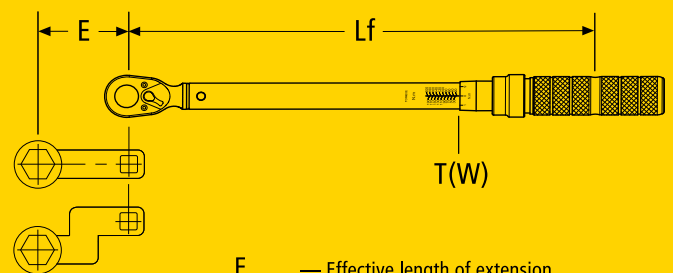

- E — Effective length of extension
- Lf — Lever length of the wrench: middle of handle to center of square drive
- T(W) — Torque setting on the wrench
- T(A) — Torque applied by the extension to the fastener
- T(A) — $T(W) \times \frac{L_f + E}{L_f}$

CONSISTENT PERFORMANCE, +/- 4% ACCURACY EVEN AFTER 20,000 CYCLES

Robust build quality and precision manufacture ensures **STANLEY**® Torque wrenches Meet and beat current standards, delivering reliability, day after day - year after year.

RELIABILITY OF MECHANISM

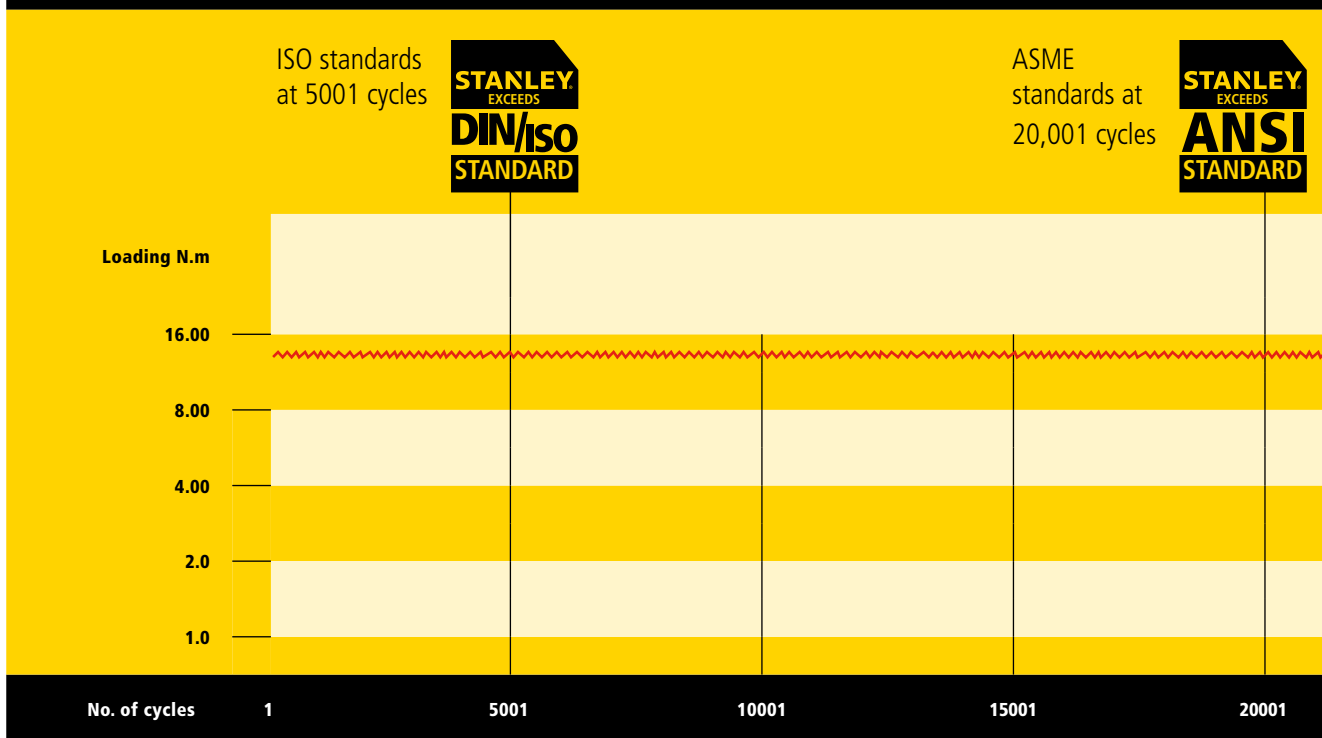

Test carried out using 1/4" drive, 5 - 25N.m 50% loading

TORQUE WRENCH COMPARATOR

SKU #	Description	Drive Size	Torque Range		Increments N-m	Width (mm)	Length (mm)	Weight (kg)
STMT73587-8	1/4" TORQUE WRENCH 5-25 Nm	1/4"	5 - 25N-m	39.8-225.7 in-lb	0.1 N-m	22.5	246	0.365
STMT73588-8	3/8" TORQUE WRENCH 10-50Nm	3/8"	10 - 50N-m	9.2-38.7 ft-lb	0.5 N-m	31	409	1.182
STMT73589-8	1/2" TORQUE WRENCH 20-100Nm	1/2"	20 - 100N-m	16.6-75.6 ft-lb	0.5 N-m	31	409	1.19
STMT73590-8	1/2" TORQUE WRENCH 40-200Nm	1/2"	40 - 200N-m	33.2-151.2 ft-lb	1 N-m	41	519	1.6
STMT73591-8	1/2" TORQUE WRENCH 60-340Nm	1/2"	60 - 340N-m	51.6-258.1 ft-lb	2 N-m	41	610	1.785
STMT73592-8	3/4" TORQUE WRENCH 150-750Nm	3/4"	150 - 750N-m	110-550 ft-lb	2.5 N-m	58	1112	5.87

DUAL WAY TORQUE WRENCH

48 GEAR TEETH FOR SMALL INCREMENT SETTING

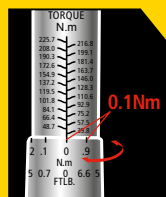

“ THIS TOOL HAS A SMOOTH ACTION AND FINE RATCHET, PLUS THE ABILITY TO TIGHTEN ACCURATELY IN BOTH DIRECTIONS. ”

1/4" TORQUE WRENCH 5-25 NM

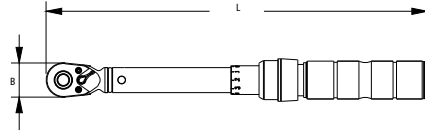

- ISO 6789, ASME B107.14
- Accuracy: +/- 4%
- Visual and audible indication
- Dual Way direction(C.W./C.C.W.) click Type
- Dual scales (N-m & in-lb.)
- Quick release button
- Adjusting ring locking system
- Aluminum Alloy handle with anodic treatment
- Si-Cr-Mo spring
- Cr-Mo pawl
- Cr-Mo square driver
- 48 Gear teeth



SKU #	Description	Drive Size	Torque Range	Torque Range	Increment	B (mm)	L (mm)	Weight (kg)
STMT73587-8	1/4" Torque Wrench 5-25 N-m	1/4"	5-25 N-m	48.7-225.7 in-lb.	0.1 N-m	22.5	246	0.365

3/8" TORQUE WRENCH 10-50NM

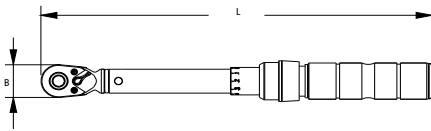

- ISO 6789, ASME B107.14
- Accuracy: +/- 4%
- Visual and audible indication
- Dual Way direction(C.W./C.C.W.) click Type
- Dual scales (N-m & ft-lb.)
- Quick release button
- Adjusting ring locking system
- Aluminum Alloy handle with anodic treatment
- Si-Cr-Mo spring
- Cr-Mo pawl
- Cr-Mo square driver
- 48 Gear teeth



SKU #	Description	Drive Size	Torque Range	Torque Range	Increment	B (mm)	L (mm)	Weight (kg)
STMT73588-8	3/8" Torque Wrench 10-50N-m	3/8"	10-50 N-m	9.2-38.7 ft-lb	0.5 N-m	31	409	1.182

1/2" TORQUE WRENCH 20-100NM

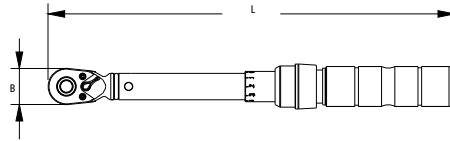

- ISO 6789, ASME B107.14
- Accuracy: +/- 4%
- Visual and audible indication
- Dual Way direction(C.W./C.C.W.) click Type
- Dual scales (N-m & ft-lb)
- Quick release button
- Adjusting ring locking system
- Aluminum Alloy handle with anodic treatment
- Si-Cr-Mo spring
- Cr-Mo pawl
- Cr-Mo square driver
- 48 Gear teeth



SKU #	Description	Drive Size	Torque Range	Torque Range	Increment	B (mm)	L (mm)	Weight (kg)
STMT73589-8	1/2" Torque Wrench 20-100N-m	1/2"	20-100 N-m	16.6-75.6 ft-lb	0.5 N-m	31	409	1.19

1/2" TORQUE WRENCH 40-200NM

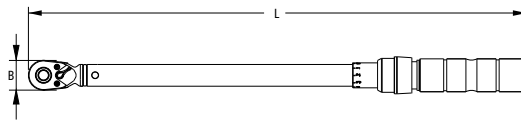

- ISO 6789, ASME B107.14
- Accuracy: +/- 4%
- Visual and audible indication
- Dual Way direction(C.W./C.C.W.) Click Type
- Dual scales (N-m & ft-lb)
- Quick release button
- Adjusting ring locking system
- Aluminum Alloy handle with anodic treatment
- Si-Cr-Mo spring
- Cr-Mo pawl
- Cr-Mo square driver
- 48 Gear teeth



SKU #	Description	Drive Size	Torque Range	Torque Range	Increment	B (mm)	L (mm)	Weight (kg)
STMT73590-8	1/2" Torque Wrench 40-200N-m	1/2"	40-200 N-m	33.2-151.2 ft-lb	1 N-m	41	519	1.6

1/2" TORQUE WRENCH 60-340NM

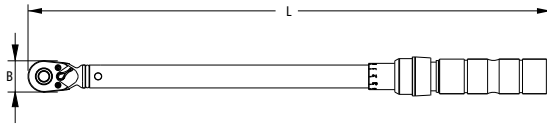

- ISO 6789, ASME B107.14
- Accuracy: +/- 4%
- Visual and audible indication
- Dual Way direction(C.W./C.C.W.) click Type
- Dual scales (N-m & ft-lb)
- Quick release button
- Adjusting ring locking system
- Aluminum Alloy handle with anodic treatment
- Si-Cr-Mo spring
- Cr-Mo pawl
- Cr-Mo square driver
- 48 Gear teeth



SKU #	Description	Drive Size	Torque Range	Torque Range	Increment	B (mm)	L (mm)	Weight (kg)
STMT73591-8	1/2" Torque Wrench 60-340N-m	1/2"	60-340 N-m	51.6-258.1 ft-lb	2 N-m	41	610	1.785

3/4" TORQUE WRENCH 150-750NM

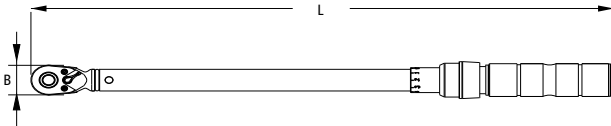

- ISO 6789, ASME B107.14
- Accuracy: +/- 4%
- Visual and audible indication
- Dual Way direction(C.W./C.C.W.) click Type
- Dual scales (N-m & ft-lb)
- Quick release button
- Adjusting ring locking system
- Aluminum Alloy handle with anodic treatment
- Si-Cr-Mo spring
- Cr-Mo pawl
- Cr-Mo square driver
- 48 Gear teeth



SKU #	Description	Drive Size	Torque Range	Torque Range	Increment	B (mm)	L (mm)	Weight (kg)
STMT73592-8	3/4" Torque Wrench 150-750N-m	3/4"	150-750 N-m	110-550 ft-lb	2.5 N-m	58	1112	5.87

REPAIR KITS



- 1/4" Square Drive × 1pc, Pawl × 1pc, Switch × 1pc, Steel Ball × 1pc, Screw × 2pcs, Spring × 1pc, Steel Cover × 1pc.
- 3/8" Square Drive × 1pc, Pawl × 1pc, Switch × 1pc, Steel Ball × 1pc, Screw × 3pcs, Spring × 1pc, Steel Cover × 1pc.
- 1/2" Square Drive × 1pc, Pawl × 1pc, Switch × 1pc, Steel Ball × 1pc, Screw × 3pcs, Spring × 1pc, Steel Cover × 1pc.
- 3/4" Square Drive × 1pc, Pawl × 1pc, Switch × 1pc, Steel Ball × 1pc, Screw × 3pcs, Spring × 1pc, Steel Cover × 1pc.



SKU #	Description	Drive Size	Carton Qty
STMT73852-8	1/4" Repair Kit 5-25Nm	1/4"	50
STMT73853-8	3/8" Repair Kit 10-50Nm	3/8"	50
STMT74901-8	1/2" Repair Kit 20-100Nm	1/2"	50
STMT73854-8	1/2" Repair Kit 40-200Nm	1/2"	50
STMT74902-8	1/2" Repair Kit 60-340Nm	1/2"	50
STMT73855-8	3/4" Repair Kit 150-750Nm	3/4"	25



TORQUE WRENCH

STANLEY®

AIR TOOLS

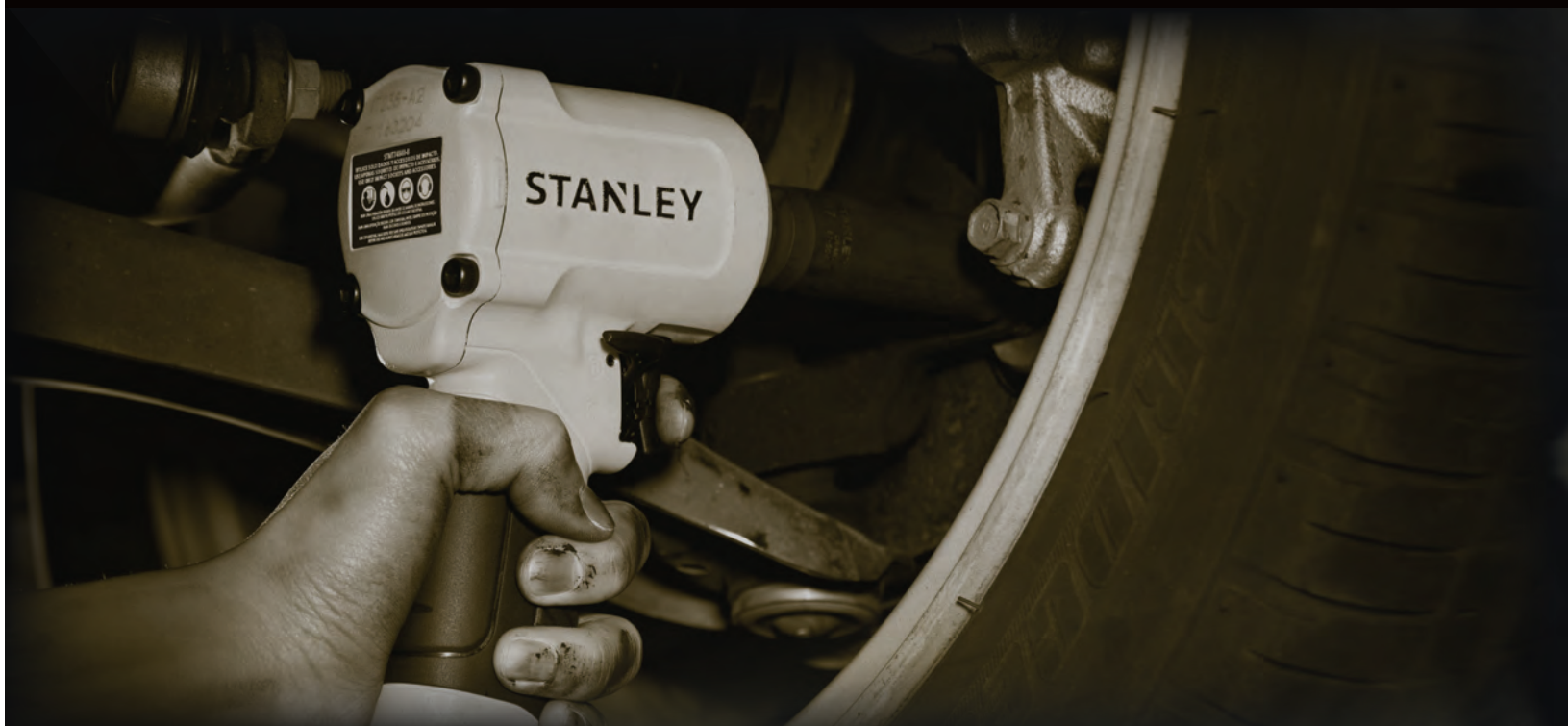

Impact Wrenches

Air Ratchets

Maintenance Kits



IMPACT WRENCHES AND AIR RATCHETS

CONTROLLED TORQUE FOR HEAVY JOBS

Featuring aluminium casings with heavy duty internal components, the **STANLEY®** Air tools range has been developed to offer speed, power and comfort.

Large switches for power adjustment and forward/ reverse make them fast and easy to use in all day long. Balanced design helps to keep the drive exactly where you need it, whilst durable clutch mechanisms avoid over-tightening.

Driver sizes of 3/8" up to 3/4" make them versatile enough for any workshop environment.

Used together with the **STANLEY®** Impact socket range they're the perfect solution to tough situations. With Air wrench and Air ratchet options available, they're flexible too.



“ I LIKE THE AIR RATCHETS COMPACT SIZE, IT'S GREAT FOR WORKING INSIDE DOORS OR ON TAILGATE STRUTS. ”

3/4"

AIR TOOL COMPARATOR

	SKU #	Drive Size	Max Torque		Free Speed (RPM)	Air Consumption (CFM)	Operating Pressure (PSI)	Vibration (m/s ²)	Noise Level dB (No Load)
			N-m	ft-lb					
IMPACT WRENCH	STMT70116-8	3/8"	244	180	9,000	3.1	90	3.0	86.0
	STMT99300-8	1/2"	610	450	7,500	3.9	90	5.20	95.0
	STMT97134-8	3/4"	1492	1100	3,600	4.0	90	5.50	96.2
	STMT74840-8	1/2"	678	500	10,000	5.3	90	9.77	95.9
AIR RATCHET	STMT78401-8	3/8"	81.4	60	180	3.9	90	3.73	88.5
	STMT78056-8	1/2"	81.4	60	180	3.9	90	3.73	88.5

1/2" MINI IMPACT WRENCH

NEW
 5000 RPM
 6500 RPM
 8500 RPM



- One hand rotation switch - forward/reverse for either left or right handed users
- Speed control – One hand operation with 3 positions disc switch
- Compact aluminium for better access in tight areas
- Durable jumbo hammer
- Ergonomic handle
- High working torque
- Durable and light weight
- Ergonomically engineered

1/2" DR.
678
 MAX TORQUE N.m

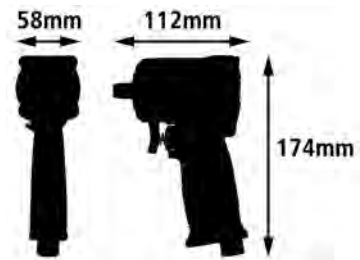

SKU #	Description	Anvil (inch)	Max Torque (N.m)	Free Speed (RPM)	Average Air Consumption (CFM)	Air Pressure (PSI)	Hose Size (inch)
STMT74840-8	1/2" Mini Impact Wrench	1/2"	678	10,000	5.3	90	3/8"

AIR TOOLS

1/2" IMPACT WRENCH REPAIR KIT

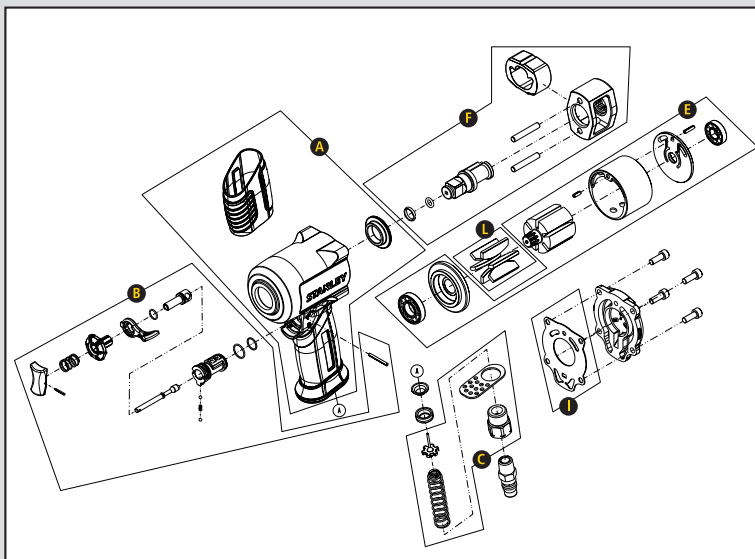

Serial No.	Parts No.	Description
A	12201-032U403-1	Housing repair kit
B	72AMPT2032003-1	Trigger set repair kit
C	72AMPT2032002-1	Air inlet repair kit
E	12202-0070073-1	Cylinder repair kit
F	72AMPT2032001-1	Hammer repair kit
I	12341-0324704-1	Gasket
L	72AMPT3032001-1	Rotor Blade

3/8" IMPACT WRENCH

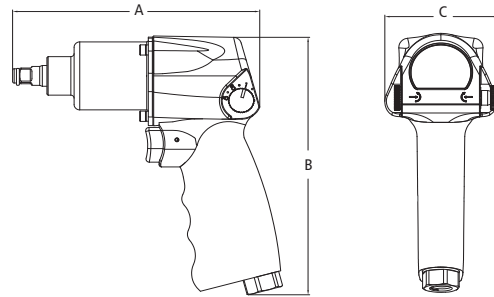

- 5 speeds forward and reverse
- Compact design for light torque applications
- Max Torque : 244 N-m (180 ft-lb)
- Free Speed : 9.000 RPM
- Air Consumption : 3.1 CFM
- Hammering Mechanism : jumbo hammer
- Vibration : 3.0 m/s²
- Noise level : 86.0 dB under no load
- Housing: alum.
- Exhaust: handle
- Air Pressure : 90 PSI
- Air Hose : 3/8"
- Air Inlet : 1/4"

3/8"DR.
244
MAX TORQUE N.m

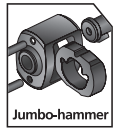

SKU #	Description	A (mm)	B (mm)	C (mm)	Weight (kg)
STMT70116-8	3/8" Impact Wrench 244 N-m (180 ft-lb)	154	168	71	1.27

3/8" IMPACT WRENCH REPAIR KIT

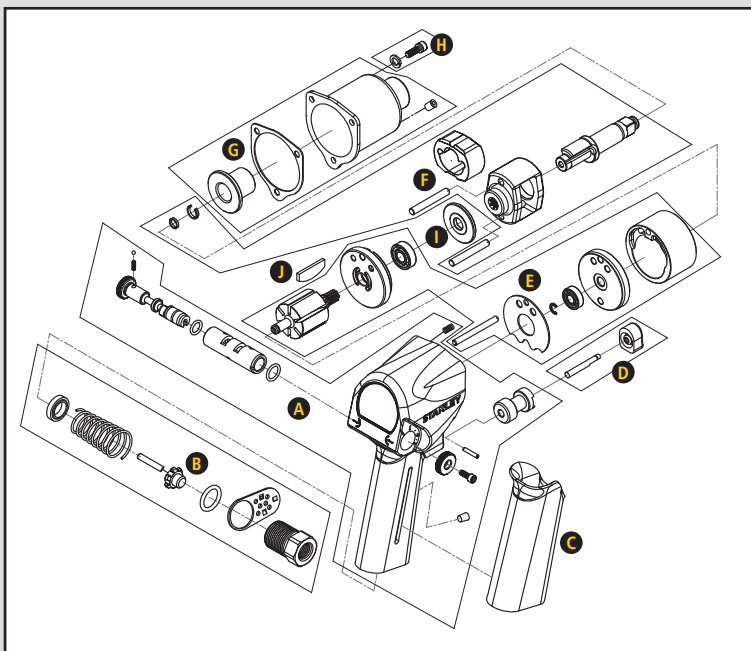

Serial No.	Parts No.	Description
A	K46301	Housing repair kit
B	K46008B	Air Inlet repair kit
C	46341	Handle Grip
D	K46009	Trigger set repair kit
E	K56313	Cylinder repair kit
F	K46333	Hammer repair kit
G	K46339	Front cover repair kit
H	K46340	Cap screw repair kit
I	46331	Washer
J	46327	Rotor Blade

1/2" IMPACT WRENCH

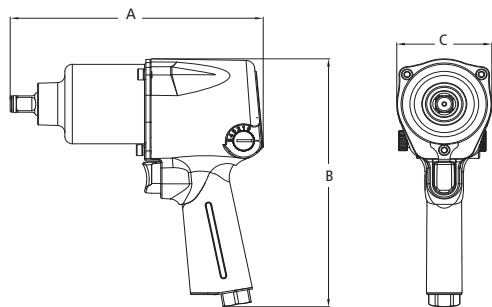

- Patented hammer case improving durability
- 5 speeds forward and reverse
- Balanced weight design and handle exhaust directs air away
- Max. Torque: 610 N-m (450 ft-lb)
- Free Speed: 7500 RPM
- Air Consumption: 3.9 CFM
- hammering mechanism : twin hammer
- Vibration: 5.20 m/s²
- Noise level: 95 dB under no load
- HOUSING: Alum.
- EXHAUST: Handle
- Air Pressure : 90 PSI
- Air hose : 3/8"
- Air Inlet : 1/4"

1/2"DR.
610
MAX TORQUE N.m

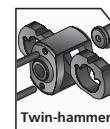

SKU #	Description	A (mm)	B (mm)	C (mm)	Weight (kg)
STMT99300-8	1/2" Impact Wrench 610 N-m (450 ft-lb)	187	193	70	2.58

1/2" IMPACT WRENCH REPAIR KIT

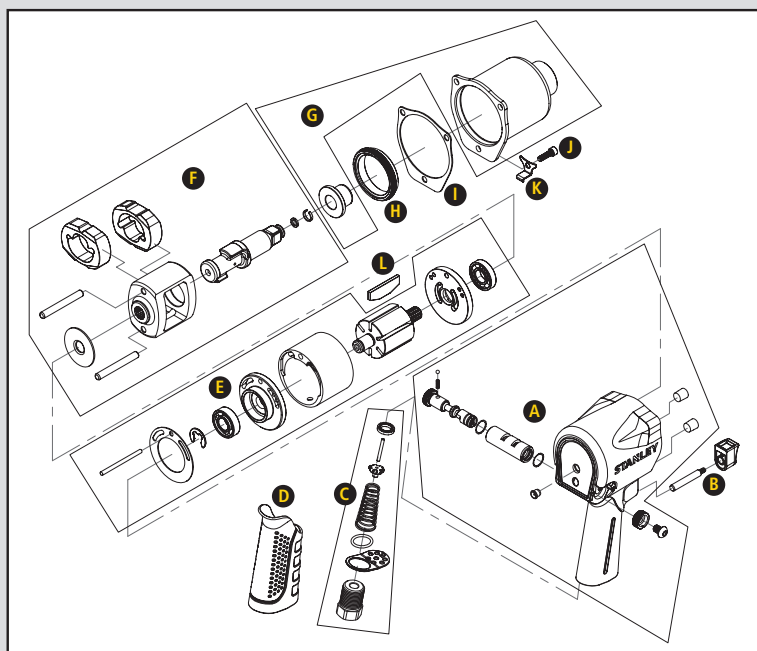

Serial No.	Parts No.	Description
A	K126001	Housing repair kit
B	K126011	Trigger set repair kit
C	K46008A	Air inlet repair kit
D	126042B	Handle grip
E	K126013	Cylinder repair kit
F	K106037	Hammer repair kit
G	K126039A	Front cover repair kit
H	116035	Hammer case pilot
I	126038	Gasket
J	16034	Screw
K	126040	Fixed plate
L	1260-25-A	Rotor Blade

3/4" IMPACT WRENCH

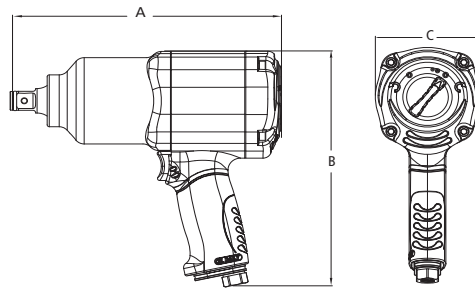

- High performance motor maximizes power output with full power in reverse; adjustable power in forward
- Balanced weight design and handle exhaust directs air away from the user
- Designed for fleet & truck service work
- Max. Torque: 1492 N-m (1.100 ft-lb)
- Free Speed: 3.600 RPM
- Air Consumption: 4.0 CFM
- Rotator: Pin Clutch
- Vibration: 5.50 m/s²
- Noise level: 96.2 under no load
- Housing: Alum.
- Exhaust: Handle
- Air Pressure : 90 PSI
- Air hose : 1/2"
- Air Inlet : 1/4"



SKU #	Description	A (mm)	B (mm)	C (mm)	Weight (kg)
STMT97134-8	3/4" Impact Wrench 1492 N-m (1.100 ft-lb)	259	263	99	5.72

3/4" IMPACT WRENCH REPAIR KIT

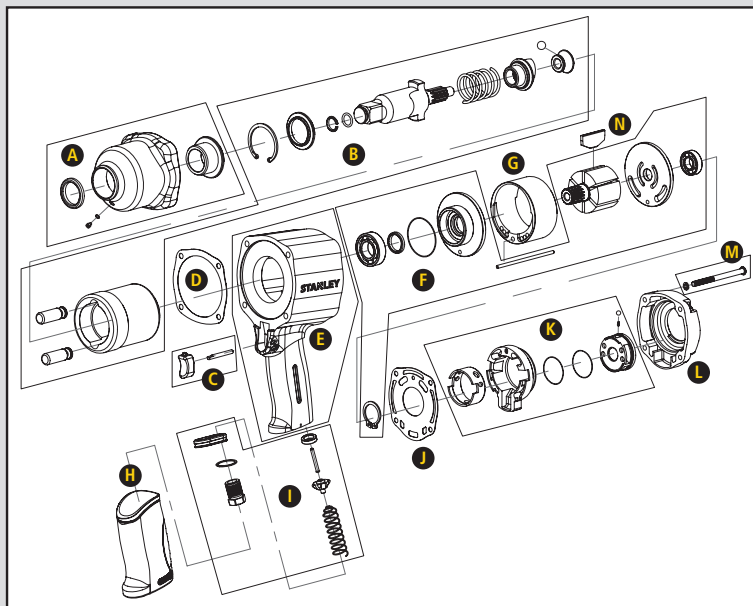

Serial No.	Parts No.	Description
A	K36144	Hammer Housing repair kit
B	K36122	Hammer Cage repair kit
C	K36104	Trigger repair kit
D	36131	Gasket
E	K36101	Housing repair kit
F	K36119	Rotor repair kit
G	36117	Cylinder
H	36147	Handle Grip
I	K36106	Valve Stem repair kit
J	36123	Gasket
K	K36128	Reverse Switch repair kit
L	36129	Rever Cover
M	36130/16126	Screw / Washer
N	36120	Rotor blade

3/8" AIR RATCHET

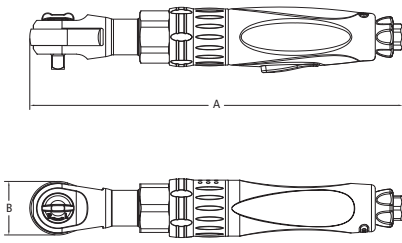

- Double ratchet pawls increase durability and tool life
- Enlarged forward and reverse switch
- Comfort rubber grip
- EXHAUST: 360° adjustable exhaust directs air away from the user
- Max. Torque: 81.4 N-m (60 ft-lb)
- Free Speed: 180 RPM
- Air Consumption: 3.9 CFM
- Rotator: Double Pawl
- Vibration: 3.73 m/s²
- Noise level: 88.50 dB under no load
- Air Pressure : 90 PSI
- Air hose : 3/8"
- Air Inlet : 1/4"



SKU #	Description	A (mm)	B (mm)	Weight (kg)
STMT78401-8	3/8" Air Ratchet 81.4 N-m (60 ft-lb)	278	41	1.22

3/8" AIR RATCHET REPAIR KIT

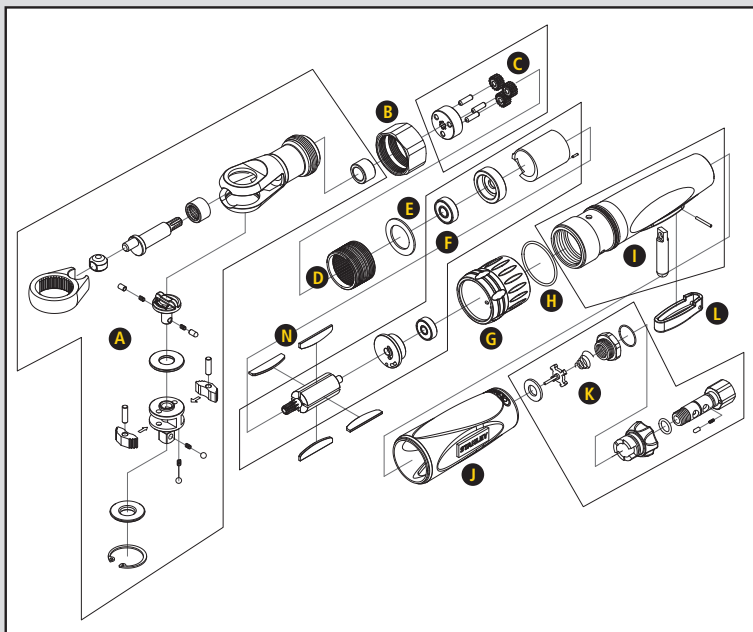

Serial No.	Parts No.	Description
A	K45021	Ratchet Housing repair kit
B	45015	Locking Nut
C	K15014	Gear repair kit
D	15012	Thread Ring Gear
E	45013	Washer
F	K15014	Cylinder repair kit
G	75020	Exhaust Deflector
H	45055	O-Ring
I	K75001	Housing repair kit
J	75018	Housing grip
K	K66024	Air Inlet repair kit
L	75003	Trigger
M	SF001	Repair tool for STMT78056-8 & STMT78401-8
N	15016	Rotor blade

1/2" AIR RATCHET

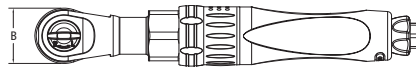
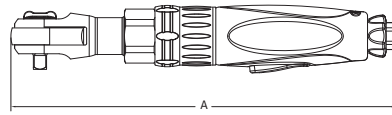

- Double ratchet pawls increase durability and tool life
- Enlarged forward and reverse switch
- Comfort rubber grip
- EXHAUST: 360° adjustable exhaust directs air away from the user
- Max. Torque: 81.4 N-m (60 ft-lb)
- Free Speed: 180 RPM
- Air Consumption: 3.9 CFM
- Rotator: Double Pawl
- Vibration: 3.73 m/s²
- Noise level: 88.50 dB under no load
- Air Pressure : 90 PSI
- Air hose : 3/8"
- Air Inlet : 1/4"

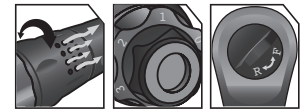

SKU #	Description	A (mm)	B (mm)	Weight (kg)
STMT78056-8	1/2" Air Ratchet 81.4 N-m (60 ft-lb)	278	41	1.22

1/2" AIR RATCHET REPAIR KIT

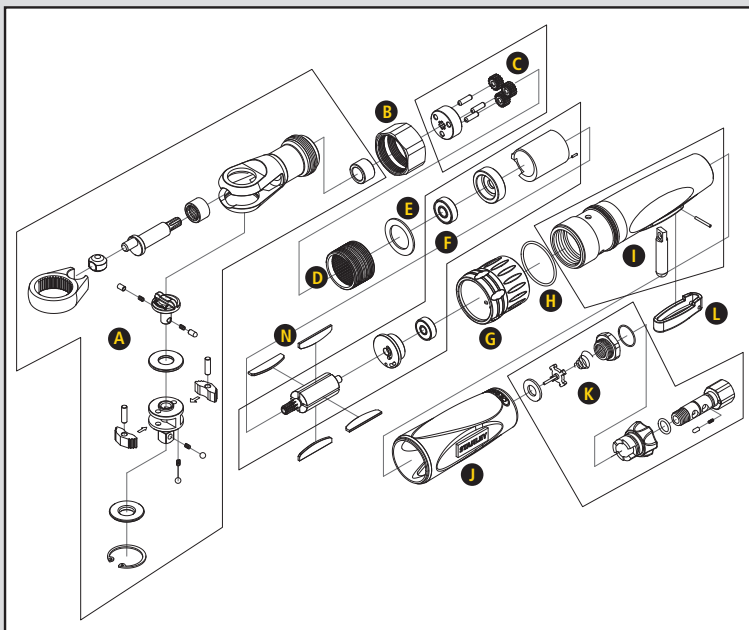

Serial No.	Parts No.	Description
A	K45021B	Ratchet Housing repair kit
B	45015	Locking Nut
C	K15014	Gear repair kit
D	15012	Thread Ring Gear
E	45013	Washer
F	K15014	Cylinder repair kit
G	75020	Exhaust Deflector
H	45055	O-Ring
I	K75001	Housing repair kit
J	75018	Housing grip
K	K66024	Air Inlet repair kit
L	75003	Trigger
M	SF001	Repair tool for STMT78056-8 & STMT78401-8
N	15016	Rotor blade



“ HERE’S A SMALL TIP TO MAXIMIZE YOUR AIR TOOL’S ENDURANCE: SLATHER A TEASPOON OF COOKING OIL IN THE AIR INLET ONCE IN A WHILE. THIS ENSURES THE MECHANISM IS WELL LUBRICATED AND THE TORQUE OUTPUT REMAINS CONSISTENT. THERE IS ALWAYS MOISTURE FORMING IN THE AIR PIPELINES OF ALL WORKSHOP ”

SERVICE & SUPPORT

Our success is heavily dependent on yours, along with our distribution network, we can and will remain dedicated to the maintenance and development of this tool range, providing the very best solutions for our customers.

Please contact our local service center representatives for air tool maintenance training materials.



STANLEY®

SPECIALTY TOOLS & ACCESSORIES



Feeler Guage

AC/Fuel Line Disconnect Set

Round Inspection Mirror

Magnetic Pick Up Tool

Oil Filter Wrench

Lever Action Grease Gun

Cross Wrench



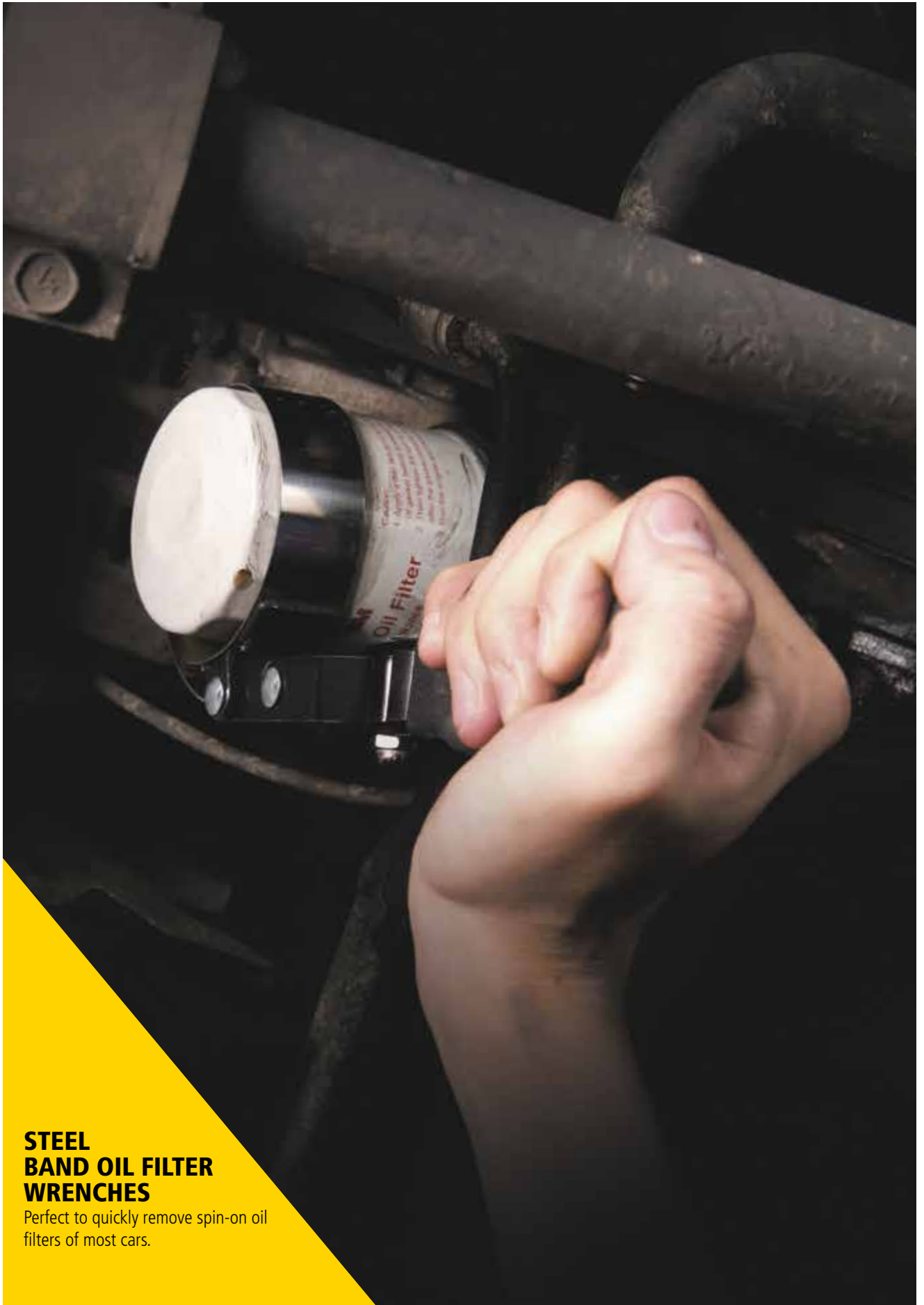

**STEEL
BAND OIL FILTER
WRENCHES**

Perfect to quickly remove spin-on oil filters of most cars.

COMBINATION FEELER GAUGE 32/36 BLADES (65MN)



- For gauging and adjusting spacing between parts such as valve clearances, spark plug gaps and distributor points
- Hardened and tempered steel blades
- Each blade marked with SAE and metric sizes
- Lock nut holds blades in desired position

SKU #	Description	Feeler Blades	Size	Box Qty
STMT78221-8	Combination Feeler Gauge 32Blades (65Mn)	32	Magnetic (Inch) 0.010 Magnetic (MM) 0.254 Non-Magnetic (Inch) 0.0015, 0.002, 0.0025, 0.003, 0.004, 0.005, 0.006, 0.007, 0.008, 0.009, 0.010, 0.011, 0.012, 0.013, 0.014, 0.015, 0.016, 0.017, 0.018, 0.019, 0.020, 0.022, 0.023, 0.024, 0.025, 0.026, 0.028, 0.030, 0.032, 0.035 Non-Magnetic (MM) 0.038, 0.051, 0.063, 0.076, 0.102, 0.127, 0.152, 0.178, 0.203, 0.229, 0.254, 0.279, 0.305, 0.330, 0.356, 0.381, 0.406, 0.432, 0.457, 0.483, 0.508, 0.559, 0.584, 0.610, 0.635, 0.711, 0.762, 0.813, 0.889	6
STMT78214-8	Combination Feeler Gauge 36Blades (65Mn)	36	Magnetic (Inch) 0.002, 0.0025, 0.003, 0.004, 0.005, 0.006, 0.007, 0.008, 0.009, 0.010, 0.011, 0.012, 0.013, 0.014, 0.015, 0.016, 0.017, 0.018, 0.019, 0.020, 0.021, 0.022, 0.023, 0.024, 0.025, 0.026, 0.028, 0.030, 0.032, 0.035 Magnetic (MM) 0.051, 0.063, 0.076, 0.102, 0.127, 0.152, 0.178, 0.203, 0.229, 0.254, 0.279, 0.305, 0.330, 0.356, 0.381, 0.406, 0.432, 0.457, 0.483, 0.508, 0.533, 0.559, 0.584, 0.610, 0.635, 0.660, 0.711, 0.762, 0.813, 0.889 Non-Magnetic (Inch) 0.006, 0.008, 0.010, 0.012, 0.014, 0.016 Non-Magnetic (MM) 0.152, 0.203, 0.254, 0.305, 0.356, 0.406	6

AC/FUEL LINE DISCONNECT SET 7 SIZES



- Easily disconnects air conditioning lines and fuel lines
- ABS plastic construction

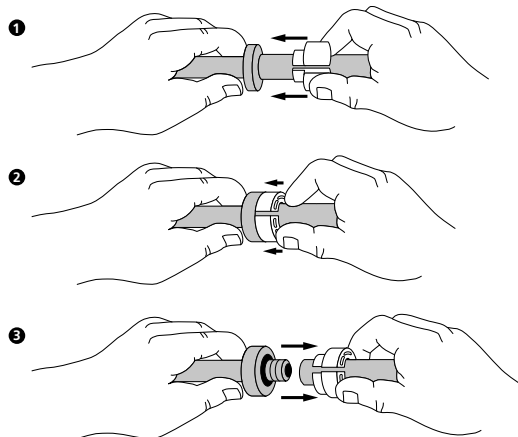

SKU #	Description	Size	Box Qty
STMT90062-8	AC/Fuel Line Disconnect Set 7 Sizes	1/4", 5/16", 3/8", 1/2", 5/8", 3/4", 7/8"	24

ROUND INSPECTION MIRROR



- Allows visibility in confined areas
- Double ball joint allows extreme mirror angles along with 360° swivel

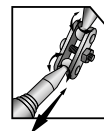

SKU #	Description	Diameter		Range		Box Qty
STMT78241-8	Round Inspection Mirror	57 mm	2-1/4 in	299-464 mm	11-3/4 - 18-1/4 in	24

MAGNETIC PICK UP TOOL



- Flexible shaft holds any angle
- Will magnetize to any iron or steel object
- Great for picking up fasteners that fall into tight spaces



SKU #	Description	Length	Box Qty
STMT78020-8	Magnetic Pick Up Tool	600 mm	10

OIL FILTER WRENCH



- Specially designed to remove and install oil filters
- With stainless steel band

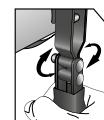

SKU #	Description	Size	Box Qty
STMT78228-8	Oil Filter Wrench 73-83mm	73-83 mm, (2-7/8 - 3-1/4 ")	6
STMT78229-8	Oil Filter Wrench 89-98mm	89-98mm, (3-1/2 - 3-7/8 ")	6

LEVER ACTION GREASE GUN



- Precision-fitted and hardened plunger prevents lubricant escape from cartridge
- Extra-long handle for increased leverage and easy operation
- Rugged cast pump head for strength and durability and tough impact resistant construction
- Use standard grease cartridge or can be used for bulk fill
- High volume operation
- Non-slip grip handle
- 12000PSU pressure
- Easy to operate
- Heavy duty

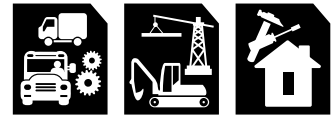

SKU #	Description	Volume		Length		Box/CTN
95-385-IV	Lever Action Grease Gun	400 gr	14 oz	150 mm	16 in	6/24

CROSS WRENCH



- Chrome Vanadium Steel
- Cross type structure
- Convenient operation
- Greater torque
- Labor-saving



SKU #	Description	Size	Box Qty
STMT94030-8	Cross Wrench	17, 19, 21, 23mm	2

PRODUCT INDEX

ALPHA NUMERIC

SKU #	Page
0-10-018	116
0-10-480	115
0-11-983	121
0-12-312	210
02-110	155
02-112	155
02-130	155
0-29-086	208
0-29-256	208
0-29-277	208
0-77-030N	57
10-065	118
10-099	117
10-131-S	118
10-143-S	118
10-280-0	116
10-380-0	119
10-777	120
1-12-020	210
1-12-060	210
1-12-102	211
11-301T	120
11-921H	120
11-921T	120
11-987	121
1-29-045	208
1-29-069	208
1-29-076	208
1-29-494	208
14-163	131
14-164	131
14-165	131
14-166	131
14-302	129
14-303	129
14-308-S	129
14-312-S	129
14-314-S	129
14-318-S	129
14-324-S	129
14-330-S	129
14-336-S	129
1-43-524	79

SKU #	Page
14-442	128
14-562	130
14-563	130
14-564	130
14-566	130
15-166	122
15-265-S	122
15-565-S	122
15-982-23	127
15-988	127
16-276	201
16-279	201
16-282	201
16-285	201
16-329	202
16-332	202
1-70-353	95
1-71-948	99
1-71-949	99
1-71-950	99
1-71-951	99
1-77-022	58
1-77-023	58
1-77-160	48
1-77-171	58
1-77-174	55
1-77-201	58
1-77-245	48
1-77-319	52
1-77-320	50
1-77-321	50
1-77-429	49
1-92-749	100
1-92-904	93
1-93-935	94
1-94-210	92
1-94-749	94
1-94-850	92
1-96-179	102
1-97-512	97
1-97-514	97
1-97-515	105
20-004-23	123

SKU #	Page
20-005-23	123
20-006-23	123
20-007-23	123
20-081	123
20-082-23	123
20-083-23	123
20-175	127
20-176	127
20-177	127
20-331	123
20-500	124
20-502	122
20-503	122
20-556	123
22-078H	209
22-082B	209
22-083B	209
22-087B	209
22-090	209
22-091	209
22-096	210
22-096B	210
22-172	210
22-173B	210
22-187	209
22-223	209
22-224	209
22-225	209
22-226	209
22-227	209
22-233	210
22-234	210
22-304	209
22-304B	209
22-305	209
22-305B	209
22-306	209
2-29-078	208
29-030-1	208
29-035-1	208
30-608L	68
30-611L	68
34-777	70

SKU #	Page
35-344	71
35-345	71
35-346	71
35-347	71
35-348	71
42-244	79
43-525	79
43-536	79
43-537	79
43-548	79
43-549	79
43-553	80
43-554	80
43-555	80
43-556	80
43-557	80
43-558	80
45-500	81
45-530	81
45-600	81
46-012	82
46-028	82
46-825-0	82
47-460	83
5-21-102	211
5-21-103	211
5-21-104	211
5-21-115	212
5-21-293	213
5-21-299	213
5-21-393	213
5-21-398	213
5-21-508	213
5-21-515	213
54-192	197
54-193	197
55-113	200
55-114	200
55-115	200
55-118	199
55-150	200
56-202	196
56-204	196

SKU #	Page
56-803	197
56-804	197
56-808	197
56-812	197
56-816	197
57-530	198
57-531	198
57-532	198
57-533	198
57-534	198
58-911	203
63-013T-23	179
63-014T-23	179
63-015T-23	179
63-016T-23	179
63-026T-23	179
63-027T-23	179
63-028T-23	179
63-029T-23	179
63-054T-23	179
63-055T-23	179
63-056T-23	179
63-057T-23	179
63-101T-23	180
63-102T-23	180
63-103T-23	180
63-104T-23	180
63-105T-23	180
63-106T-23	180
63-107T-23	180
63-108T-23	180
63-111F-23	180
63-112F-23	180
63-113F-23	180
63-189-23	181
66-119-S	173
66-120-S	173
66-133	173
66-137-S	173
69-031B	189
69-031C	189
69-033B	189
69-033C	189

SKU #	Page
69-041B	189
69-041C	189
69-119	185
69-213	185
69-230	185
69-251	185
69-252	185
69-253	185
69-254	185
69-256	185
69-257	185
69-259	185
69-260	185
69-261	185
69-262	185
69-263	185
69-GR10B	187
69-GR10C	187
69-GR15B	187
69-GR15C	187
69-GR20B	188
69-GR20C	188
69-GR25B	188
69-GR25C	188
69-GR90B	188
69-GR90C	188
79-064-S	231
79-065-S	231
79-066-S	231
79-067	231
79-068-S	231
79-069-S	231
79-070-S	231
79-071	231
79-072	231
79-073	231
79-074	231
79-075	231
81-600-1	155
81-601-1	155
81-602-1	155
81-603-1	155
81-604-1	155

SKU #	Page
81-605-1	155
83-033K	181
83-034K	181
83-035K	181
83-036K	181
84-000	154
84-001	154
84-002	154
84-004	154
84-006	154
84-007	154
84-009	154
84-010	154
84-011	154
84-016	154
84-168	154
84-214	129
84-223	154
84-253	154
84-258	129
84-629	129
84-630	129
84-632	129
84-758	231
84-759	231
84-760	231
84-764	231
84-765	231
84-766	231
84-767	231
86-012-1	247
86-0430	232
86-0432	232
86-0436	232
86-213-1	247
86-405-1	247
86-413-1	247
86-415-1	247
86-477	245
86-477	246
86-478	244
86-589-1	246
87-011-1	224

SKU #	Page
87-033-1	223
87-034-1	223
87-036-1	223
87-038-1	223
87-057	230
87-058	230
87-066	230
87-069	230
87-070-1	230
87-071-1	230
87-072-1	230
87-073-1	230
87-074-1	230
87-075-1	230
87-076-1	230
87-077-1	230
87-078-1	230
87-079-1	230
87-080-1	230
87-081-1	230
87-082-1	230
87-083-1	230
87-084-1	230
87-085-1	230
87-086-1	230
87-087-1	230
87-088-1	230
87-089-1	230
87-090-1	230
87-092-1	230
87-096-1	231
87-097-1	231
87-098-1	231
87-099-1	231
87-100-1	231
87-101-1	231
87-102-1	231
87-103-1	231
87-104-1	231
87-105-1	231
87-106-1	231
87-107-1	231
87-264	230

PRODUCT INDEX

ALPHA NUMERIC

SKU #	Page
87-265	230
87-266	230
87-268	230
87-271	230
87-272	230
87-276	230
87-278	230
87-280	230
87-424-1	230
87-429-1	230
87-430-1-S	234
87-617-1	224
87-620-S	155
87-621-S	155
87-622-S	155
87-623-S	155
87-624-S	155
87-625-S	155
87-626-S	155
87-627-S	155
87-629-23	155
87-660-1	230
87-661-1	230
87-662-1	230
87-663-1	230
87-664-1	230
87-665-1	230
87-666-1	230
87-667-1	230
87-668-1	230
87-669-1	230
87-670-1	230
87-671-1	230
87-672-1	230
87-673-1	230
87-674-1	230
87-675-1	230
87-676-1	231
87-677-1	231
87-678-1	231
87-679-1	231
87-680-1	231
87-681-1	231

SKU #	Page
87-682-1	231
87-683-1	231
87-684-1	231
87-685-1	231
87-686-1	231
87-705-1	231
87-706-1	231
87-709-1	223
87-710	247
87-715	247
87-718-1	224
87-720	247
89-033	244
89-035-1	244
89-092-1	245
89-101-1	245
89-302-1	247
89-507	245
89-509	246
89-518	244
90-596N	106
90-597	106
92-006	106
93-020	128
93-021	128
93-028	128
93-033	128
95-294-23	127
95-295-23	127
95-296-23	127
95-297-23	127
95-298-23	127
95-299-23	127
95-385-IV	333
FMHT0-77407	57
FMHT1-77441	49
FMST1-71181	103
FMST1-71219	96
FMST514196	105
SC121	21
SC201	21
SCB12S	21
SCB20C	21

SKU #	Page
SCD12S2	16
SCD20C2	16
SCDI12S2	20
SCH12S2	18
SCH20C2	18
SCI12S2	17
SDH600	12
SDH700	12
SDR1400	13
SDR3006	11
SSS310	38
STA0414	26
STA0415	26
STA4500	26
STA4502A	26
STA4503A	26
STA4510	26
STA4520	26
STA4520FA	26
STA4522	26
STA4522FA	26
STA4523	26
STA4523FA	26
STA4524	26
STA4524FA	26
STA47122L	32
STA47142L	32
STA47400B	32
STA47400L	32
STA47401B	32
STA47401L	32
STA47402B	32
STA47402L	32
STA47450L	32
STA47451L	32
STA47452L	32
STA47700L	32
STA47701L	32
STA47702L	32
STA47900L	32
STA47901L	32
STA47902L	32
STA50004B10	14

SKU #	Page
STA50009B10	14
STA50014B10	14
STA50024B10	14
STA50029B10	14
STA50034B10	14
STA50039B10	14
STA50044B10	14
STA50059B10	14
STA50069B10	14
STA50074B10	14
STA50079B10	14
STA50089B10	14
STA50094B10	14
STA50099B10	14
STA50104B05	14
STA50109B05	14
STA50119B05	14
STA50124B05	14
STA50134B05	14
STA50139B05	14
STA50144B05	14
STA50149B05	14
STA50154B05	14
STA50159B05	14
STA50164B05	14
STA53030C	14
STA53040C	14
STA53050C	14
STA53060C	14
STA53065C	14
STA53070C	14
STA53080C	14
STA53090C	14
STA53110C	14
STA53111C	14
STA53112C	14
STA53113C	14
STA53114C	14
STA53116C	14
STA53118C	14
STA53120C	14
STA54002	35
STA54012	35

SKU #	Page
STA54022	35
STA54027	35
STA54032	35
STA54037	35
STA54042	35
STA54047	35
STA54050C	14
STA54052	35
STA54057	35
STA54060C	14
STA54062	35
STA54065C	14
STA54067	35
STA54072	35
STA54077	35
STA54080C	14
STA54087	35
STA54095C	14
STA54097	35
STA54102	35
STA54107	35
STA54112	35
STA54117	35
STA54122	35
STA54127	35
STA54132	35
STA54137	35
STA54152	35
STA54227	35
STA54237	35
STA54282	35
STA54401	34
STA54406	34
STA54411	34
STA54416	34
STA54421	34
STA54426	34
STA54431	34
STA54436	34
STA54441	34
STA54446	34
STA54451	34
STA54456	34

SKU #	Page
STA54466	34
STA54476	34
STA54481	34
STA54496	34
STA54501	34
STA56065C	14
STA56080C	14
STA56100C	14
STA56130C	14
STA56160C	14
STA56200C	14
STA7717	38
STA7737	38
STA7740	38
STA7747	38
STA7757	38
STA7770	38
STA8011R	26
STA8012R	26
STA8050	26
STA8060	26
STBL182L	21
STBL184L	21
STBT18L	21
STCD1842K	20
STCD1843K	21
STCI1800	17
STCI1802	18
STCT1810	19
STCT1820	19
STCT1830	19
STCT1840	19
STCT1850	20
STCT1860	20
STCT1872/1874	18
STDC1800	16
STDC1802	17
STDC411LB	16
STDC441LB	17
STDH7213	12
STDH7213V	13
STDR5206	11
STDR5510	12

SKU #	Page
STEL101	11
STEL201	11
STEL311	37
STEL345	37
STEL365	37
STEL501K	29
STEL503K	29
STEL505K	29
STEL506K	30
STEL630	39
STEL670	39
STEL680	39
STEL701	25
STEL721	37
STEL861	25
STGL2018	25
STGL2023	25
STGL2218	24
STGL2223	24
STGS5100	23
STGS6100	23
STGS7100	23
STGS8100	24
STGT5100	23
STGT7100	24
STGT8100	24
STHM10K	31
STHM5KH	30
STHR202K	29
STHR271K	30
STHR272K	30
STHT10150-8	114
STHT10151-8	114
STHT10175-8	117
STHT10189-8	118
STHT10209-8	116
STHT10264-8	114
STHT10265-8	114
STHT10266-8	114
STHT10268-8	114
STHT10409-8	115
STHT10418-8	115
STHT10425-8	115

SKU #	Page
STHT10779-8	117
STHT11147-8Q	121
STHT11300-8	120
STHT11300-8Q	120
STHT11301-8	120
STHT11301-8Q	120
STHT11325-8	120
STHT11325-8Q	120
STHT11921-8	121
STHT11921-8Q	121
STHT14556-8	131
STHT14558-8	131
STHT14569-8	131
STHT15104-8	124
STHT15106-8	124
STHT15200-8	126
STHT15555-8	126
STHT15809-8	124
STHT16089-8	202
STHT16107-8	203
STHT16111-8	203
STHT16115-8	203
STHT16120-8	203
STHT16289-8	202
STHT16290-8	202
STHT16298-8	203
STHT1-77032	53
STHT1-77137	51
STHT1-77138	53
STHT1-77139	54
STHT1-77140	55
STHT1-77340	51
STHT1-77341	52
STHT1-77343	54
STHT20064-8	125
STHT20138	124
STHT20140-8	125
STHT20206-8	125
STHT20297-8	126
STHT20298-8	126
STHT20299-8	126
STHT20807-8	124
STHT30204-8	69

PRODUCT INDEX

ALPHA NUMERIC

SKU #	Page
STHT30456-8	69
STHT30457-8	69
STHT30486-8	69
STHT30487-8	69
STHT30496-31L	69
STHT30496-8	69
STHT30497-8	69
STHT30504-8	67
STHT30505-8	67
STHT30506-8	67
STHT30507-8	67
STHT30508-8	67
STHT30509-8	67
STHT30510-8	67
STHT30511-8	67
STHT30656-8	68
STHT30686-8	68
STHT30696-8	68
STHT33158-8	67
STHT33203-8	67
STHT33215-8	67
STHT33428-8	67
STHT33463-8	67
STHT33492-8	69
STHT33493-8	69
STHT33650-8	225
STHT33989-8	69
STHT33994-8	69
STHT34104-8	71
STHT34107-8	71
STHT34260-8	70
STHT34262-8	70
STHT34263-8	70
STHT34296-8	70
STHT34298-8	70
STHT34791-8	70
STHT34794-8	70
STHT42072-8	80
STHT42073-8	80
STHT42074-8	80
STHT42075-8	80
STHT42076-8	80
STHT42264-8	77

SKU #	Page
STHT42291-8	77
STHT42465-8	77
STHT42467-8	79
STHT42468-8	79
STHT42470-8	79
STHT42521-8	78
STHT42522-8	78
STHT42523-8	78
STHT43102-8	78
STHT43103-8	78
STHT43104-8	78
STHT43105-8	78
STHT43106-8	78
STHT43107-8	78
STHT43108-8	78
STHT43109-8	78
STHT43118-8	78
STHT43511-8	77
STHT46530-8	80
STHT46532-8	80
STHT46534-8	80
STHT46536-8	80
STHT47403-8	83
STHT47404-8	83
STHT47440-8	83
STHT47442-8	83
STHT47443-8	83
STHT51071-8	196
STHT51072-8	196
STHT51081-8	196
STHT51082-8	196
STHT51112-8	196
STHT51265-8	195
STHT51269-8	195
STHT51271-8	195
STHT51274-8	195
STHT54189-8	197
STHT54190-8	197
STHT54191-8	197
STHT55124-8	199
STHT55130-8	199
STHT55136-8	199
STHT57055-8	198

SKU #	Page
STHT57056-8	198
STHT57057-8	198
STHT57516-8	198
STHT57523-8	198
STHT57527-8	198
STHT57528-8	198
STHT62508-8	176
STHT62511-8	176
STHT65144-8	164
STHT65144-8B	164
STHT65145-8	164
STHT65145-8B	164
STHT65146-8	164
STHT65146-8B	164
STHT65147-8	164
STHT65147-8B	164
STHT65148-8	164
STHT65148-8B	164
STHT65149-8	164
STHT65149-8B	164
STHT65150-8	164
STHT65150-8B	164
STHT65151-8	164
STHT65151-8B	164
STHT65152-8	164
STHT65152-8B	164
STHT65153-8	164
STHT65153-8B	164
STHT65154-8	164
STHT65154-8B	164
STHT65155-8	166
STHT65156-8	167
STHT65157-8	162
STHT65157-8B	162
STHT65158-8	162
STHT65158-8B	162
STHT65159-8	162
STHT65159-8B	162
STHT65160-8	162
STHT65160-8B	162
STHT65162-8	162
STHT65162-8B	162
STHT65163-8	162

SKU #	Page
STHT65163-8B	162
STHT65164-8	162
STHT65164-8B	162
STHT65165-8	162
STHT65165-8B	162
STHT65166-8	162
STHT65166-8B	162
STHT65167-8	162
STHT65167-8B	162
STHT65168-8	162
STHT65168-8B	162
STHT65169-8	162
STHT65169-8B	162
STHT65170-8	162
STHT65170-8B	162
STHT65171-8	162
STHT65171-8B	162
STHT65172-8	162
STHT65172-8B	162
STHT65173-8	162
STHT65173-8B	162
STHT65174-8	162
STHT65174-8B	162
STHT65180-8	163
STHT65180-8B	163
STHT65181-8	163
STHT65181-8B	163
STHT65182-8	163
STHT65182-8B	163
STHT65183-8	163
STHT65183-8B	163
STHT65186-8	163
STHT65186-8B	163
STHT65187-8	163
STHT65187-8B	163
STHT65188-8	163
STHT65188-8B	163
STHT65189-8	163
STHT65189-8B	163
STHT65190-8	163
STHT65190-8B	163
STHT65191-8	163
STHT65191-8B	163

SKU #	Page
STHT65192-8	163
STHT65192-8B	163
STHT65193-8	163
STHT65193-8B	163
STHT65194-8	163
STHT65194-8B	163
STHT65195-8	163
STHT65195-8B	163
STHT65196-8	163
STHT65196-8B	163
STHT65197-8	163
STHT65197-8B	163
STHT65198-8	163
STHT65198-8B	163
STHT65199-8	166
STHT65200-8	166
STHT65227-8	164
STHT65227-8B	164
STHT65228-8	164
STHT65228-8B	164
STHT65229-8	164
STHT65229-8B	164
STHT65242-8	165
STHT65966-8	172
STHT65967-8	172
STHT65968-8	172
STHT65969-8	172
STHT65970-8	172
STHT65971-8	172
STHT65972-8	172
STHT65973-8	172
STHT65974-8	172
STHT65975-8	172
STHT65980-8	172
STHT66039-8	177
STHT66052-8	177
STHT66357-8	175
STHT66358-8	175
STHT68010-8	174
STHT68012-8	174
STHT69101-8	170
STHT69101-8B	170
STHT69102-8	170

SKU #	Page
STHT69102-8B	170
STHT69103-8	170
STHT69103-8B	170
STHT69104-8	170
STHT69104-8B	170
STHT69106-8	170
STHT69106-8B	170
STHT69107-8	170
STHT69107-8B	170
STHT69108-8	170
STHT69108-8B	170
STHT69109-8	170
STHT69109-8B	170
STHT69111-8	170
STHT69111-8B	170
STHT69112-8	170
STHT69112-8B	170
STHT69113-8	170
STHT69113-8B	170
STHT69114-8	170
STHT69114-8B	170
STHT69116-8	170
STHT69116-8B	170
STHT69118-8	170
STHT69118-8B	170
STHT69119-8B	170
STHT69120-8B	170
STHT69121-8	170
STHT69121-8B	170
STHT69138-8	169
STHT69138-8B	169
STHT69139-8	169
STHT69139-8B	169
STHT69141-8	169
STHT69141-8B	169
STHT69142-8	169
STHT69142-8B	169
STHT69144-8	169
STHT69144-8B	169
STHT69145-8	169
STHT69145-8B	169
STHT69146-8	169
STHT69146-8B	169

SKU #	Page
STHT69147-8	169
STHT69147-8B	169
STHT69148-8	169
STHT69148-8B	169
STHT69150-8	169
STHT69162-8	171
STHT69163-8	171
STHT69164-8	171
STHT69166-8	171
STHT69167-8	171
STHT69168-8	171
STHT69175-8	170
STHT69175-8B	170
STHT69177-8	169
STHT69177-8B	169
STHT69178-8	169
STHT69178-8B	169
STHT69179-8	169
STHT69179-8B	169
STHT69180-8	169
STHT69180-8B	169
STHT69646-8	189
STHT69800-8	189
STHT70487-8	142
STHT72678-8L	181
STHT72679-8L	181
STHT72680-8L	181
STHT72681-8L	181
STHT72991-8	173
STHT72991-8B	173
STHT72992-8	173
STHT72992-8B	173
STHT73655-8	153
STHT74995-8	131
STHT84021-8	140
STHT84024-8	140
STHT84026-8	140
STHT84027-8	138
STHT84028-8	138
STHT84029-8	138
STHT84031-8	137
STHT84032-8	137
STHT84034-8	140

SKU #	Page
STHT84035-8	138
STHT84053-8	137
STHT84055-8	140
STHT84071-8	139
STHT84072-8	139
STHT84073-8	141
STHT84074-8	141
STHT84075-8	142
STHT84077-8	139
STHT84096-8	147
STHT84097-8	146
STHT84098-8	146
STHT84100-8	143
STHT84101-8	143
STHT84102-8	143
STHT84104-8	144
STHT84105-8	144
STHT84108-8	144
STHT84110-8	146
STHT84112-8	143
STHT84113-8	143
STHT84119-8	143
STHT84122-8	147
STHT84124-8	144
STHT84125-8	145
STHT84126-8	145
STHT84167-8	139
STHT84221-8	148
STHT84222-8	143
STHT84258-8	144
STHT84271-8	148
STHT84272-8	148
STHT84273-8	148
STHT84274-8	148
STHT84368-8	150
STHT84369-8	150
STHT84370-8	150
STHT84371-8	150
STHT84378-8	149
STHT84379-8	149
STHT84389-8	149
STHT84396-8	150
STHT84397-8	151

PRODUCT INDEX

ALPHA NUMERIC

SKU #	Page
STHT84398-8	151
STHT84399-8	151
STHT84607-8	138
STHT84609-8	138
STHT84623-8	138
STHT84900-8	137
STHT90162-8	152
STHT90163-8	152
STHT90164-8	152
STHT91526-8	152
STHT92002-8	165
STHT92004-8	165
STMT69213-8	185
STMT70116-8	322
STMT72793-8	243
STMT72794-8	243
STMT72795-8	269
STMT72803-8	229
STMT72803-8B	229
STMT72804-8	229
STMT72805-8	229
STMT72805-8B	229
STMT72806-8	229
STMT72806-8B	229
STMT72807-8	229
STMT72807-8B	229
STMT72808-8	229
STMT72808-8B	229
STMT72809-8	229
STMT72809-8B	229
STMT72810-8	229
STMT72810-8B	229
STMT72811-8	229
STMT72811-8B	229
STMT72812-8	229
STMT72812-8B	229
STMT72813-8	229
STMT72813-8B	229
STMT72814-8	229
STMT72814-8B	229
STMT72815-8	229
STMT72815-8B	229
STMT72816-8	229

SKU #	Page
STMT72816-8B	229
STMT72817-8	229
STMT72817-8B	229
STMT72818-8	229
STMT72818-8B	229
STMT72819-8	229
STMT72819-8B	229
STMT72820-8	229
STMT72820-8B	229
STMT72821-8	229
STMT72821-8B	229
STMT72822-8B	229
STMT72823-8B	229
STMT72824-8B	229
STMT72825-8B	229
STMT72826-8B	229
STMT72827-8B	229
STMT72828-8B	229
STMT72837-8	232
STMT72837-8B	232
STMT72838-8	232
STMT72838-8B	232
STMT72839-8	232
STMT72839-8B	232
STMT72840-8	232
STMT72840-8B	232
STMT72841-8	232
STMT72841-8B	232
STMT72842-8	232
STMT72842-8B	232
STMT72843-8	232
STMT72843-8B	232
STMT72844-8	232
STMT72844-8B	232
STMT72845-8	232
STMT72845-8B	232
STMT72846-8	232
STMT72846-8B	232
STMT72847-8	232
STMT72847-8B	232
STMT72848-8	232
STMT72848-8B	232
STMT72849-8	232

SKU #	Page
STMT72849-8B	232
STMT72850-8	232
STMT72850-8B	232
STMT72851-8	232
STMT72851-8B	232
STMT72852-8	232
STMT72852-8B	232
STMT72853-8	232
STMT72853-8B	232
STMT72854-8B	232
STMT72856-8B	232
STMT72857-8	233
STMT72857-8B	233
STMT72858-8	233
STMT72858-8B	233
STMT72859-8	233
STMT72859-8B	233
STMT72860-8	233
STMT72860-8B	233
STMT72861-8	233
STMT72861-8B	233
STMT72862-8	233
STMT72862-8B	233
STMT72863-8	233
STMT72863-8B	233
STMT72864-8	233
STMT72864-8B	233
STMT72865-8	233
STMT72865-8B	233
STMT72866-8	233
STMT72866-8B	233
STMT72867-8	233
STMT72867-8B	233
STMT72868-8	233
STMT72868-8B	233
STMT72869-8	233
STMT72869-8B	233
STMT72870-8B	233
STMT72872-8B	252
STMT72873-8B	252
STMT72874-8B	252
STMT72875-8B	252
STMT72876-8B	252

SKU #	Page
STMT72877-8B	252
STMT72878-8B	252
STMT72879-8B	252
STMT72880-8B	252
STMT72881-8B	252
STMT72882-8B	252
STMT72883-8B	252
STMT72884-8B	252
STMT72885-8B	252
STMT72887-8B	253
STMT72888-8B	253
STMT72889-8B	253
STMT72890-8B	253
STMT72891-8B	253
STMT72892-8B	253
STMT72893-8B	253
STMT72894-8B	253
STMT72895-8B	262
STMT72896-8B	262
STMT72897-8B	262
STMT72898-8B	263
STMT72899-8B	263
STMT72900-8B	263
STMT72901-8B	263
STMT72902-8B	263
STMT72903-8B	263
STMT72904-8B	263
STMT72905-8B	263
STMT72906-8B	263
STMT72907-8B	263
STMT72908-8B	263
STMT72909-8B	263
STMT72910-8B	263
STMT72911-8B	263
STMT72912-8B	263
STMT72913-8B	263
STMT72914-8B	262
STMT72915-8B	262
STMT72916-8B	262
STMT72917-8B	262
STMT72918-8B	262
STMT72919-8B	262
STMT72920-8B	262

SKU #	Page
STMT72921-8B	262
STMT72922-8B	262
STMT72923-8B	262
STMT72924-8B	262
STMT72925-8B	262
STMT72926-8B	262
STMT72927-8B	262
STMT72928-8B	262
STMT72929-8B	262
STMT72930-8B	262
STMT72931-8B	262
STMT72932-8B	262
STMT72933-8B	275
STMT72934-8B	275
STMT72935-8B	275
STMT72936-8B	275
STMT72937-8B	275
STMT72938-8B	275
STMT72939-8B	275
STMT72940-8B	275
STMT72941-8B	275
STMT72942-8B	275
STMT72943-8B	275
STMT72944-8B	275
STMT72945-8B	275
STMT72946-8B	275
STMT72947-8B	275
STMT72948-8B	275
STMT72949-8B	275
STMT72950-8B	275
STMT72951-8B	275
STMT72952-8B	275
STMT72953-8B	275
STMT72954-8B	275
STMT72955-8B	275
STMT72956-8B	275
STMT72957-8B	275
STMT72958-8B	275
STMT72959-8B	276
STMT72960-8B	276
STMT72961-8B	276
STMT72962-8B	276
STMT72963-8B	276

SKU #	Page
STMT72964-8B	276
STMT72965-8B	276
STMT72966-8B	276
STMT72967-8B	276
STMT72968-8B	276
STMT72969-8B	276
STMT72970-8B	276
STMT72971-8B	276
STMT72972-8B	276
STMT72973-8B	276
STMT72974-8B	276
STMT72975-8B	276
STMT72976-8B	276
STMT72977-8B	276
STMT72978-8B	276
STMT72979-8B	276
STMT72980-8B	276
STMT72981-8B	276
STMT72982-8B	276
STMT72983-8B	276
STMT72984-8B	276
STMT73082-8B	251
STMT73197-8B	253
STMT73198-8B	253
STMT73199-8B	253
STMT73200-8B	253
STMT73201-8B	253
STMT73202-8B	253
STMT73203-8B	253
STMT73204-8B	253
STMT73205-8B	253
STMT73206-8B	253
STMT73207-8B	253
STMT73208-8B	253
STMT73209-8B	254
STMT73210-8B	254
STMT73211-8B	254
STMT73212-8B	254
STMT73213-8B	254
STMT73214-8B	254
STMT73215-8B	254
STMT73216-8B	254
STMT73217-8B	254

SKU #	Page
STMT73218-8B	254
STMT73219-8B	254
STMT73220-8B	254
STMT73221-8B	254
STMT73222-8B	254
STMT73224-8B	254
STMT73225-8B	255
STMT73226-8B	255
STMT73227-8B	255
STMT73228-8B	255
STMT73229-8B	255
STMT73230-8B	255
STMT73231-8B	255
STMT73232-8B	255
STMT73233-8B	257
STMT73234-8B	257
STMT73235-8B	257
STMT73236-8B	256
STMT73237-8B	256
STMT73238-8B	256
STMT73239-8B	257
STMT73240-8B	257
STMT73241-8B	257
STMT73242-8B	255
STMT73243-8B	255
STMT73244-8B	255
STMT73245-8B	255
STMT73246-8B	255
STMT73247-8B	255
STMT73248-8B	255
STMT73249-8B	255
STMT73250-8B	255
STMT73251-8B	255
STMT73252-8B	255
STMT73253-8B	256
STMT73254-8B	256
STMT73255-8B	256
STMT73256-8B	256
STMT73257-8B	256
STMT73258-8B	256
STMT73259-8B	256
STMT73260-8B	256
STMT73261-8B	263

SKU #	Page
STMT73262-8B	263
STMT73263-8B	263
STMT73264-8B	263
STMT73265-8B	263
STMT73266-8B	263
STMT73267-8B	263
STMT73268-8B	263
STMT73269-8B	263
STMT73270-8B	263
STMT73271-8B	263
STMT73272-8B	263
STMT73273-8B	263
STMT73274-8B	263
STMT73275-8B	263
STMT73276-8B	264
STMT73277-8B	264
STMT73278-8B	264
STMT73279-8B	264
STMT73280-8B	264
STMT73281-8B	264
STMT73282-8B	264
STMT73283-8B	264
STMT73284-8B	264
STMT73285-8B	264
STMT73286-8B	264
STMT73287-8B	264
STMT73288-8B	264
STMT73289-8B	264
STMT73290-8B	264
STMT73291-8B	264
STMT73292-8B	264
STMT73293-8B	264
STMT73294-8B	264
STMT73295-8B	265
STMT73296-8B	265
STMT73297-8B	265
STMT73298-8B	265
STMT73299-8B	265
STMT73300-8B	265
STMT73301-8B	265
STMT73302-8B	266
STMT73303-8B	266
STMT73304-8B	266

PRODUCT INDEX

ALPHA NUMERIC

SKU #	Page
STMT73305-8B	266
STMT73306-8B	266
STMT73307-8B	266
STMT73308-8B	266
STMT73309-8B	267
STMT73310-8B	267
STMT73311-8B	267
STMT73312-8B	267
STMT73313-8B	265
STMT73314-8B	265
STMT73315-8B	265
STMT73316-8B	265
STMT73317-8B	265
STMT73318-8B	265
STMT73319-8B	265
STMT73320-8B	265
STMT73321-8B	265
STMT73322-8B	265
STMT73323-8B	265
STMT73324-8B	277
STMT73325-8B	277
STMT73326-8B	277
STMT73327-8B	277
STMT73328-8B	277
STMT73329-8B	277
STMT73330-8B	277
STMT73331-8B	277
STMT73332-8B	277
STMT73333-8B	277
STMT73334-8B	277
STMT73335-8B	277
STMT73336-8B	277
STMT73337-8B	277
STMT73338-8B	277
STMT73339-8B	277
STMT73340-8B	277
STMT73341-8B	278
STMT73342-8B	278
STMT73343-8B	278
STMT73344-8B	278
STMT73345-8B	278
STMT73346-8B	278
STMT73347-8B	278

SKU #	Page
STMT73348-8B	278
STMT73349-8B	278
STMT73350-8B	278
STMT73351-8B	278
STMT73352-8B	278
STMT73354-8B	278
STMT73355-8B	278
STMT73356-8B	278
STMT73357-8B	278
STMT73358-8B	278
STMT73359-8B	278
STMT73360-8B	278
STMT73361-8B	278
STMT73362-8B	282
STMT73363-8B	282
STMT73364-8B	282
STMT73365-8B	282
STMT73366-8B	282
STMT73367-8B	282
STMT73368-8B	282
STMT73369-8B	282
STMT73370-8B	282
STMT73371-8B	279
STMT73372-8B	279
STMT73373-8B	279
STMT73374-8B	279
STMT73375-8B	279
STMT73376-8B	279
STMT73377-8B	279
STMT73378-8B	279
STMT73379-8B	279
STMT73380-8B	279
STMT73381-8B	279
STMT73382-8B	279
STMT73383-8B	279
STMT73384-8B	279
STMT73385-8B	279
STMT73386-8B	279
STMT73387-8B	279
STMT73388-8B	279
STMT73389-8B	280
STMT73390-8B	280
STMT73391-8B	280

SKU #	Page
STMT73392-8B	280
STMT73393-8B	280
STMT73394-8B	280
STMT73395-8B	280
STMT73396-8B	280
STMT73397-8B	280
STMT73398-8B	280
STMT73399-8B	280
STMT73400-8B	280
STMT73401-8B	280
STMT73402-8B	280
STMT73403-8B	280
STMT73404-8B	281
STMT73405-8B	281
STMT73406-8B	281
STMT73407-8B	281
STMT73408-8B	281
STMT73409-8B	281
STMT73410-8B	281
STMT73411-8B	281
STMT73412-8B	281
STMT73413-8B	281
STMT73414-8B	281
STMT73415-8B	281
STMT73416-8B	281
STMT73418-8B	281
STMT73419-8B	281
STMT73420-8B	281
STMT73421-8B	281
STMT73422-8B	282
STMT73423-8B	282
STMT73424-8B	282
STMT73425-8B	282
STMT73426-8B	282
STMT73427-8B	282
STMT73428-8B	282
STMT73429-8B	295
STMT73430-8B	295
STMT73431-8B	295
STMT73432-8B	295
STMT73433-8B	295
STMT73434-8B	295

SKU #	Page
STMT73435-8B	295
STMT73436-8B	295
STMT73437-8B	295
STMT73438-8B	295
STMT73439-8B	295
STMT73440-8B	295
STMT73441-8B	295
STMT73442-8B	295
STMT73443-8B	295
STMT73444-8B	296
STMT73445-8B	296
STMT73446-8B	296
STMT73447-8B	296
STMT73448-8B	296
STMT73449-8B	296
STMT73450-8B	296
STMT73451-8B	296
STMT73452-8B	296
STMT73453-8B	296
STMT73454-8B	296
STMT73455-8B	296
STMT73456-8B	296
STMT73457-8B	296
STMT73458-8B	296
STMT73459-8B	302
STMT73460-8B	302
STMT73461-8B	302
STMT73462-8B	302
STMT73463-8B	302
STMT73464-8B	304
STMT73465-8B	305
STMT73466-8B	305
STMT73467-8B	305
STMT73468-8B	305
STMT73469-8B	305
STMT73470-8B	305
STMT73471-8B	305
STMT73472-8B	305
STMT73473-8B	305
STMT73474-8B	305
STMT73475-8B	305
STMT73476-8B	305
STMT73477-8B	299

SKU #	Page
STMT73478-8B	299
STMT73479-8B	299
STMT73480-8B	299
STMT73481-8B	299
STMT73482-8B	299
STMT73483-8B	299
STMT73484-8B	299
STMT73485-8B	300
STMT73486-8B	300
STMT73487-8B	300
STMT73488-8B	300
STMT73489-8B	300
STMT73490-8B	300
STMT73491-8B	300
STMT73492-8B	300
STMT73493-8B	297
STMT73494-8B	297
STMT73495-8B	297
STMT73496-8B	298
STMT73497-8B	297
STMT73498-8B	303
STMT73499-8B	303
STMT73500-8B	303
STMT73501-8B	303
STMT73502-8B	294
STMT73503-8B	294
STMT73504-8B	294
STMT73505-8B	295
STMT73506-8B	294
STMT73507-8B	298
STMT73508-8B	299
STMT73509-8B	299
STMT73510-8B	299
STMT73511-8B	300
STMT73512-8B	300
STMT73513-8B	301
STMT73514-8B	301
STMT73515-8B	301
STMT73516-8B	301
STMT73517-8B	301
STMT73575-8	233
STMT73575-8B	233
STMT73587-8	313

SKU #	Page
STMT73588-8	313
STMT73589-8	314
STMT73590-8	314
STMT73591-8	315
STMT73592-8	315
STMT73647-8	225
STMT73648-8	226
STMT73649-8	226
STMT73663-8	226
STMT73664-8	227
STMT73852-8	316
STMT73853-8	316
STMT73854-8	316
STMT73855-8	316
STMT73914-8	292
STMT73915-8	293
STMT73916-8	293
STMT73917-8	293
STMT73918-8	292
STMT73919-8	292
STMT73982-8	249
STMT73982-8B	249
STMT73983-8	258
STMT73983-8B	258
STMT73984-8	271
STMT73984-8B	271
STMT74173-8	270
STMT74173-8C	218/269
STMT74174-8	258
STMT74175-8	248
STMT74175-8C	218/248
STMT74176-8	271
STMT74177-8	227
STMT74178-8	227
STMT74179-8	153
STMT74180-8	153
STMT74181-8	167
STMT74182-8	167
STMT74183-8	268
STMT74184-8	268
STMT74393-8	241
STMT74394-8	242
STMT74726-8	270

SKU #	Page
STMT74726-8C	219
STMT74840-8	321
STMT74897-8C	228
STMT74901-8	316
STMT74902-8	316
STMT75095-8C	247
STMT78020-8	332
STMT78056-8	326
STMT78214-8	331
STMT78221-8	331
STMT78228-8	332
STMT78229-8	332
STMT78241-8	332
STMT78401-8	325
STMT79101-8	228
STMT79101-8B	228
STMT79102-8	228
STMT79102-8B	228
STMT79103-8	228
STMT79103-8B	228
STMT79104-8	228
STMT79104-8B	228
STMT79105-8	228
STMT79105-8B	228
STMT79106-8	228
STMT79106-8B	228
STMT79107-8	228
STMT79107-8B	228
STMT79108-8	228
STMT79108-8B	228
STMT79109-8	228
STMT79109-8B	228
STMT79110-8	228
STMT79110-8B	228
STMT79111-8	228
STMT79111-8B	228
STMT79112-8	228
STMT79112-8B	228
STMT79113-8	228
STMT79113-8B	228
STMT79114-8	228
STMT79114-8B	228
STMT79115-8	228

SKU #	Page
STMT79115-8B	228
STMT79116-8	228
STMT79116-8B	228
STMT79117-8	228
STMT79117-8B	228
STMT79118-8	228
STMT79118-8B	228
STMT79119-8	228
STMT79119-8B	228
STMT79120-8B	228
STMT79121-8B	228
STMT79122-8B	228
STMT80012-8B	233
STMT86001-8B	250
STMT86002-8B	251
STMT86006-8B	250
STMT86007-8B	250
STMT86010-8B	250
STMT86011-8B	252
STMT86124-8B	251
STMT86202-8B	259
STMT86206-8B	259
STMT86207-8B	259
STMT86208-8B	259
STMT86211-8B	260
STMT86212-8B	261
STMT86213-8B	261
STMT86214-8B	260
STMT86215-8B	260
STMT86250-8B	260
STMT86395-8B	249
STMT86396-8B	259
STMT86397-8B	272
STMT86405-8B	274
STMT86407-8B	272
STMT86408-8B	272
STMT86410-8B	272
STMT86411-8B	273
STMT86412-8B	273
STMT86414-8B	273
STMT86493-8B	274
STMT87431-8	234
STMT87432-8	234

PRODUCT INDEX

ALPHA NUMERIC

SKU #	Page
STMT87433-8	234
STMT87434-8	234
STMT87435-8	234
STMT87500-8B	302
STMT87501-8B	302
STMT87502-8B	302
STMT87504-8B	302
STMT87505-8B	302
STMT87507-8B	302
STMT87508-8B	302
STMT88558-8B	273
STMT88908-8B	284
STMT88909-8B	284
STMT88930-8B	272
STMT88941-8B	261
STMT88996-8B	274
STMT89302-8B	284
STMT89303-8B	283
STMT89306-8B	283
STMT89307-8B	283
STMT89319-8B	285
STMT89322-8B	285
STMT89324-8B	285
STMT89325-8B	285
STMT89327-8B	285
STMT89328-8B	285
STMT89330-8B	285
STMT89332-8B	285
STMT89333-8B	285
STMT89334-8B	285
STMT89336-8B	285
STMT89338-8B	285
STMT89341-8B	285
STMT89346-8B	285
STMT89350-8B	285
STMT89395-8B	304
STMT89396-8B	304
STMT89397-8B	304
STMT89398-8B	304
STMT89399-8B	304
STMT89400-8B	304
STMT89401-8B	304
STMT89402-8B	304

SKU #	Page
STMT89403-8B	304
STMT89404-8B	304
STMT89405-8B	304
STMT89406-8B	304
STMT89407-8B	304
STMT89408-8B	304
STMT89409-8B	304
STMT89410-8B	304
STMT89411-8B	304
STMT89412-8B	304
STMT89413-8B	304
STMT89414-8B	304
STMT89415-8B	304
STMT89416-8B	304
STMT89417-8B	304
STMT89419-8B	304
STMT89420-8B	304
STMT89421-8B	304
STMT89422-8B	304
STMT89423-8B	304
STMT89424-8B	304
STMT89425-8B	304
STMT89426-8	305
STMT89427-8B	305
STMT89428-8B	305
STMT89429-8B	305
STMT89430-8B	305
STMT89431-8B	305
STMT89432-8B	305
STMT89433-8B	305
STMT89435-8B	301
STMT89436-8B	301
STMT89437-8B	301
STMT89438-8B	301
STMT89439-8B	301
STMT89440-8B	301
STMT89441-8B	301
STMT89442-8B	301
STMT89443-8B	301
STMT89444-8B	301
STMT89445-8B	301
STMT89446-8B	301
STMT89447-8B	301

SKU #	Page
STMT89448-8B	301
STMT89449-8B	301
STMT89450-8B	301
STMT89451-8B	301
STMT89452-8B	301
STMT89453-8B	301
STMT89454-8B	301
STMT89455-8B	301
STMT89456-8B	301
STMT89457-8B	301
STMT89458-8B	301
STMT89619-8B	286
STMT89621-8B	286
STMT89622-8B	286
STMT89623-8B	286
STMT89624-8B	286
STMT89625-8B	286
STMT89626-8B	286
STMT89627-8B	286
STMT89628-8B	286
STMT89629-8B	286
STMT89630-8B	286
STMT89632-8B	286
STMT89633-8B	286
STMT89634-8B	286
STMT89635-8B	286
STMT89636-8B	286
STMT89638-8B	286
STMT89640-8B	286
STMT89641-8B	286
STMT89642-8B	286
STMT89644-8B	286
STMT89646-8B	286
STMT89650-8B	286
STMT89654-8B	286
STMT89655-8B	286
STMT89658-8B	286
STMT89660-8B	286
STMT89661-8B	287
STMT89662-8B	287
STMT89663-8B	287
STMT89664-8B	287
STMT89665-8B	287

SKU #	Page
STMT89666-8B	287
STMT89667-8B	287
STMT89668-8B	287
STMT89669-8B	287
STMT89670-8B	287
STMT89671-8B	287
STMT89672-8B	287
STMT89673-8B	287
STMT89674-8B	287
STMT89675-8B	287
STMT89676-8B	287
STMT89677-8B	287
STMT89678-8B	287
STMT89679-8B	287
STMT89817-8B	249
STMT89818-8B	258
STMT89819-8B	271
STMT89934-8B	233
STMT89935-8B	233
STMT89936-8B	233
STMT89937-8B	233
STMT89938-8B	233
STMT89939-8B	233
STMT89940-8B	233
STMT89941-8B	233
STMT89942-8B	233
STMT89943-8B	233
STMT89944-8B	233
STMT90062-8	331
STMT91059-8B	250
STMT91316-8B	283
STMT91339-8B	250
STMT91379-8B	302
STMT91380-8B	302
STMT91391-8B	302
STMT91392-8B	302
STMT91393-8B	302
STMT91394-8B	302
STMT91395-8B	302
STMT91396-8B	302
STMT91397-8B	302
STMT91398-8B	302
STMT91403-8B	302

SKU NUMBER CHANGES LIST

OLD SKU #	NEW SKU #	DESCRIPTION	PAGE
0-10-280	10-280-0	KNIFE SNAP OFF BLADE 18MM	116
10-131	10-131-S	KNIFE S/O 9 MM	118
10-143	10-143-S	KNIFE S/O 18 MM	118
10-480	0-10-480	18MM SNAP OFF CARTRIDGE KNIFE	115
1-11-301	11-301T	KNIFE BLADES 18MM 10PCS/	120
11-983	0-11-983	KNIFE-BLADE HOOK (5PCS/PK)	121
12-020-1	1-12-020	PLANE-BLOCK 9 1/2	210
12-060-1	1-12-060	PLANE-BLOCK 60 1/2	210
12-102-1	1-12-102	PLANE-BLOCK NO.102	211
12-312-1	0-12-312	IRON-SINGLE 45MM 1 3/4" CARDED	210
14-308	14-308-S	BOLT CUTTER-FORGED HANDLE 8"	129
14-312	14-312-S	BOLT CUTTER-FORGED HANDLE 12"	129
14-314	14-314-S	BOLT CUTTER-FORGED HANDLE 14"	129
14-318	14-318-S	BOLT CUTTER-TUBULAR HANDLE 18"	129
14-324	14-324-S	BOLT CUTTER-TUBULAR HANDLE 24"	129
14-330	14-330-S	BOLT CUTTER-TUBULAR HANDLE 30"	129
14-336	14-336-S	BOLT CUTTER-TUBULAR HANDLE 36"	129
15-265	15-265-S	RUBBER GRIP HACKSAW ADJ. FRAME	122
15-565	15-565-S	HACKSAW ADJ 10"/225MM	122
15-982-23	15-982	HACKSAW HSS SAW BLADE 32Tx12" (x100)	127
15-988-23	15-988	HACKSAW HSS SAW BLADE 18Tx12" (x100)	127
20-175-23	20-175	HACKSAW BLADE BI-METAL 18Tx12" (x100)	127
20-176-23	20-176	HACKSAW BLADE BI-METAL 24Tx12" (x100)	127
20-177-23	20-177	HACKSAW BLADE BI-METAL 32Tx12" (x100)	127
21-102-5-11	5-21-102	SURFORM-FLAT FILE 5 1/2"	211
21-103-5-11	5-21-103	SURFORM-PLANE 10"	211
21-104-5-11	5-21-104	SURFORM-BLOCK PLANE 5 1/2"	211
21-115-5-11	5-21-115	SURFORM-SHAVER TOOL 2 1/2"	212
21-293-5-11	5-21-293	SURFORM STD CUT BLADE	213
21-299-5-11	5-21-299	SURFORM-1/2 ROUND BLD	213
21-393-5-11	5-21-393	SURFORM FINE CUT BLADE	213

OLD SKU #	NEW SKU #	DESCRIPTION	PAGE
21-398-5-11	5-21-398	SURFORM FINE CUT BLADE 5	213
21-508-5-11	5-21-508	SURFORM-MET PLAST BLD	213
21-515-5-11	5-21-515	SURFORM-STD BLD CLAMSHELL	213
29-045-1	1-29-045	ROLLER FRAME 9" CAGE x 1/2"	208
29-069-1	1-29-069	PAINT ROLLER COMPLETE 9"	208
29-076-1	1-29-076	ROLLER FRAME 7" STICK	208
29-078-5	2-29-078	ROLLER REFILL MINI ACRYLIC	208
29-086-0	0-29-086	STICK ROLLER 4"	208
29-256-0	0-29-256	ROLLER REFILL 7" MOGLOSS-STICK	208
29-277-0	0-29-277	ROLLER REFILL 9" ACRYLIC YS	208
29-494-1	1-29-494	PAINT ROLLER COMPLETE 7"	208
43-524	1-43-524	FATMAX II LEVEL	79
66-119	66-119-S	S/DVR -SPARK TESTING 150MM PP	173
66-120	66-120-S	SPARK DETECTING S/D 100-500V	173
66-137	66-137-S	DIGITAL VOLTAGE TESTER	173
79-064	79-064-S	WRENCH RV MULTI GEAR 72TH 8MM	231
79-065	79-065-S	WRENCH RV MULTI GEAR 72TH 9MM	231
79-066	79-066-S	WRENCH RV MULTI GEAR 72TH 10MM	231
79-068	79-068-S	WRENCH RV MULTI GEAR 72TH 12MM	231
79-069	79-069-S	WRENCH RV MULTI GEAR 72TH 13MM	231
79-070	79-070-S	WRENCH RV MULTI GEAR 72TH 14MM	231
86-478-1	86-478	SKT SET 1/2"DR 26PC 12PT IMP	244
87-057-1	87-057	WRENCH COMB SL 07MM	230
87-058-1	87-058	WRENCH COMB SL 08MM	230
87-066-1	87-066	WRENCH COMB SL 06MM	230
87-069-1	87-069	WRENCH COMB SL 09MM	230
87-070-1	87-070	WRENCH COMB SL 10MM	230
87-071-1	87-071	WRENCH COMB SL 11MM	230
87-072-1	87-072	WRENCH COMB SL 12MM	230
87-073-1	87-073	WRENCH COMB SL 13MM	230

OLD SKU #	NEW SKU #	DESCRIPTION	PAGE
87-074-1	87-074	WRENCH COMB SL 14MM	230
87-075-1	87-075	WRENCH COMB SL 15MM	230
87-076-1	87-076	WRENCH COMB SL 16MM	230
87-077-1	87-077	WRENCH COMB SL 17MM	230
87-078-1	87-078	WRENCH COMB SL 18MM	230
87-079-1	87-079	WRENCH COMB SL 19MM	230
87-080-1	87-080	WRENCH COMB SL 20MM	230
87-081-1	87-081	WRENCH COMB SL 21MM	230
87-082-1	87-082	WRENCH COMB SL 22MM	230
87-083-1	87-083	WRENCH COMB SL 23MM	230
87-084-1	87-084	WRENCH COMB SL 24MM	230
87-087-1	87-087	WRENCH COMB SL 27MM	230
87-090-1	87-090	WRENCH COMB SL 30MM	230
87-092-1	87-092	WRENCH COMB SL 32MM	230
87-096-1	87-096	WRENCH O/E SL 6X7MM	231
87-430	87-430-1-S	ADJUSTABLES WRENCHES 4"	234
87-617-1	87-617-3	WR SET BOX END 75DEG 10PC MET	224
87-620-23	87-620-5	WRENCH PIPE 6"	155
87-621-23	87-621-5	WRENCH PIPE 8"	155
87-622-23	87-622-5	WRENCH PIPE 10"	155
87-623-23	87-623-5	WRENCH PIPE 12"	155
87-624-23	87-624-5	WRENCH PIPE 14"	155
87-625-23	87-625-5	WRENCH PIPE 18"	155
87-626-23	87-626-5	WRENCH PIPE 24"	155
87-627-23	87-627-5	WRENCH PIPE 36"	155
87-629-23	87-629-5	WRENCH PIPE 48"	155
87-710	87-710-1	RATCHET 1/4"DR FLIP DRIVE	247
87-715	87-715-1	RATCHET3/8"DR FLIP DRIVE 203MM	247
87-720	87-720-1	RATCHET 1/2"DR FLIP DRIVE	247
89-033	89-033-1	SKT SET 1/4"DR 35PC 6PT MET	244
89-101-1	89-101	SKT SET 3/4"DR 19PC 12PT MET	245
89-518	89-518-1	SKT SET 1/4"DR & 3/8"DR 37PC	244
95-294-23	95-294	HACKSAW HSS SAW BLADE 18Tx12" (x10)	127
95-295-23	95-295	HACKSAW HSS SAW BLADE 24Tx12" (x10)	127
95-296-23	95-296	HACKSAW HSS SAW BLADE 32Tx12" (x10)	127
95-297-23	95-297	HACKSAW BLADE BI-METAL 18Tx12" (x10)	127

OLD SKU #	NEW SKU #	DESCRIPTION	PAGE
95-298-23	95-298	HACKSAW BLADE BI-METAL 24Tx12" (x10)	127
95-299-23	95-299	HACKSAW BLADE BI-METAL 32Tx12" (x10)	127
95-385	95-385-IV	BRACING GREASEGUN- IMPROVED VERSION	333
TRA204	TRA204T	STAPLES 1/4" (6MM) LIGHT DUTY	186
TRA205	TRA205T	STAPLES 5/16" (MM) LIGHT DUTY	186
TRA206	TRA206T	STAPLES 3/8" (MM) LIGHT DUTY	186

DISPLAYS

TABLE TOP DISPLAY



Enclosed Counter Unit



Modular CTU Laser Hook Display



Modular CTU Laser Hero Plint + 7" Screen



Screwdriver CTU

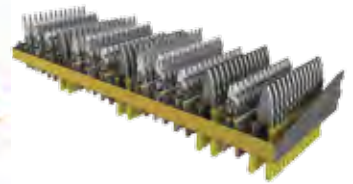

Pliers Shelf

FREE STANDING DISPLAY



Hammer Display



Modular Hammer Drill



Mini Rotator



Tower Display



200mm On Fixture Hopper



Counter Top Cages

FLOOR DISPLAY



0.5m Floor-Stand
(Available in 1m size)



Universal Island



Deluxe Innocentre Kit



Q-Pallet



Rotary Laser Cabinet Assembly



Steel Basket



Pallet

STANLEY® AIR TOOLS WARRANTY POLICY

STANLEY® is confident of the quality of its products and therefore offers an outstanding Warranty to users. The Warranty statement is in addition to and does not prejudice the contractual rights of professional users or the statutory rights of private non-professional users dealing as consumers. The Warranty we provide users with their product reminds them of their rights and complies with the requirements of the law on consumer guarantees.

STANLEY® will repair, without charge, any defects due to defective materials or workmanship within 12 months from the date of purchase.

- The Warranty does not cover part failure due to excessive wear and tear or tool misuse.
- The Warranty does not apply where repairs have been attempted by unauthorized persons.

Defective materials or workmanship

STANLEY® applies very high quality standards to its suppliers and manufacturing operations, and 100% of all products are tested prior to leaving the factory. There are however, rare occasions where a product defect occurs.

Where it can be verified to your satisfaction that a product defect was caused by either

- a) Incorrect assembly by the manufacturer or,
- b) Failure of the manufacturer to manufacture one or more product components to design specification limits then STANLEY's Warranty provides for the repair of such a defect to the product at no charge to the user.

What is not covered?

The STANLEY® Warranty does not cover components that are subject to "Excessive Wear and Tear".

The term "Wear and Tear" refers to the number of hours that a product has been used and the environment it has been used in. The extent of Wear and Tear for any product will be determined by the Authorized Service Center.

In addition to the "Wear and Tear" statement on our products, vanes, gaskets and O-rings, are not covered under Warranty, unless defective during manufacturing, to be determined by the Authorized Service Center

Tool misuse

Examples of tool misuse include:

- Extreme impacts or drops
- Ingestion of foreign objects, for example nails, screws, sand, liquids, etc.
- Using the wrong tool for the application
- Prolonged exposure to the environment
- Lack of recommended service
- Damages caused by poor maintenance of air compressor and air lines.

Service attempted by unauthorized persons

Under no circumstances during the Warranty period should a customer attempt to service their own tool. Any such attempt invalidates the Warranty for said tool.

Warranty repairs should only be carried out through an Authorized STANLEY® Service Center.

NOTES



NOTES

STANLEY®

ADDRESS: